



# XBee<sup>®</sup>/XBee-PRO S2C ZigBee<sup>®</sup>

RF Module

---

User Guide

## Revision history—90002002

---

Revision	Date	Description
S	May 2015	Update the SMT dimensions drawing. Added a section on deep sleep and sleep current measurements. Updated the baud rates supported by the BD command. Updated the Brazil ANATEL certification information.
T	July 2015	Revised the Maximum RF payload size section. Frames 0x90 and 0x91 no longer report the 0x40 indicator - removed it.
U	December 2015	Updated XBee-PRO surface-mount agency approvals. Added missing Extended Modem Status status code descriptions to the 0x98 frame. Added ANATEL labels.
V	July 2016	Updated the firmware release notes section. Updated several hardware specifications with S2D hardware information. Updated regulatory information. Revised the Programmable XBee SDK section. Added the ED command. Updated the BD command. Added antennas for the S2D hardware. Added a section on loading ZB firmware. Added “S2C” to the product name on the title page and throughout the document. Updated the number of supported address table entries.

## Trademarks and copyright

Digi, Digi International, and the Digi logo are trademarks or registered trademarks in the United States and other countries worldwide. All other trademarks mentioned in this document are the property of their respective owners.

© 2016 Digi International Inc. All rights reserved.

## Disclaimers

Information in this document is subject to change without notice and does not represent a commitment on the part of Digi International. Digi provides this document “as is,” without warranty of any kind, expressed or implied, including, but not limited to, the implied warranties of fitness or merchantability for a particular purpose. Digi may make improvements and/or changes in this manual or in the product(s) and/or the program(s) described in this manual at any time.

## Warranty

To view product warranty information, go to the following website:

[www.digi.com/howtobuy/terms](http://www.digi.com/howtobuy/terms)

## Send comments

**Documentation feedback:** To provide feedback on this document, send your comments to [techcomm@digi.com](mailto:techcomm@digi.com).

## Customer support

**Digi Technical Support:** Digi offers multiple technical support plans and service packages to help our customers get the most out of their Digi product. For information on Technical Support plans and pricing, contact us at +1 952.912.3444 or visit us at [www.digi.com/support](http://www.digi.com/support).

Support portal login: [www.digi.com/support/eservice](http://www.digi.com/support/eservice)

# Contents

---

## XBee/XBee-PRO® S2C ZigBee® RF Module

Note on product naming .....	14
Applicable firmware and hardware .....	14
Firmware release notes .....	14

## Technical specifications

Performance specifications .....	16
Power requirements .....	16
General specifications .....	16
Networking and security specifications .....	17
Interface options .....	17
Agency approvals .....	17
Serial communication specifications .....	18
UART pin assignments .....	18
SPI pin assignments .....	19
GPIO specifications .....	19
Hardware specifications for the programmable variant .....	20
Mechanical drawings .....	20
Pin signals for the surface-mount module .....	22
Pin signals for the through-hole module .....	24
EM357 pin mappings .....	25
Design notes .....	26
Power supply design .....	26
Board layout .....	27
Antenna performance .....	27
Recommended pin connections .....	28
Design notes for PCB antenna devices .....	28
Surface-mount keepout area .....	28
Through-hole keepout area .....	29
Design notes for SMT RF pad devices .....	30
Module operation for the programmable variant .....	32
Programmable XBee SDK .....	32
Programmable connections .....	34

## Operation

Serial interface .....	37
UART data flow .....	37
Serial data .....	37
SPI communications .....	38
SPI operation .....	38
Serial port selection .....	39

Serial buffers .....	39
Serial receive buffer .....	40
Serial transmit buffer .....	40
UART flow control .....	40
CTS flow control .....	40
RTS flow control .....	41
Break control .....	41
Serial interface protocols .....	41
Transparent operation .....	41
API operation .....	41
Compare Transparent and API operation .....	42
Modes of operation .....	44
Idle mode .....	45
Transmit mode .....	45
Receive mode .....	47
Command mode .....	47
Sleep Mode .....	48

## ZigBee networks

Introduction to XBee devices .....	50
ZigBee stack layers .....	50
ZigBee networking concepts .....	51
Device types .....	51
PAN ID .....	53
Operating channels .....	54
Zigbee application layers: in depth .....	54
Application Support Sublayer (APS) .....	54
Application profiles .....	54
ZigBee coordinator operation .....	56
Forming a network .....	56
Security policy .....	56
Channel selection .....	56
PAN ID selection .....	56
Persistent data .....	56
Coordinator startup .....	57
Permit joining .....	58
Resetting the coordinator .....	58
Leave a network .....	59
Replacing a coordinator (security disabled only) .....	59
Example: start a coordinator .....	60
Example: replace a coordinator (security disabled) .....	60
ZigBee router operation .....	61
Discovering ZigBee networks .....	61
Joining a network .....	61
Persistent data .....	61
ZigBee router joining .....	62
Permit joining .....	63
Router network connectivity .....	63
End device operation .....	66
Discover ZigBee networks .....	67
Joining a network .....	67
End device capacity .....	67
Persistent data .....	68
Orphan scans .....	68

End device joining .....	68
Parent connectivity .....	69
Resetting the end device .....	69
Leaving a network .....	70
Example: joining a network .....	70
ZigBee channel scanning .....	71
Managing multiple ZigBee networks .....	71
PAN ID filtering .....	71
Pre-configured security keys .....	71
Permit joining .....	71
Application messaging .....	72

## Transmission, addressing, and routing

Addressing .....	74
64-bit device addresses .....	74
16-bit device addresses .....	74
Application layer addressing .....	74
Data transmission .....	74
Broadcast transmissions .....	74
Unicast transmissions .....	75
Address resolution .....	76
Address table .....	76
Group table .....	77
Binding transmissions .....	77
Address resolution .....	77
Binding table .....	78
Multicast transmissions .....	78
Address resolution .....	78
Fragmentation .....	78
Data transmission examples .....	78
AT firmware .....	79
API firmware .....	79
API frame .....	80
RF packet routing .....	81
Link status transmission .....	81
AODV mesh routing .....	82
Many-to-One routing .....	85
High/Low RAM Concentrator mode .....	85
Source routing .....	85
Encrypted transmissions .....	90
Maximum RF payload size .....	90
Throughput .....	92
ZDO transmissions .....	93
ZDO .....	93
Sending a ZDO command .....	93
Receiving ZDO command and responses .....	93
Transmission timeouts .....	95
Unicast timeout .....	96
Extended timeout .....	96
Transmission examples .....	97

## ZigBee security

Security modes .....	100
ZigBee security model .....	100
Network layer security .....	100
APS layer security .....	101
Trust center .....	103
Forming or joining a secure network .....	103
Implementing security on the XBee .....	103
Enabling security .....	104
Setting the network security key .....	104
Set the APS trust center link key .....	104
Enable APS encryption .....	104
Use a trust center .....	105
Security examples .....	105

## Network commissioning and diagnostics

Place devices .....	107
Device discovery .....	107
Network discovery .....	107
ZDO discovery .....	107
Joining Announce .....	108
Commissioning pushbutton and associate LED .....	108
Commissioning pushbutton .....	108
Associate LED .....	109
Binding .....	110
Group Table API .....	113

## Managing End Devices

End Device operation .....	123
Parent operation .....	123
End Device poll timeouts .....	124
Packet buffer usage .....	124
Non-Parent device operation .....	124
XBee End Device configuration .....	125
Pin sleep .....	126
Cyclic sleep .....	127
Recommended sleep current measurements .....	132
Achieve the lowest sleep current .....	132
Compensate for switching time .....	132
Internal pin pull-ups .....	133
Transmitting RF data .....	133
Receiving RF data .....	133
I/O sampling .....	134
Waking end devices with the Commissioning Pushbutton .....	134
Parent verification .....	134
Rejoining .....	134
Router/Coordinator configuration .....	135
RF packet buffering timeout .....	135
Child poll timeout .....	135
Transmission timeout .....	136
Putting it all together .....	137

Short sleep periods .....	137
Extended sleep periods .....	137
Sleep examples .....	137

## Analog and digital I/O lines

Configurable I/O pins and configuration commands .....	140
XBee ZB through-hole RF module .....	140
I/O Configuration .....	141
I/O sampling .....	142
Queried sampling .....	143
Periodic I/O sampling .....	144
Change detection sampling .....	144
RSSI PWM .....	144
I/O examples .....	145
PWM1 .....	145

## API Operation

API frame format .....	147
API operation (AP parameter = 1) .....	147
API operation-with escaped characters (AP parameter = 2) .....	147
Data bytes that need to be escaped: .....	148
Length .....	148
Frame data .....	148
Calculate and verify checksums .....	149
API examples .....	149
API serial port exchanges .....	150
AT commands .....	151
Transmit and Receive RF data .....	151
Remote AT commands .....	151
Source routing .....	152
Frame descriptions .....	153
AT Command frame - 0x08 .....	154
AT Command - Queue Parameter Value frame - 0x09 .....	155
Transmit Request frame - 0x10 .....	157
Explicit Addressing Command frame - 0x11 .....	161
Remote AT Command Request frame - 0x17 .....	164
Create Source Route - 0x21 .....	166
AT Command Response frame - 0x88 .....	169
Modem Status frame - 0x8A .....	171
Transmit Status frame - 0x8B .....	172
Receive Packet frame - 0x90 .....	174
Explicit Rx Indicator frame - 0x91 .....	176
Data Sample Rx Indicator frame - 0x92 .....	178
XBee Sensor Read Indicator - 0x94 .....	181
Node Identification Indicator frame - 0x95 .....	184
Remote Command Response frame - 0x97 .....	187
Extended Modem Status frame - 0x98 .....	189
Over-the-Air Firmware Update Status - 0xA0 .....	196
Route Record Indicator - 0xA1 .....	198
Many-to-One Route Request Indicator - 0xA3 .....	200
Send ZDO commands with the API .....	201
Example .....	203



Send ZigBee Cluster Library (ZCL) commands with the API .....	204
Example .....	207
Send Public Profile Commands with the API .....	209
Frame specific data .....	209
Example .....	212

## AT commands

DH (Destination Address High) .....	216
DL (Destination Address Low) .....	216
MY (16-bit Network Address) .....	216
MP (16-bit Parent Network Address) .....	216
NC (Number of Remaining Children) .....	217
SH (Serial Number High) .....	217
SL (Serial Number Low) .....	217
NI (Node Identifier) .....	217
SE (Source Endpoint) .....	218
DE (Destination Endpoint) .....	218
CI (Cluster ID) .....	218
TO (Transmit Options) .....	218
NP (Maximum Packet Payload Bytes) .....	219
DD (Device Type Identifier) .....	219
CR (Conflict Report) .....	219
Network commands .....	220
CH (Operating Channel) .....	220
CE (Coordinator Enable) .....	220
ID (Extended PAN ID) .....	220
OP (Operating Extended PAN ID) .....	221
NH (Maximum Unicast Hops) .....	221
BH (Broadcast Hops) .....	221
OI (Operating 16-bit PAN ID) .....	221
NT (Node Discover Timeout) .....	221
NO (Network Discovery Options) .....	222
SC (Scan Channels) .....	222
SD (Scan Duration) .....	223
ZS (ZigBee Stack Profile) .....	225
NJ (Node Join Time) .....	225
JV (Channel Verification) .....	225
NW (Network Watchdog Timeout) .....	226
JN (Join Notification) .....	226
AR (Aggregate Routing Notification) .....	226
Security commands .....	227
EE (Encryption Enable) .....	227
EO (Encryption Options) .....	227
NK (Network Encryption Key) .....	227
KY (Link Key) .....	228
RF interfacing commands .....	228
PL (TX Power Level) .....	228
PM (Power Mode) .....	229
DB (Received Signal Strength) .....	229
PP (Peak Power) .....	229
Serial interfacing commands .....	230
AP (API Enable) .....	230
AO (API Options) .....	230
BD (Interface Data Rate) .....	230

NB (Parity)	231
SB (Stop Bits)	232
RO (Packetization Timeout)	232
D6 (DIO6/RTS)	233
I/O settings commands	233
IR (I/O Sample Rate)	233
IC (Digital Change Detection)	233
P0 (RSSI/PWM0 Configuration)	234
P1 (DIO11/PWM1 Configuration)	235
P2 (DIO12 Configuration)	235
P3 (DIO13/DOOUT Configuration)	235
P4 (DIO14/DIN)	236
P5 (DIO15/SPI_MISO)	236
P6 (DIO16/SPI_MOSI)	237
P7 (DIO17/SPI_SSEL)	237
P8 (DIO18/SPI_SCLK)	237
P9 (DIO19/SPI_ATTEN/PTI_DATA)	237
D0 (AD0/DIO0 Configuration)	238
D1 (AD1/DIO1/PTI_En Configuration)	238
D2 (AD2/DIO2 Configuration)	238
D3 (AD3/DIO3 Configuration)	239
D4 (DIO4 Configuration)	239
D5 (DIO5/Associate Configuration)	240
D8 (DIO8/DTR/SLP_RQ)	240
D9 (DIO9/ON_SLEEP)	241
LT (Associate LED Blink Time)	241
PR (Pull-up/Down Resistor Enable)	241
PD (Pull Up/Down Direction)	242
RP (RSSI PWM Timer)	242
DC (Device Controls)	243
DO (Device Options)	243
%V (Voltage Supply Monitoring)	244
V+ (Voltage Supply Monitoring)	244
Diagnostic commands	244
VR (Firmware Version)	245
VL (Version Long)	245
HV (Hardware Version)	245
AI (Association Indication)	245
Command mode options	246
CT (Command Mode Timeout)	246
CN (Exit Command mode)	246
GT (Guard Times)	247
CC (Command Character)	247
Sleep commands	247
SM (Sleep Mode)	247
SN (Number of Cycles Between ON_SLEEP)	248
SP (Sleep Period)	248
ST (Time before Sleep)	248
SO (Sleep Options)	248
WH (Wake Host Delay)	249
PO (Polling Rate)	249
Execution commands	250
AC (Apply Changes)	250
AS (Active Scan)	250
WR (Write)	250

RE (Restore Defaults) .....	251
FR (Software Reset) .....	251
NR (Network Reset) .....	251
SI (Sleep Immediately) .....	251
CB (Commissioning Pushbutton) .....	252
&X (Clear Binding and Group Tables) .....	252
ND (Node Discovery) .....	252
DN (Destination Node) .....	253
IS (Force Sample) .....	254

## Module support

XCTU configuration tool .....	256
Customizing XBee ZigBee firmware .....	256
Design considerations for Digi drop-in networking .....	256
XBee Bootloader .....	256
Programming XBee modules .....	257
Serial firmware updates .....	257
Invoke the XBee Bootloader .....	257
Send a firmware image .....	257
Writing custom firmware .....	258
Regulatory compliance .....	258
Enable GPIO 1 and 2 .....	258
Detect XBee versus XBee-PRO .....	259
Special instructions for using the JTAG interface .....	259

## Certifications

United States (FCC) .....	261
OEM labeling requirements .....	261
FCC notices .....	262
FCC-approved antennas (2.4 GHz) .....	263
Associated antenna descriptions .....	280
RF exposure .....	280
Europe .....	280
OEM labeling requirements .....	280
Declarations of conformity .....	281
Antennas .....	281
IC (Industry Canada) Certification .....	281
Labeling requirements .....	281
For XBee ZB surface-mount: .....	281
For XBee-PRO ZB surface-mount: .....	281
For XBee ZB through-hole: .....	282
For XBee-PRO ZB through-hole: .....	282
Transmitters for detachable antennas .....	282
Detachable antenna .....	282
For XBee S2D SMT: .....	282
RF Exposure .....	282
Australia (RCM) .....	283
ANATEL (Brazil) certification .....	283

## Migrating from XBee through-hole to XBee surface-mount devices

Pin mapping .....	287
Mounting .....	288

## Manufacturing information

Recommended solder reflow cycle .....	291
Recommended footprint .....	291
Flux and cleaning .....	293
Reworking .....	293

## Load ZB firmware on 802.15.4 devices

Background .....	295
Load ZB firmware .....	296

## Definitions

ZigBee node types .....	297
ZigBee protocol .....	298

# **XBee/XBee-PRO® S2C ZigBee® RF Module**

---

This manual describes the operation of the XBee/XBee-PRO ZigBee RF Module, which consists of ZigBee firmware loaded onto XBee S2C and PRO S2C hardware.

The XBee/XBee-PRO ZigBee RF Modules provide wireless connectivity to end-point devices in ZigBee mesh networks. Using the ZigBee PRO Feature Set, these modules are inter-operable with other ZigBee devices, including devices from other vendors. With the XBee, users can have their ZigBee network up-and-running in a matter of minutes without configuration or additional development.

The XBee/XBee-PRO ZigBee RF Modules are compatible with other devices that use XBee ZigBee technology. These include ConnectPortX gateways, XBee and XBee-PRO Adapters, Wall Routers, XBee Sensors, and other products with the ZB name.

Note on product naming .....	14
Applicable firmware and hardware .....	14
Firmware release notes .....	14

## **Note on product naming**

Although we refer to the device as an S2C, information for the S2D is also part of the guide. The information for the S2D is part of the S2C guide because the hardware is very similar.

## **Applicable firmware and hardware**

Hardware: S2C

Firmware: 401x, 402x, 403x, 404x, 405x

Hardware: S2D

Firmware: 705x

## **Firmware release notes**

You can view the current release notes in the Firmware Explorer section of XCTU. For instructions on downloading and using XCTU, go to: <http://www.digi.com/products/xbee-rf-solutions/xctu-software/xctu>.

## Technical specifications

---

Performance specifications .....	16
Power requirements .....	16
General specifications .....	16
Networking and security specifications .....	17
Interface options .....	17
Agency approvals .....	17
Serial communication specifications .....	18
GPIO specifications .....	19
Hardware specifications for the programmable variant .....	20
Mechanical drawings .....	20
Pin signals for the surface-mount module .....	22
Pin signals for the through-hole module .....	24
EM357 pin mappings .....	25
Design notes .....	26
Programmable XBee SDK .....	32

## Performance specifications

This table describes the performance specifications for the devices.

Specification	XBee ZigBee S2C	XBee-PRO ZigBee S2C	XBee ZigBee S2D
Indoor/urban range	Up to 60 m (200 ft)	Up to 90 m (300 ft)	Up to 60 m (200 ft)
Outdoor RF line-of-sight range	Up to 1200 m (4000 ft)	Up to 3200 m (2 mi)	Up to 1200 m (4000 ft)
Transmit power output (maximum)	6.3 mW (+8 dBm), boost mode 3.1 mW (+5 dBm), normal mode channel 26 max power is +3 dBm	63 mW (+18 dBm)	6.3 mW (+8 dBm) channel 26 max power is +1 dBm
RF data rate	250,000 b/s		
Receiver sensitivity	-102 dBm, boost mode -100 dBm, normal mode	-101 dBm	-102 dBm, boost mode -100 dBm, normal mode

## Power requirements

The following table describes the power requirements for the devices.

Specification	XBee ZigBee S2C	XBee-PRO ZigBee S2C	XBee ZigBee S2D
Adjustable power	Yes		
Supply voltage	2.1 - 3.6 V 2.2 - 3.6 V for programmable version	2.7 - 3.6 V	2.1 - 3.6 V
Operating current (transmit)	45 mA (+8 dBm, boost mode) 33 mA (+5 dBm, normal mode)	120 mA @ +3.3 V, +18 dBm	45 mA
Operating current (receive)	31 mA (boost mode) 28 mA (normal mode)	31 mA	31 mA
Power-down current	< 1 $\mu$ A @ 25°C		< 3 $\mu$ A @ 25°C

## General specifications

The following table describes the general specifications for the devices.

Specification	XBee ZigBee S2C	XBee-PRO ZigBee S2C	XBee ZigBee S2D
Operating frequency band	ISM 2.4 - 2.5 GHz		
Form factor	through-hole, surface-mount		surface-mount



Specification	XBee ZigBee S2C	XBee-PRO ZigBee S2C	XBee ZigBee S2D
Dimensions	through-hole: 2.438 x 2.761 cm (0.960 x 1.087 in) surface-mount: 2.199 x 3.4 x 0.305 cm (0.866 x 1.33 x 0.120 in)	through-hole: 2.438 x 3.294 cm (0.960 x 1.297 in) surface-mount: 2.199 x 3.4 x 0.305 cm (0.866 x 1.33 x 0.120 in)	surface-mount: 2.199 x 3.4 x 0.305 cm (0.866 x 1.33 x 0.120 in)
Operating temperature	-40 to 85°C (industrial)		
Antenna options	through-hole: PCB antenna, U.FL connector, RPSMA connector, or integrated wire surface-mount: RF pad, PCB antenna, or U.FL connector		

## Networking and security specifications

The following table describes the networking and security specifications for the devices.

Specification	XBee ZigBee S2C	XBee-PRO ZigBee S2C	XBee ZigBee S2D
Supported network topologies	Point-to-point, point-to-multipoint, peer-to-peer, and DigiMesh		
Number of channels	16 Direct sequence channels	15 Direct sequence channels	16 Direct sequence channels
Interface immunity	Direct Sequence Spread Spectrum (DSSS)		
Channels	11 to 26		
Addressing options	PAN ID and addresses, cluster IDs and endpoints (optional)		

## Interface options

The following table describes the interface options for the devices.

Interface options	
UART	1 Mb/s maximum (burst)
SPI	5 Mb/s maximum (burst)

## Agency approvals

This table describes the agency approvals for the devices.

**Note** Legacy XBee-PRO SMT (model: PRO S2C; hardware version 21xx) has different FCC and IC IDs. For more information, see [Certifications](#).

Approval	XBee (surface-mount)	XBee-PRO (surface-mount)	XBee (through-hole)	XBee-PRO (through-hole)	XBee S2D (surface-mount)
United States (FCC Part 15.247)	FCC ID: MCQ-XBS2C	FCC ID: MCQ-XBPS2C (revision K and earlier) FCC ID: MCQ-PS2CSM (revision L and later)	FCC ID: MCQ-S2CTH	FCC ID: MCQ-PS2CTH	FCC ID: MCQ-S2DSM
Industry Canada (IC)	IC: 1846A-XBS2C	IC: 1846A-XBPS2C (revision K and earlier) IC: 1846A-PS2CSM (revision L and later)	IC: 1846A-S2CTH	IC: 1846A-PS2CTH	IC: 1846A-S2DSM
FCC/IC Test Transmit Power Output range	-26 to +8 dBm	-0.7 to +19.4 dBm	-26 to +8 dBm	+1 to +19 dBm	-10 to +8 dBm
Europe (CE)	Yes		Yes		Yes
Australia	RCM	RCM	RCM	RCM	
Japan	R201WW10215369		R210-105563		
Brazil (Res. 506)	ANATEL: 0616-15-1209	ANATEL: 1533-15-1209	ANATEL: 4556-15-1209	ANATEL: 4077-15-1209	
RoHS	Compliant				

## Serial communication specifications

The XBee/XBee-PRO ZigBee RF Module supports both Universal Asynchronous Receiver / Transmitter (UART) and Serial Peripheral Interface (SPI) serial connections.

### UART pin assignments

Specifications	Device pin number	
	XBee (surface-mount)	XBee (through-hole)
DOUT	3	2
DIN / $\overline{\text{CONFIG}}$	4	3
$\overline{\text{CTS}}$ / DIO7	25	12
$\overline{\text{RTS}}$ / DIO6	29	16

For more information on UART operation, see [Operation](#).

## SPI pin assignments

The SC2 (Serial Communication Port 2) of the Ember 357 is connected to the SPI port.

Specifications	Device pin number	
	XBee (surface-mount)	XBee (through-hole)
SPI_SCLK	14	18
SPI_SSEL	15	17
SPI_MOSI	16	11
SPI_MISO	17	4

For more information on SPI operation, see [SPI operation](#).

## GPIO specifications

XBee/XBee-PRO ZigBee RF Modules have 15 General Purpose Input / Output (GPIO) ports available. The exact list depends on the device configuration as some GPIO pads are used for purposes such as serial communication.

See [Enable GPIO 1 and 2](#) for more information on configuring and using GPIO ports.

GPIO electrical specification	Value
Voltage - supply	2.1 - 3.6 V
Low Schmitt switching threshold	0.42 - 0.5 x VCC
High Schmitt switching threshold	0.62 - 0.8 x VCC
Input current for logic 0	-0.5 $\mu$ A
Input current for logic 1	0.5 $\mu$ A
Input pull-up resistor value	29 k $\Omega$
Input pull-down resistor value	29 k $\Omega$
Output voltage for logic 0	0.18 x VCC (maximum)
Output voltage for logic 1	0.82 x VCC (minimum)
Output source/sink current for pad numbers 3, 4, 5, 10, 12, 14, 15, 16, 17, 25, 26, 28, 29, 30, and 32 on the SMT modules	4 mA
Output source/sink current for pin numbers 2, 3, 4, 9, 12, 13, 15, 16, 17, and 19 on the TH modules	4 mA

GPIO electrical specification	Value
Output source/sink current for pad numbers 7, 8, 24, 31, and 33 on the SMT modules	8 mA
Output source/sink current for pin numbers 6, 7, 11, 18, and 20 on the TH modules	8 mA
Total output current (for GPIO pads)	40 mA

## Hardware specifications for the programmable variant

If the module has the programmable secondary processor, add the following table values to the specifications listed. For example, if the secondary processor is running at 20 MHz and the primary processor is in receive mode then the new current value will be  $I_{total} = I_{r2} + I_{rx} = 14\text{ mA} + 9\text{ mA} = 23\text{ mA}$ , where  $I_{r2}$  is the runtime current of the secondary processor and  $I_{rx}$  is the receive current of the primary.

Optional secondary processor specification	Add to RX, TX, and sleep currents specifications depending on mode of operation
Runtime current for 32 k running at 20 MHz	+14 mA
Runtime current for 32 k running at 1 MHz	+1 mA
Sleep current	+0.5 $\mu$ A typical
For additional specifications see NXP Datasheet and Manual	MC9S08QE32
Minimum Reset low pulse time for EM357	+26 $\mu$ S
V <sub>REF</sub> Range	1.8 VDC to V <sub>CC</sub>

## Mechanical drawings

The following mechanical drawings of the XBee/XBee-PRO ZigBee RF Modules show all dimensions in inches. The first drawing shows the XBee/XBee -PRO surface-mount model (antenna options not shown).

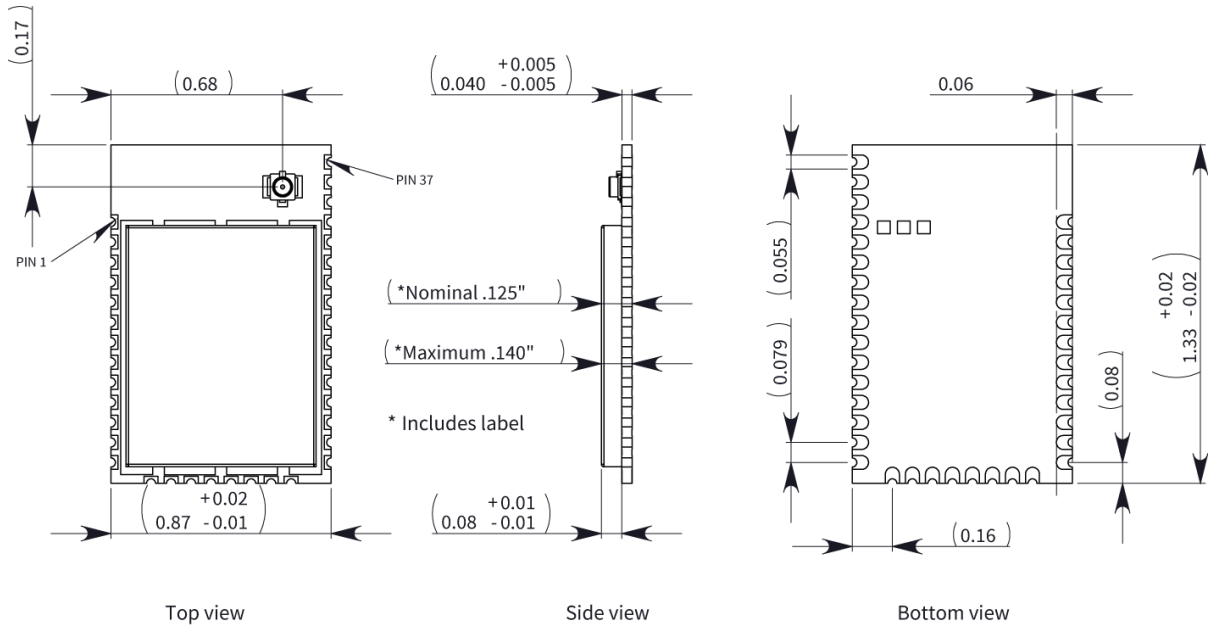

The drawings below show the XBee through-hole model

### RPSMA

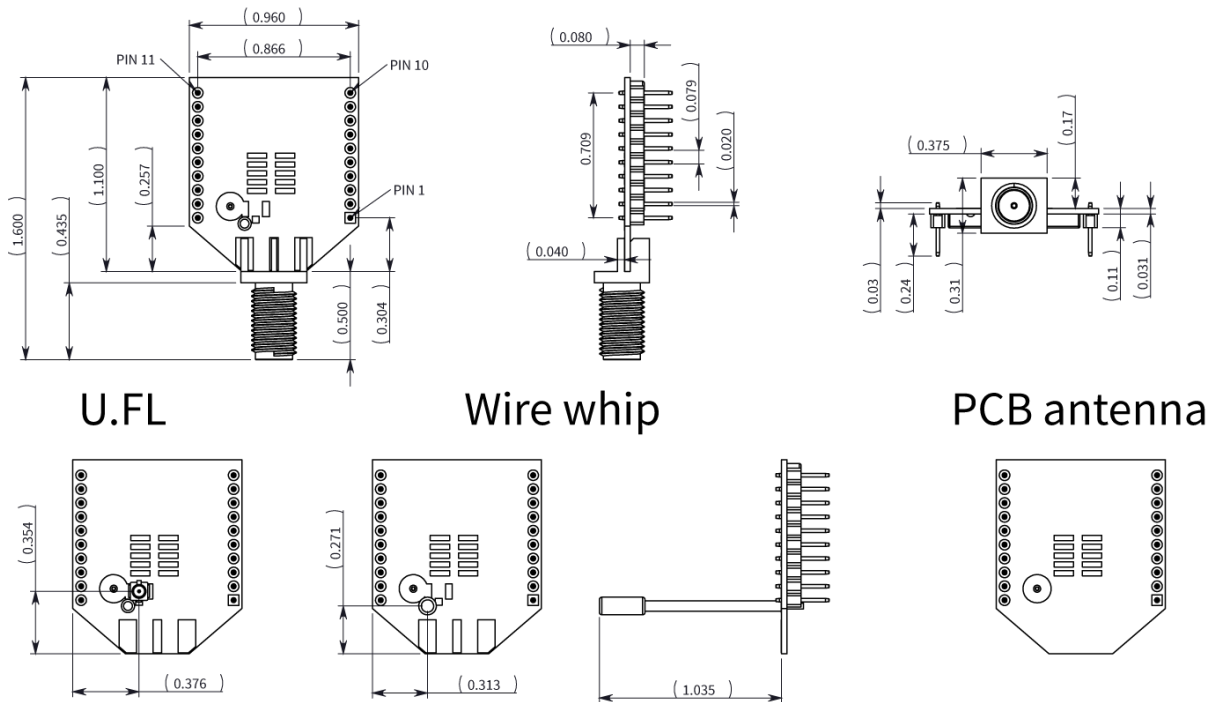

The drawings below show the XBee-PRO through-hole model.

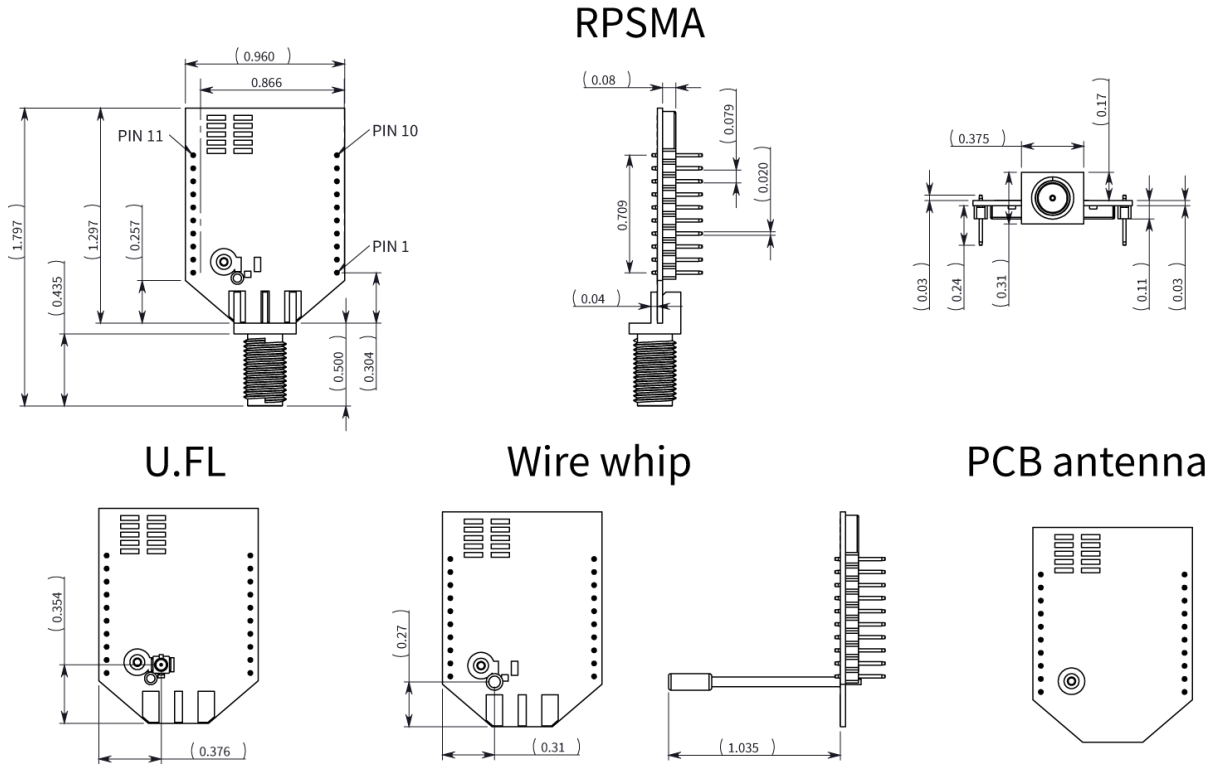

## Pin signals for the surface-mount module

The following drawing shows the surface-mount (SMT) pin locations.

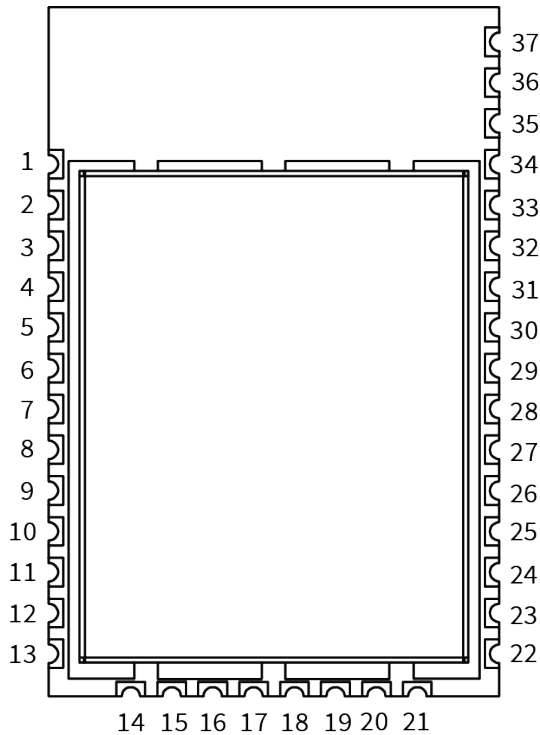

The following table shows the pin signals and their descriptions for the surface-mount device.

Pin#	Name	Direction	Default state	Description
1	GND	-	-	Ground
2	VCC	-	-	Power supply
3	DOUT /DIO13	Both	Output	UART data out /GPIO
4	DIN / CONFIG /DIO14	Both	Input	UART data in /GPIO
5	DIO12	Both		GPIO
6	$\overline{\text{RESET}}$	Input		Device reset
7	RSSI PWM/DIO10	Both	Output	RX signal strength Indicator /GPIO
8	PWM1/DIO11	Both	Disabled	Pulse width modulator/GPIO
9	[reserved]	-	Disabled	Do not connect
10	$\overline{\text{DTR/SLEEP\_RQ}}$ /DIO8	Both	Input	Pin sleep control Line/GPIO
11	GND	-	-	Ground
12	$\overline{\text{SPI\_ATTN/BOOTMODE}}$ /DIO19	Output	Output	Serial peripheral interface attention Do not tie low on reset
13	GND	-	-	Ground
14	SPI_CLK /DIO18	Input	Input	Serial peripheral interface clock/GPIO
15	$\overline{\text{SPI\_SSEL}}$ /DIO17	Input	Input	Serial peripheral interface not select/GPIO
16	SPI_MOSI/DIO16	Input	Input	Serial peripheral interface data in/GPIO
17	SPI_MISO/DIO15	Output	Output	Serial peripheral interface data out/GPIO
18	[reserved]*	-	Disabled	Do not connect
19	[reserved]*	-	Disabled	Do not connect
20	[reserved]*	-	Disabled	Do not connect
21	[reserved]*	-	Disabled	Do not connect
22	GND	-	-	Ground
23	[reserved]	-	Disabled	Do not connect

Pin#	Name	Direction	Default state	Description
24	DIO4	Both	Disabled	GPIO
25	$\overline{\text{CTS}}$ /DIO7	Both	Output	Clear to send flow control/GPIO
26	ON/ $\overline{\text{SLEEP}}$ /DIO9	Both	Output	Device status indicator/GPIO
27	VREF	Input	-	Not used for EM357. Used for programmable secondary processor. For compatibility with other XBee devices, we recommend connecting this pin to the voltage reference if analog sampling is desired. Otherwise, connect to GND.
28	ASSOCIATE/DIO5	Both	Output	Associate Indicator/GPIO
29	$\overline{\text{RTS}}$ /DIO6	Both	Input	Request to send flow control /GPIO
30	AD3/DIO3	Both	Disabled	Analog input/GPIO
31	AD2/DIO2	Both	Disabled	Analog input/GPIO
32	AD1/DIO1	Both	Disabled	Analog input/GPIO
33	AD0 /DIO0	Both	Input	Analog input / GPIO / Commissioning button
34	[reserved]	-	Disabled	Do not connect
35	GND	-	-	Ground
36	RF	Both	-	RF I/O for RF pad variant
37	[reserved]	-	Disabled	Do not connect

Signal direction is specified with respect to the device.  
 See [Design notes](#) for details on pin connections.  
 \* Refer to [Writing custom firmware](#) for instructions on using these pins if JTAG functions are needed.

## Pin signals for the through-hole module

The following table shows the pin signals and their descriptions for the through-hole module.

Pin #	Name	Direction	Default state	Description
1	VCC	-	-	Power supply
2	DOUT/DIO13	Both	Output	UART data out



Pin #	Name	Direction	Default state	Description
3	DIN/ $\overline{\text{CONFIG}}$ / DIO14	Both	Input	UART data in
4	DIO12/SPI_MISO	Both	Disabled	GPIO/SPI slave out
5	$\overline{\text{RESET}}$	Input	Input	Module reset
6	RSSI PWM/PWMO DIO10	Both	Output	RX signal strength indicator/GPIO
7	PWM1/DIO11	Both	Disabled	GPIO
8	[reserved]	-	-	Do not connect
9	$\overline{\text{DTR}}$ /SLEEP_RQ/ DIO8	Both	Input	Pin sleep control line/GPIO
10	GND	-	-	Ground
11	SPI_MOSI/DIO4	Both	Disabled	GPIO/SPI slave in
12	$\overline{\text{CTS}}$ /DIO7	Both	Output	Clear-to-send flow control/GPIO
13	ON_ $\overline{\text{SLEEP}}$ /DIO9	Both	Output	Device status indicator/GPIO
14	VREF	-	-	Not connected
15	ASSOCIATE/DIO5	Both	Output	Associate indicator/GPIO
16	$\overline{\text{RTS}}$ /DIO6	Both	Input	Request to send flow control/ GPIO
17	AD3/DIO3/SPI_ $\overline{\text{SSEL}}$	Both	Disabled	Analog input/GPIO/SPI slave select
18	AD2 / DIO2/SPI_CLK	Both	Disabled	Analog input/GPIO/SPI clock
19	AD1/DIO1/SPI_ $\overline{\text{ATTN}}$	Both	Disabled	Analog input/GPIO/SPI attention
20	AD0/DIO0/CB	Both	Disabled	Analog input/GPIO/ Commissioning button

## EM357 pin mappings

The following table shows how the EM357 pins are used on the device.

**Note** Some lines may not go to the external device pins in the programmable secondary processor version.

EM357 pin#	EM357 pin name	XBee (SMT) pad#	XBee (TH) pin #	Other usage
12	RST	6	5	Programming
18	PA7	8	7	

EM357 pin#	EM357 pin name	XBee (SMT) pad#	XBee (TH) pin #	Other usage
19	PB3	29	16	Used for UART
20	PB4	25	12	Used for UART
21	PA0/ SC2MOSI	16	11	Used for SPI
22	PA SC2MISO	17	4	Used for SPI
24	PA2/SC2SCLK	14	18	Used for SPI
25	PA3/SC2SSEL	15	17	Used for SPI
26	PA4/PTI_EN	32	19	OTA packet tracing
27	PA5/PTI_DATA/BOOTMODE	12	NA	OTA packet tracing, force embedded serial bootloader, and SPI attention line
29	PA6	7	6	
30	PB1/SC1TXD	3	2	Used for UART
31	PB2/SC1RXD	4	3	Used for UART
33	PC2/JTDO/SWO	26	13	JTAG (see <a href="#">Writing custom firmware</a> )
34	PC3/JTDI	28	15	JTAG (see <a href="#">Writing custom firmware</a> )
35	PC4/JTMS/SWDIO	5	4	JTAG (see <a href="#">Writing custom firmware</a> )
36	PB0	10	9	
38	PC1/ADC3	30	17	
41	PB7/ADC2	31	18	
42	PB6/ADC1	33	20	
43	PB5/ADC0			Temperature sensor on PRO version

## Design notes

The XBee modules do not require any external circuitry or specific connections for proper operation. However, there are some general design guidelines that we recommend to build and troubleshoot a robust design.

### Power supply design

A poor power supply can lead to poor radio performance, especially if you do not keep the supply voltage within tolerance or if it is excessively noisy. To help reduce noise, place a 1.0  $\mu$ F and 8.2 pF capacitor as near as possible to pad 2/SMT or pin 1/TH on the PCB. If you are using a switching regulator for the power supply, switch the frequencies above 500 kHz. Limit the power supply ripple to a maximum 50 mV peak to peak.

For designs using the programmable modules, we recommend an additional 10 $\mu$ F decoupling cap near (pad 2/SMT, pin 1/TH) of the module. The nearest proximity to (pad 2/SMT, pin 1/TH) of the three caps should be in the following order:

1. 8.2 pF
2. 1  $\mu$ F
3. 10  $\mu$ F

## Board layout

We design XBee modules to be self-sufficient and have minimal sensitivity to nearby processors, crystals or other printed circuit board (PCB) components. Keep power and ground traces thicker than signal traces and make sure that they are able to comfortably support the maximum current specifications. There are no other special PCB design considerations to integrate XBee modules, with the exception of antennas.

## Antenna performance

Antenna location is important for optimal performance. The following suggestions help you achieve optimal antenna performance. Point the antenna up vertically (upright). Antennas radiate and receive the best signal perpendicular to the direction they point, so a vertical antenna's omnidirectional radiation pattern is strongest across the horizon.

Position the antennas away from metal objects whenever possible. Metal objects between the transmitter and receiver can block the radiation path or reduce the transmission distance. Objects that are often overlooked include:

- Metal poles
- Metal studs
- Structure beams
- Concrete, which is usually reinforced with metal rods

If you place the device inside a metal enclosure, use an external antenna. Common objects that have metal enclosures include:

- Vehicles
- Elevators
- Ventilation ducts
- Refrigerators
- Microwave ovens
- Batteries
- Tall electrolytic capacitors

Use the following additional guidelines for optimal antenna performance:

- Do not place XBee modules with the chip or integrated PCB antenna inside a metal enclosure.
- Do not place any ground planes or metal objects above or below the antenna.
- For the best results, mount the device at the edge of the host PCB. Ensure that the ground, power, and signal planes are vacant immediately below the antenna section.
- For more information, see [Design notes for PCB antenna devices](#).

## Recommended pin connections

The only required pin connections for two-way communication are VCC, GND, DOUT and DIN. To support serial firmware updates, you must connect VCC, GND, DOUT, DIN, RTS, and DTR.

For applications that need to ensure the lowest sleep current, never leave unconnected inputs floating. Use internal or external pull-up or pull-down resistors, or set the unused I/O lines to outputs.

For analog sampling, attach the VREF pin (pin 14) to a voltage reference.

## Design notes for PCB antenna devices

Position PCB Antenna devices so there are no ground planes or metal objects above or below the antenna. For best results, do not place the device in a metal enclosure, as this may greatly reduce the range. Place the device at the edge of the PCB on which it is mounted. Make sure the ground, power and signal planes are vacant immediately below the antenna section.

The following drawings illustrate important recommendations when you are designing with PCB antenna devices. For optimal performance, do not mount the device on the RF pad footprint described in the next section, because the footprint requires a ground plane within the PCB Antenna keep out area.

## Surface-mount keepout area

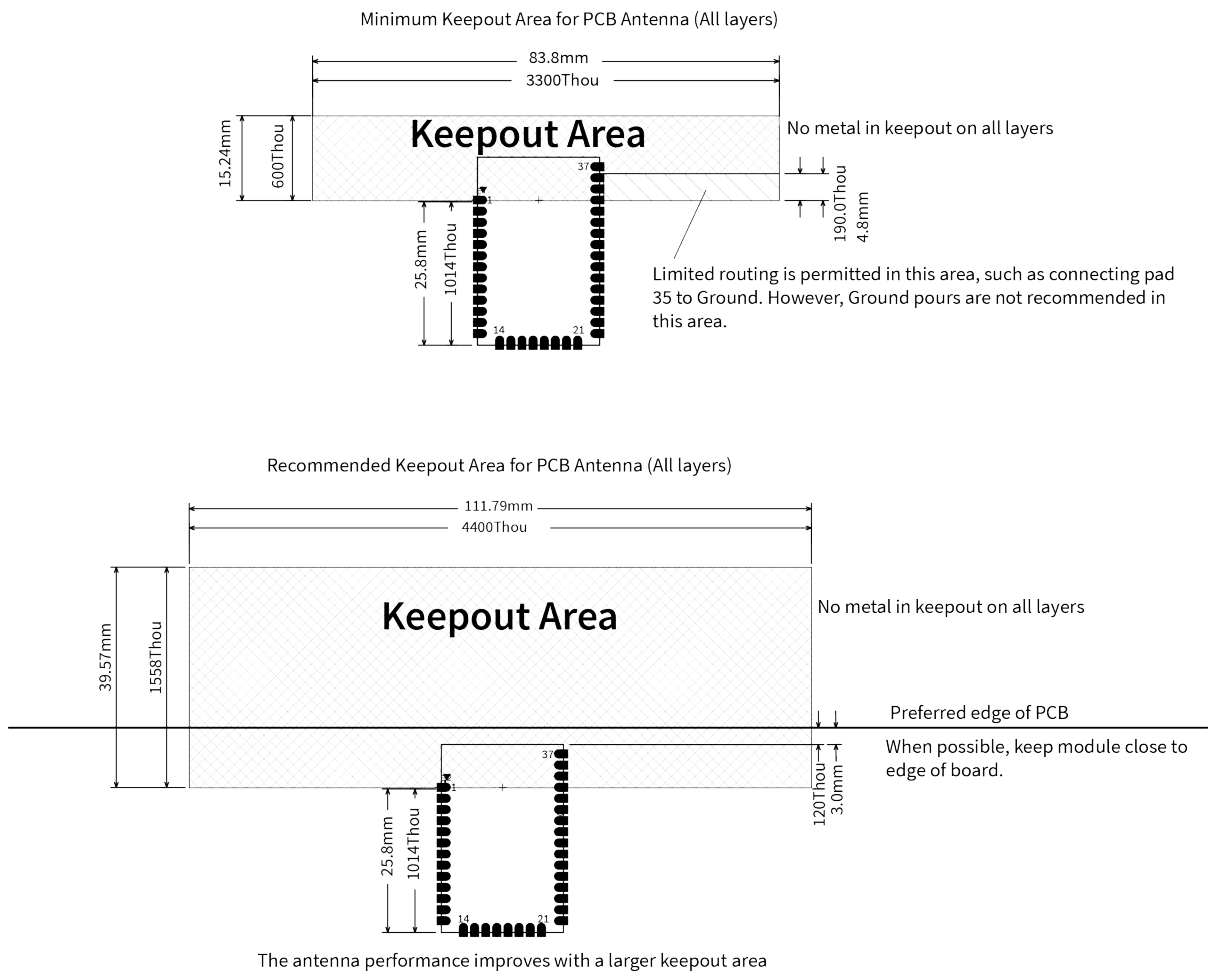

**Notes**

1. We recommend non-metal enclosures. For metal enclosures, use an external antenna.
2. Keep metal chassis or mounting structures in the keepout area at least 2.54 cm (1 in) from the antenna.
3. Maximize the distance between the antenna and metal objects that might be mounted in the keepout area.
4. These keepout area guidelines do not apply for wire whip antennas or external RF connectors. Wire whip antennas radiate best over the center of a ground plane.

**Through-hole keepout area**

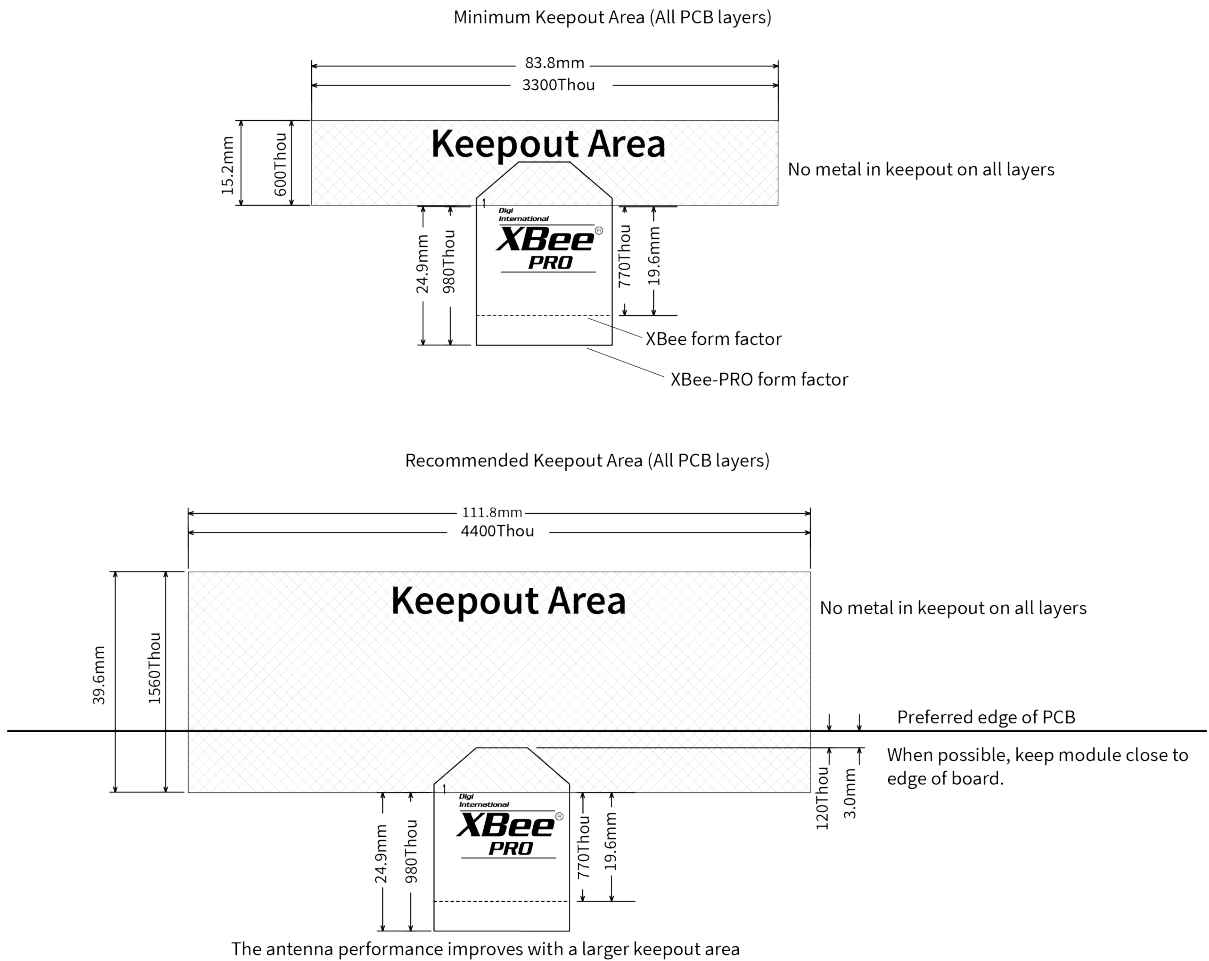

**Notes**

1. We recommend non-metal enclosures. For metal enclosures, use an external antenna.
2. Keep metal chassis or mounting structures in the keepout area at least 2.54 cm (1 in) from the antenna.

3. Maximize the distance between the antenna and metal objects that might be mounted in the keepout area.
4. These keepout area guidelines do not apply for wire whip antennas or external RF connectors. Wire whip antennas radiate best over the center of a ground plane.

## Design notes for SMT RF pad devices

The RF pad is a soldered antenna connection. The RF signal travels from pin 36 on the device to the antenna through an RF trace transmission line on the PCB. Any additional components between the device and antenna violates modular certification. The controlled impedance for the RF trace is 50 ohms. We recommend using a microstrip trace, although you can also use a coplanar waveguide if you need more isolation. Microstrip generally requires less area on the PCB than coplanar waveguide. We do not recommend stripline because sending the signal to different PCB layers can introduce matching and performance problems.

Following good design practices is essential when implementing the RF trace on a PCB. Consider the following points:

- Minimize the length of the trace by placing the RPSMA jack close to the device.
- Connect all of the grounds on the jack and the device to the ground planes directly or through closely placed vias.
- Space any ground fill on the top layer at least twice the distance  $d$  (in this case, at least 0.050") from the microstrip to minimize their interaction.

Additional considerations:

- The top two layers of the PCB have a controlled thickness dielectric material in between.
- The second layer has a ground plane which runs underneath the entire RF pad area. This ground plane is a distance  $d$ , the thickness of the dielectric, below the top layer.
- The top layer has an RF trace running from pin 36 of the device to the RF pin of the RPSMA connector.
- The RF trace width determines the impedance of the transmission line with relation to the ground plane. Many online tools can estimate this value, although you should consult the PCB manufacturer for the exact width.
- The width in this example is approximately 0.045" for a 50 ohm trace, assuming  $d=0.025$ ", and that the dielectric has a relative permittivity of 4.4. This trace width is a good fit with the device footprint's 0.060" pad width.

---

**Note** We do not recommend using a trace wider than the pad width, and using a very narrow trace (under 0.010") can cause unwanted RF loss.

---

Implementing these design suggestions helps ensure that the RF pad device performs to its specifications.

The following figures show a layout example of a host PCB that connects an RF pad device to a right angle, through-hole RPSMA jack.

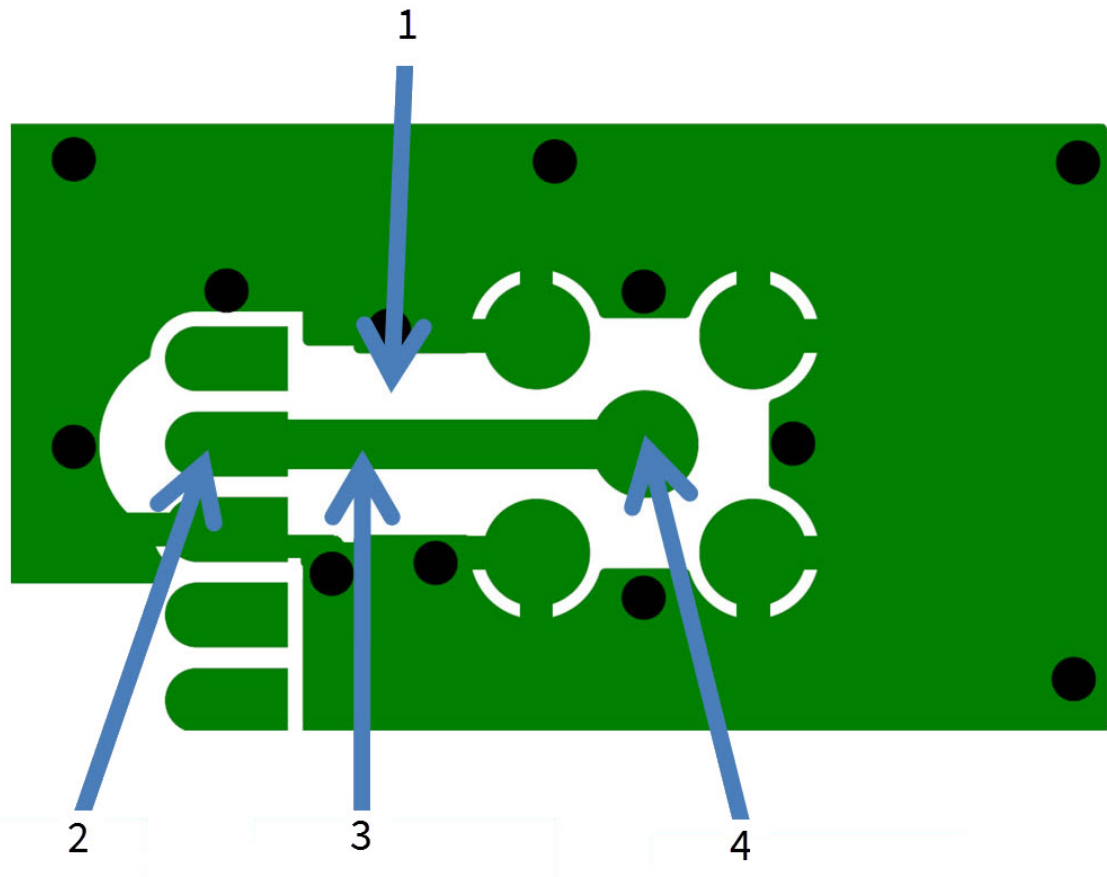

Number	Description
1	Maintain a distance of at least 2 d between microstrip and ground fill
2	Device pin 36
3	50 Ω microstrip trace
4	RF connection of RPSMA jack

The following illustration shows PCB layer 2 of an example RF layout.

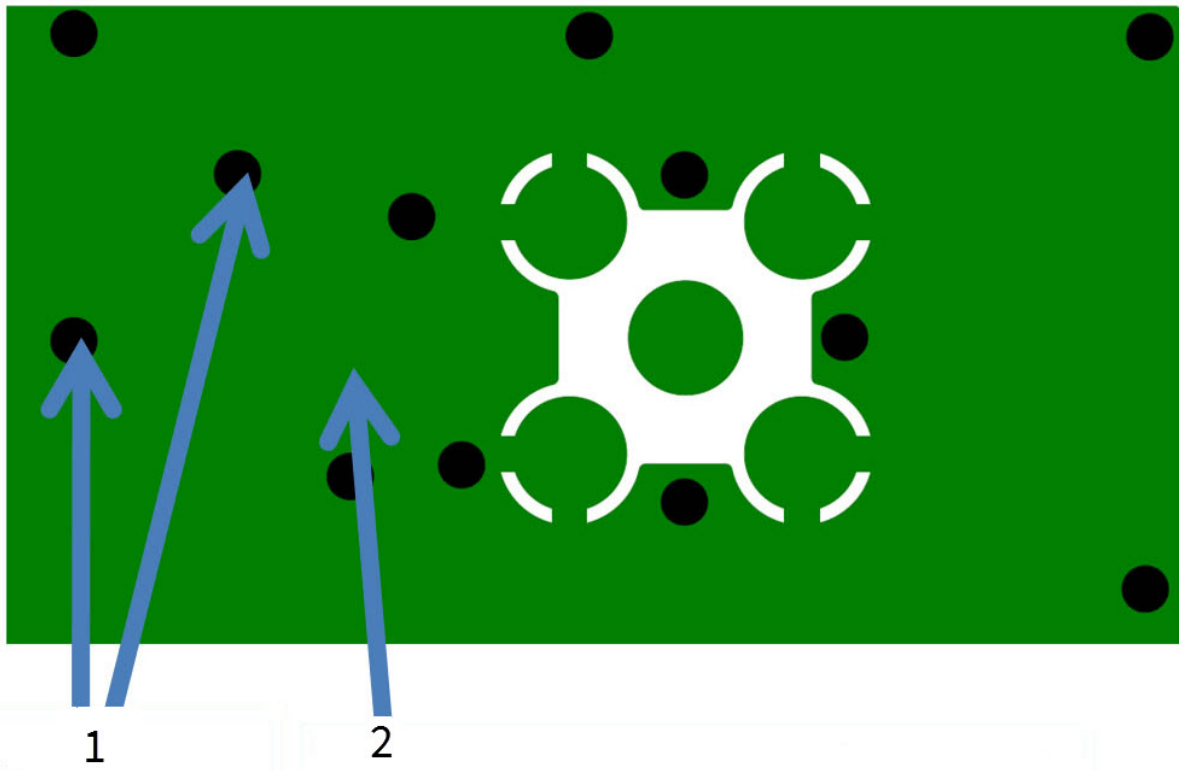

Number	Description
1	Use multiple vias to help eliminate ground variations
2	Put a solid ground plane under RF trace to achieve the desired impedance

### Module operation for the programmable variant

The modules with the programmable option have a secondary processor with 32k of flash and 2k of RAM. This allows module integrators to put custom code on the XBee module to fit their own unique needs. The secondary processor intercepts the DIN, DOUT, RTS, CTS, and RESET lines to allow it to be in control of the data transmitted and received. All other lines are in parallel and can be controlled by either the EM357 or the MC9S08QE micro. See the following block diagram for details. The Programmable XBee SDK native APIs automatically handle pin use.

For the secondary processor to sample with ADCs, the XBee VREF pin (27/SMT, 14/TH) must be connected to a reference voltage.

Digi provides a bootloader that can take care of programming the processor over-the-air or through the serial interface. This means that over-the-air updates can be supported through an XMODEM protocol. The processor can also be programmed and debugged through a one wire interface BKGD (Pin 9/SMT, Pin 8/TH).

### Programmable XBee SDK

The XBee Programmable module is equipped with a NXP MC9S08QE32 application processor. This application processor comes with a supplied bootloader. To interface your application code running on



this processor to the XBee Programmable module's supplied bootloader, use the Programmable XBee SDK.

To use the SDK, you must also download CodeWarrior. The download links are:

- CodeWarrior IDE: [http://ftp1.digi.com/support/sampleapplications/40003004\\_B.exe](http://ftp1.digi.com/support/sampleapplications/40003004_B.exe)
- Programmable XBee SDK: [http://ftp1.digi.com/support/sampleapplications/40003003\\_D.exe](http://ftp1.digi.com/support/sampleapplications/40003003_D.exe)

If these revisions change, search for the part number on Digi's website. For example, search for "40003003".

Install the IDE first, and then install the SDK.

The documentation for the Programmable XBee SDK is built into the SDK, so the Getting Started guide appears when you open CodeWarrior.

## Programmable connections

The following figure shows the programmable connections for the SMT.

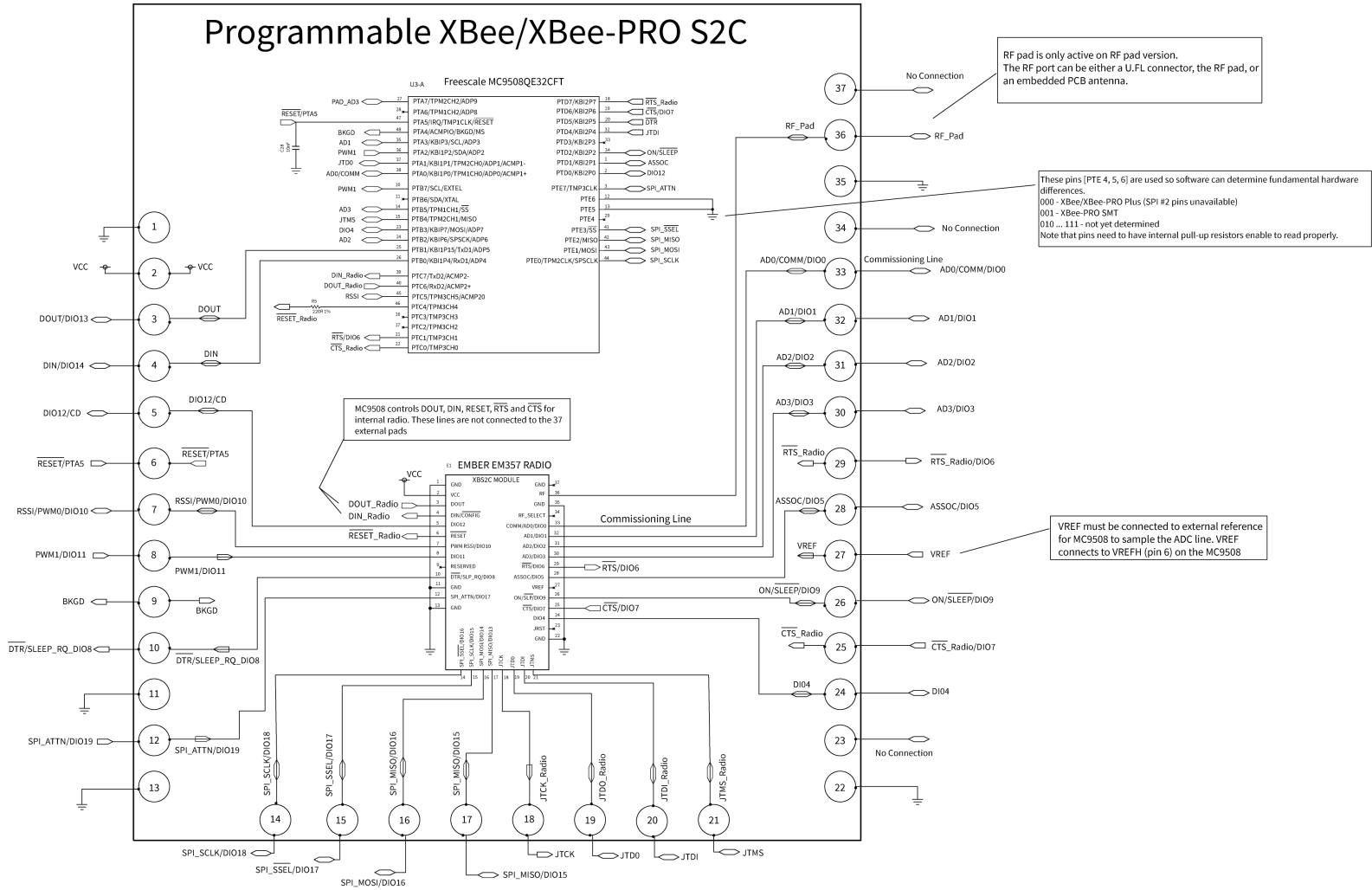

The following illustration shows the programmable connections for the TH Module.

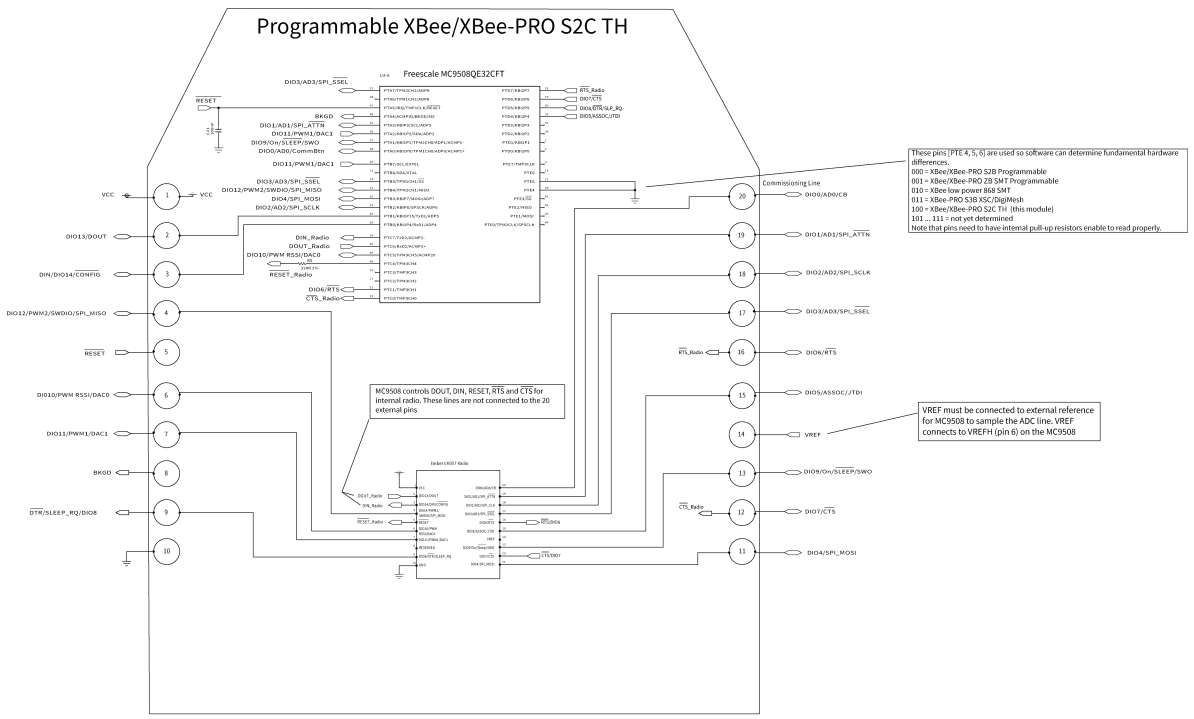

## Operation

---

Serial interface .....	37
UART data flow .....	37
SPI communications .....	38
Serial buffers .....	39
UART flow control .....	40
Break control .....	41
Serial interface protocols .....	41
Modes of operation .....	44

## Serial interface

The XBee/XBee-PRO ZigBee RF Module interface to a host device through a serial port. The device can communicate with any logic and voltage compatible UART, through a level translator to any serial device (for example, through a RS-232 or USB interface board), or through a [SPI communications](#).

**Note** Two Wire serial Interface (TWI) is also available, but not supported by Digi. For information on the TWI, see the [EM357 pin mappings](#).

## UART data flow

Devices that have a UART interface connect directly to the pins of the XBee/XBee-PRO ZigBee RF Module as shown in the following figure. The figure shows system data flow in a UART-interfaced environment. Low-asserted signals have a horizontal line over the signal name.

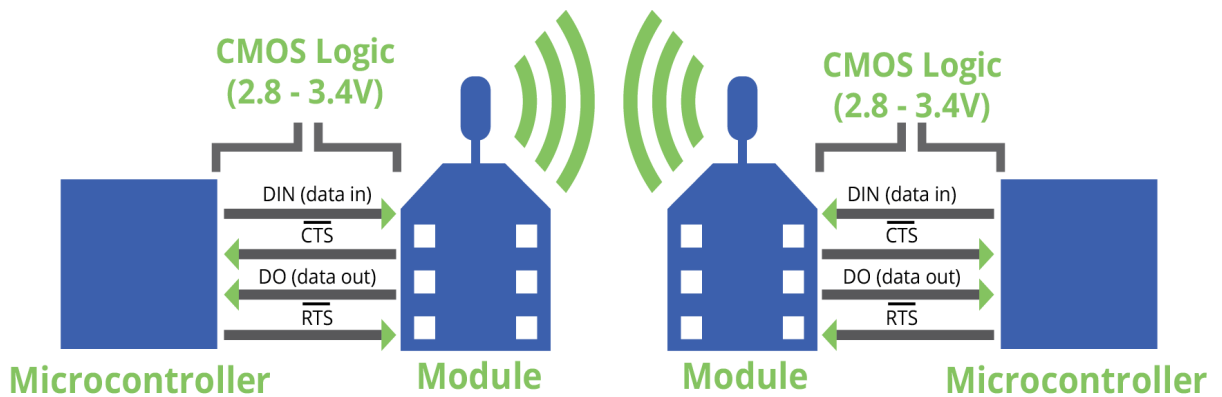

## Serial data

A device sends data to the device's UART through pin 4 (DIN) as an asynchronous serial signal. When the device is not transmitting data, the signal idles high.

For serial communication to occur, you must configure the UART of both devices (the microcontroller and the RF module) with compatible settings for the baud rate, parity, start bits, stop bits, and data bits.

Each data byte consists of a start bit (low), 8 data bits (least significant bit first) and a stop bit (high). The following diagram illustrates the serial bit pattern of data passing through the device. The diagram shows UART data packet 0x1F (decimal number 31) as transmitted through the device.

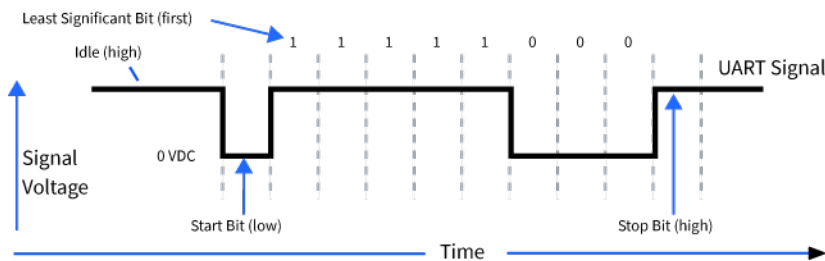

You can configure the UART baud rate, parity, and stop bits settings on the device with the **BD**, **NB**, and **SB** commands respectively. For more information, see [Serial interfacing commands](#).

## SPI communications

The XBee/XBee-PRO ZigBee RF Module supports SPI communications in slave mode. Slave mode receives the clock signal and data from the master and returns data to the master. The following table shows the signals that the SPI port uses on the device.

Signal	Function
SPI_MOSI (Master Out, Slave In)	Inputs serial data from the master
SPI_MISO (Master In, Slave Out)	Outputs serial data to the master
SPI_SCLK (Serial Clock)	Clocks data transfers on MOSI and MISO
SPI_SSEL (Slave Select)	Enables serial communication with the slave

The preceding four pins are standard for SPI. This module also supports an additional pin, which may be configured to alert the SPI master when it has data to send. This pin is called SPI\_ATTN. If the master monitors this pin (through polling or interrupts), it can know when it needs to receive data from the module. SPI\_ATTN asserts whenever it has data to send and it remains asserted until all available data has been shifted out to the SPI master.

In this mode:

- Data/clock rates of up to 5 Mb/s are possible.
- Data is most significant bit (MSB) first.
- Frame Format mode 0 is used. This means CPOL= 0 (idle clock is low) and CPHA = 0 (data is sampled on the clock's leading edge). The following diagram illustrates Mode 0.

The following diagram shows the frame format for SPI communications.

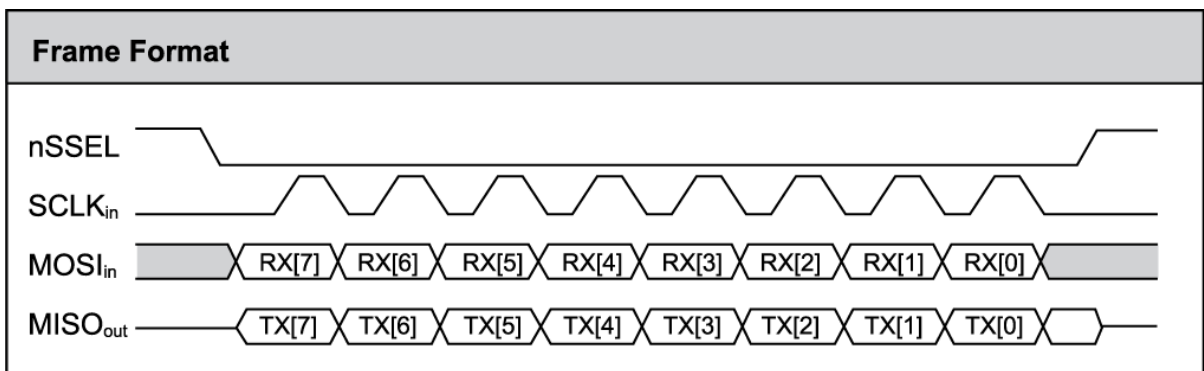

## SPI operation

When the master asserts the slave select (SPI\_SSEL), the device drives SPI transmit data to the output pin (SPI\_MISO), and receives SPI data from the input pin SPI\_MOSI. The SPI\_SSEL pin must be asserted to enable the transmit serializer to drive data to the output signal SPI\_MISO. A rising edge on SPI\_SSEL resets the SPI slave shift registers.

If the SPI\_SCLK is present, the SPI\_MISO line is always driven whether with or without the SPI\_SSEL line driven. This is a known issue with the Ember EM357 chip, and makes additional hardware necessary if multiple slaves are using the same bus as the device.

If the input buffer is empty, the SPI serializer transmits a busy token (0xFF). Otherwise, all transactions on the SPI port use API operation. See [API Operation](#) for more information.

The SPI slave controller must guarantee that there is time to move new transmit data from the transmit buffer into the hardware serializer. To provide sufficient time, the SPI slave controller inserts a byte of padding at the start of every new string of transmit data. Whenever the transmit buffer is empty and the device places data into the transmit buffer, the SPI hardware inserts a byte of padding onto the front of the transmission as if this byte were placed there by software.

### Serial port selection

In the default configuration both the UART and SPI ports are configured for serial port operation. In this case, serial data goes out the UART until the device asserts the SPI\_SSEL signal. Thereafter all serial communications operate only on the SPI interface until a reset occurs.

If you enable only the UART, the device uses only the UART, and it ignores the SPI\_SSEL.

If you enable only the SPI, the device uses only the SPI, and it ignores UART communications. If you hold DOUT low during boot, then the device only uses the SPI.

Once SPI is in use, do not attempt to apply changes (**AC**) which change the UART or SPI settings. Instead, use the following:

- 0x09 frames to reconfigure UART/SPI/other settings
- **WR** to save the settings
- **FR** to reset the XBee and use the new configuration settings

If neither serial port is enabled, then UART remains enabled, the device uses only the UART, and it ignores SPI\_SSEL.

### Serial buffers

The XBee/XBee-PRO ZigBee RF Module maintain buffers to collect serial and RF data that it receives. The serial receive buffer collects incoming serial characters and holds them until the device can process them. The serial transmit buffer collects the data it receives via the RF link until it transmits that data out the serial port. The following figure shows the process of device buffers collecting received serial data.

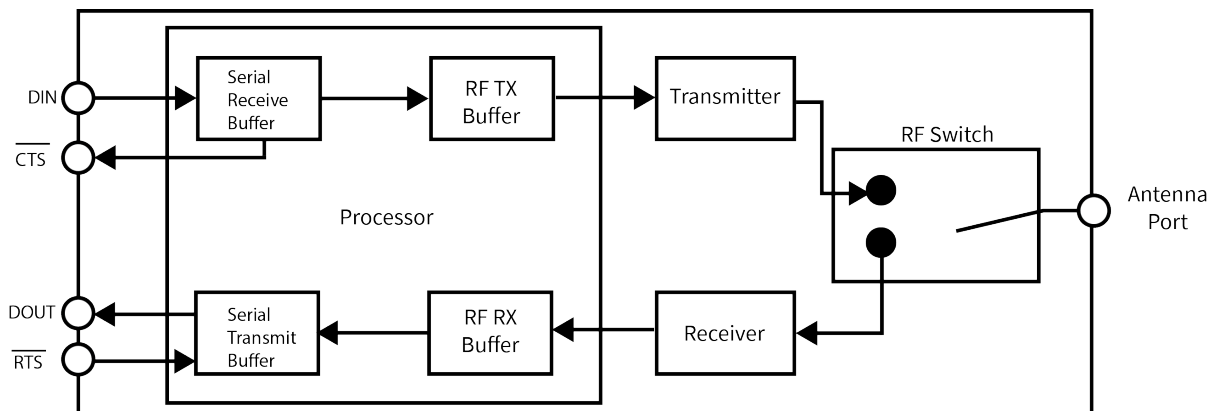

## Serial receive buffer

When serial data enters the RF module through the serial port, the device stores the data in the serial receive buffer until it can be processed. Under certain conditions, the device may receive data when the serial receive buffer is already full. In that case, the device discards the data.

The serial receive buffer becomes full when data is streaming into the serial port faster than it can be processed and sent over the air (OTA). While the speed of receiving the data on the serial port can be much faster than the speed of transmitting to data for a short period, sustained operation in that mode causes the device to drop data due to running out of places to put the data. Some things that may delay over the air transmissions are address discovery, route discovery, and retransmissions. Processing received RF data can also take away time and resources for processing incoming serial data.

If the UART is the serial port and you enable the  $\overline{\text{CTS}}$  flow control, the device alerts the external data source when the receive buffer is almost full. The host delays sending data to the device until the module asserts  $\overline{\text{CTS}}$  again, allowing more data to come in.

If the SPI is the serial port, no hardware flow control is available. It is your responsibility to ensure that the receive buffer does not overflow. One reliable strategy is to wait for a TX\_STATUS response after each frame sent to ensure that the device has had time to process it.

## Serial transmit buffer

When the device receives RF data, it moves the data into the serial transmit buffer and sends it out the UART or SPI port. If the serial transmit buffer becomes full and the system buffers are also full, then it drops the entire RF data packet. Whenever the device receives data faster than it can process and transmit the data out the serial port, there is a potential of dropping data.

Cases in which the serial transmit buffer may become full, resulting in dropped RF packets:

1. If the RF data rate is set higher than the interface data rate of the device, the device may receive data faster than it can send the data to the host. Even occasional transmissions from a large number of devices can quickly accumulate and overflow the transmit buffer.
2. If the host does not allow the device to transmit data out from the serial transmit buffer due to being held off by hardware flow control.

## UART flow control

You can use the  $\overline{\text{RTS}}$  and  $\overline{\text{CTS}}$  pins to provide  $\overline{\text{RTS}}$  and/or  $\overline{\text{CTS}}$  flow control.  $\overline{\text{CTS}}$  flow control provides an indication to the host to stop sending serial data to the device.  $\overline{\text{RTS}}$  flow control allows the host to signal the device to not send data in the serial transmit buffer out the UART. To enable  $\overline{\text{RTS/CTS}}$  flow control, use the **D6** and **D7** commands.

---

**Note** Serial port flow control is not possible when using the SPI port.

---

### $\overline{\text{CTS}}$ flow control

If you enable  $\overline{\text{CTS}}$  flow control (**D7** command), when the serial receive buffer is 17 bytes away from being full, the device de-asserts  $\overline{\text{CTS}}$  (sets it high) to signal to the host device to stop sending serial data. The device reasserts  $\overline{\text{CTS}}$  after the serial receive buffer has 34 bytes of space. See [FT \(Flow Control Threshold\)](#) for the buffer size.



## RTS flow control

If you send the **D6** command to enable  $\overline{\text{RTS}}$  flow control, the device does not send data in the serial transmit buffer out the DOUT pin as long as  $\overline{\text{RTS}}$  is de-asserted (set high). Do not de-assert  $\overline{\text{RTS}}$  for long periods of time or the serial transmit buffer will fill. If the device receives an RF data packet and the serial transmit buffer does not have enough space for all of the data bytes, it discards the entire RF data packet.

If the device sends data out the UART when  $\overline{\text{RTS}}$  is de-asserted (set high) the device could send up to five characters out the UART port after  $\overline{\text{RTS}}$  is de-asserted.

## Break control

If break is enabled for over five seconds, the device resets. Then it will boot with default baud settings into command mode.

This break function will be disabled if either **P3** or **P4** are not enabled.

## Serial interface protocols

The XBee devices support both transparent and Application Programming Interface (API) serial interfaces.

### Transparent operation

When operating in transparent mode, the devices act as a serial line replacement. The device queues up all UART or SPI data received through the DIN or MOSI pin for RF transmission. When RF data is received, the device sends the data out through the serial port. Use the AT command mode interface to configure the device configuration parameters.

---

**Note** Transparent operation is not provided when using the SPI.

---

The device buffers data in the serial receive buffer and packetizes and transmits the data when it receives the following:

- No serial characters for the amount of time determined by the RO (Packetization Timeout) parameter. If **RO** = 0, packetization begins when the device received a character.
- Command Mode Sequence (**GT** + **CC** + **GT**). Any character buffered in the serial receive buffer before the device transmits the sequence.
- Maximum number of characters that fit in an RF packet.

### API operation

API operation is an alternative to transparent operation. The frame-based API extends the level to which a host application can interact with the networking capabilities of the device. When in API mode, the device contains all data entering and leaving in frames that define operations or events within the device.

Transmit Data Frames (received through the serial port) include:

- RF Transmit Data Frame
- Command Frame (equivalent to AT commands)

Receive Data Frames (sent out the serial port) include:

- RF-received data frame
- Command response
- Event notifications, such as reset, associate, disassociate

The API provides alternative means of configuring devices and routing data at the host application layer. A host application can send data frames to the device that contain address and payload information instead of using command mode to modify addresses. The device sends data frames to the application containing status packets, as well as source and payload information from received data packets.

The API operation option facilitates many operations such as the following examples:

- Transmitting data to multiple destinations without entering Command Mode
- Receive success/failure status of each transmitted RF packet
- Identify the source address of each received packet

### Compare Transparent and API operation

The following table compares the advantages of Transparent and API modes of operation:

Transparent operation	
Simple interface	The device transmits all received serial data unless it is in Command mode.
Easy to support	It is easier for an application to support transparent operation and Command mode

API operation	
Easy to manage data transmissions to multiple destinations	Transmitting RF data to multiple remotes only requires changing the address in the API frame. This process is much faster than in transparent operation where the application must enter Command mode, change the address, exit command mode, and then transmit data. Each API transmission can return a transmit status frame indicating the success or reason for failure.
Received data frames indicate the sender's address	All received RF data API frames indicate the source address.
Advanced ZigBee addressing support	API transmit and receive frames can expose ZigBee addressing fields including source and destination endpoints, cluster ID and profile ID. This makes it easy to support ZDO commands and public profile traffic.
Advanced networking diagnostics	API frames can provide indication of I/O samples from remote devices, and node identification messages.
Remote Configuration	Set and read configuration commands can be sent to remote devices to configure them as needed using the API.

Generally, API mode is recommended when a device:

- Sends RF data to multiple destinations
- Sends remote configuration commands to manage devices in the network
- Receives RF data packets from multiple devices, and the application needs to know which device sent which packet
- Must support multiple ZigBee endpoints, cluster IDs, and/or profile IDs
- Uses the ZigBee Device Profile services

API mode is required when:

- Using Smart Energy firmware
- Using SPI for the serial port
- Receiving I/O samples from remote devices
- Using source routing

If the above conditions do not apply (e.g. a sensor node, router, or a simple application), then transparent operation might be suitable. It is acceptable to use a mixture of devices running API mode and transparent mode in a network.

## Modes of operation

The XBee/XBee-PRO ZigBee RF Module is in Receive Mode when it is not transmitting data. The device shifts into the other modes of operation under the following conditions:

- Transmit Mode (Serial data in the serial receive buffer is ready to be packetized)
- Sleep Mode
- Command Mode (Command Mode Sequence is issued, not available when using the SPI port)

### Idle mode

When not receiving or transmitting data, the device is in Idle mode. During Idle mode, the device listens for valid data on both the RF and serial ports.

The device shifts into the other modes of operation under the following conditions:

- Transmit mode (serial data in the serial receive buffer is ready to be packetized)
- Receive mode (valid RF data received through the antenna)
- Sleep mode (End Devices only)
- Command mode (Command mode sequence issued, not available with Smart Energy software or when using the SPI port)

### Transmit mode

Prior to transmitting the data, the module ensures that a 16-bit network address and route to the destination node have been established.

If you do not know the destination 16-bit network address known, network address discovery takes place. If you do not know the a route is not known, route discovery takes place for the purpose of establishing a route to the destination node. If a device with a matching network address is not discovered, it discards the packet. The device transmits the data once a route is established. If route discovery fails to establish a route, the device discards the packet. The following diagram shows the Transmit Mode sequence.

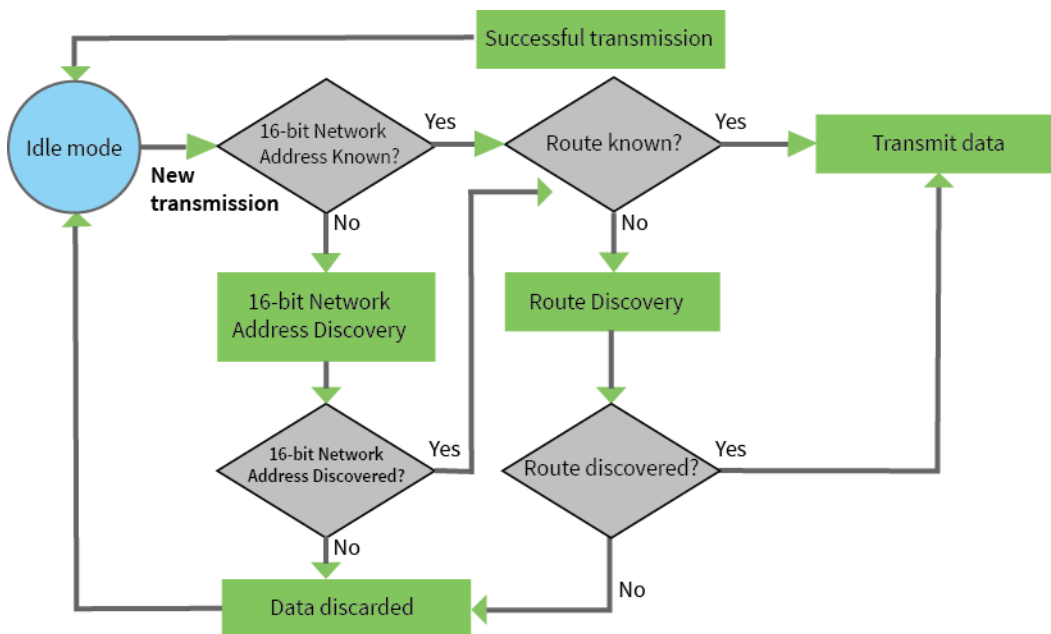

When ZigBee data is transmitted from one node to another, the destination node transmits a network-level acknowledgment back across the established route to the source node. This acknowledgment packet indicates to the source node that the destination node received the data packet. If the source node does not receive a network acknowledgment, it retransmits the data.

It is possible in rare circumstances for the destination to receive a data packet, but for the source to not receive the network acknowledgment. In this case, the source retransmits the data, which can cause the destination to receive the same data packet multiple times. The XBee modules do not filter out duplicate packets. We recommend that the application includes provisions to address this issue.

For more information, see [Transmission, addressing, and routing](#).

## Receive mode

This is the default mode for the XBee/XBee-PRO ZigBee RF Module. The device is in Receive mode when it is not transmitting data. If a destination node receives a valid RF packet, the destination node transfers the data to its serial transmit buffer.

## Command mode

Command mode is a state in which the firmware interprets incoming characters as commands. It is only available over the UART when not using the Smart Energy firmware. [API Operation](#) describes an alternate means for configuring modules which is available with the SPI and with Smart Energy, as well as over the UART with ZigBee code.

### Command mode

Send the 3-character command sequence “+++” and observe guard times before and after the command character.

Default Command mode sequence (for transition to Command mode):

- No characters sent for one second [**GT** (Guard Times) parameter = 0x3E8]
- Input three plus characters (“+++”) within one second [**CC** (Command Sequence Character) parameter = 0x2B.]
- No characters sent for one second [**GT** (Guard Times) parameter = 0x3E8]

Once the AT command mode sequence has been issued, the module sends an “OK\r” out the UART pad. The “OK\r” characters can be delayed if the module has not finished transmitting received serial data.

When the device has entered command mode, it starts the command mode timer (**CT** command), and the device can to receive AT commands the UART port.

You can modify all of the parameter values in the sequence to reflect user preferences.

---

**Note** Failure to enter AT Command Mode is most commonly due to baud rate mismatch. By default, the **BD** (Baud Rate) parameter = 3 (9600 b/s).

---

### Send AT commands

Once the device enters Command mode, use the syntax in the following figure to send AT commands. Every AT command starts with the letters **AT**, which stands for "attention." The **AT** is followed by two characters that indicate which command is being issued, then by some optional configuration values. To read a parameter value stored in the device’s register, omit the parameter field.



The preceding example changes the device's destination address (Low) to 0x1F.

To store the new value to non-volatile (long term) memory, send the **WR** (Write) command. This allows parameter values that you modify to persist in the device's registry after a reset. Otherwise, the device restores parameters to the previous values after a reset.

### Respond to AT commands

#### **Apply command changes**

Any changes you make to the configuration command registers using AT commands do not take effect until you apply the changes. For example, if you send the **BD** command to change the baud rate, the actual baud rate does not change until you apply the changes. To apply changes:

1. Send the **AC** (Apply Changes) command.  
or:
2. Exit Command mode.

#### **Exit Command mode**

1. Send the **CN** (Exit Command Mode) command followed by a carriage return.  
or:
2. If the device does not receive any valid AT commands within the time specified by **CT** (Command Mode Timeout), it returns to Idle Mode.

For an example of programming the device using AT Commands and descriptions of each configurable parameter, see [AT commands](#).

### Sleep Mode

Sleep modes allow the RF module to enter states of low power consumption when not in use. XBee RF modules support both pin sleep (sleep mode entered on pin transition) and cyclic sleep (module sleeps for a fixed time). XBee sleep modes are discussed in detail in [Managing End Devices](#).



## ZigBee networks

---

Introduction to XBee devices .....	50
ZigBee stack layers .....	50
ZigBee networking concepts .....	51
Zigbee application layers: in depth .....	54
ZigBee coordinator operation .....	56
ZigBee router operation .....	61
End device operation .....	66
ZigBee channel scanning .....	71

## Introduction to XBee devices

ZigBee is an open global standard for low-power, low-cost, low-data-rate, wireless mesh networking based on the IEEE 802.15.4 standard. It represents a network layer above the 802.15.4 layers to support advanced mesh routing capabilities. The ZigBee specification is developed by a growing consortium of companies that make up the ZigBee Alliance. The Alliance is made up of over 300 members, including semiconductor, module, stack, and software developers.

## ZigBee stack layers

Most network protocols use the concept of layers to separate different components and functions into independent modules that can be assembled in different ways.

ZigBee is built on the Physical (PHY) layer and Medium Access Control (MAC) sub-layer defined in the IEEE 802.15.4 standard. These layers handle low-level network operations such as addressing and message transmission/reception.

The ZigBee specification defines the Network (NWK) layer and the framework for the application layer. The Network layer takes care of the network structure, routing, and security. The application layer framework consists of the Application Support sub-layer (APS), the ZigBee Device Objects (ZDO) and user-defined applications that give the device its specific functionality.

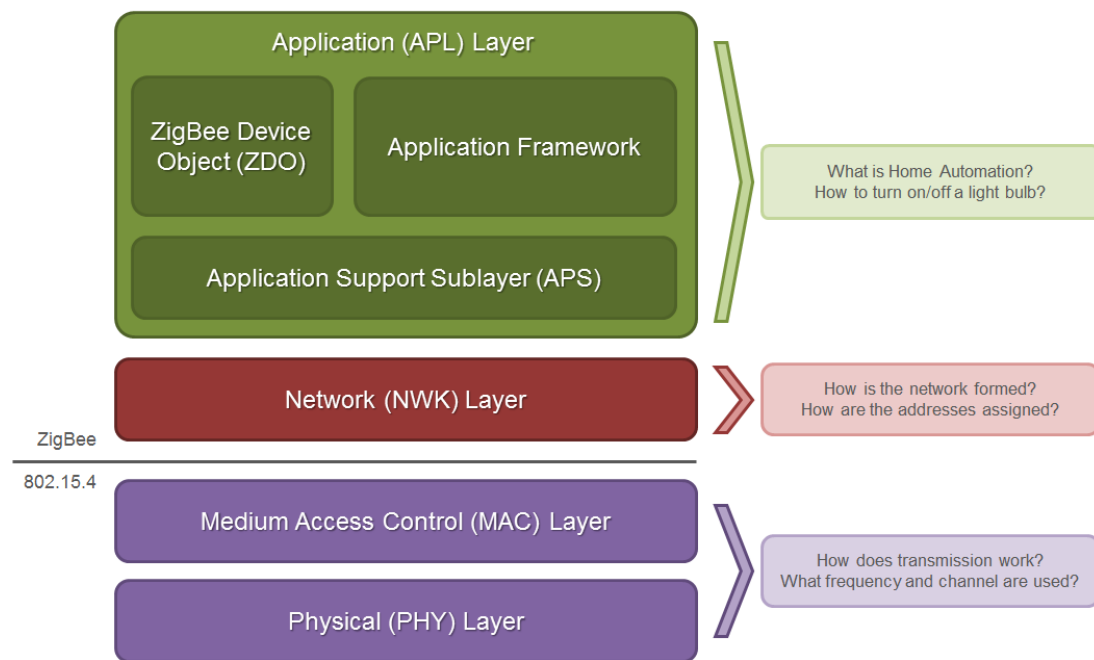

This table describes the ZigBee layers.

ZigBee layer	Descriptions
PHY	Defines the physical operation of the ZigBee device including receive sensitivity, channel rejection, output power, number of channels, chip modulation, and transmission rate specifications. Most ZigBee applications operate on the 2.4 GHz ISM band at a 250kb/s data rate. See the IEEE 802.15.4 specification for details.
MAC	Manages RF data transactions between neighboring devices (point to point). The MAC includes services such as transmission retry and acknowledgment management, and collision avoidance techniques (CSMA-CA).
Network	Adds routing capabilities that allows RF data packets to traverse multiple devices (multiple "hops") to route data from source to destination (peer to peer).
APS (AF)	Application layer that defines various addressing objects including profiles, clusters, and endpoints.
ZDO	Application layer that provides device and service discovery features and advanced network management capabilities.

## ZigBee networking concepts

### Device types

ZigBee defines three different device types: coordinator, router, and end device.



#### Coordinator

ZigBee networks always have a single coordinator device. This device:

- Starts the network, selecting the channel and PAN ID (both 64-bit and 16-bit).
- Distributes addresses, allowing routers and end devices to join the network. Assists in routing data.
- Buffers wireless data packets for sleeping end device children.
- Manages the other functions that define the network, secure it, and keep it healthy. Cannot sleep; the coordinator must be powered on all the time.



#### Router

A router is a full-featured ZigBee node. This device:

- Can join existing networks and send, receive, and route information. Routing involves acting as a messenger for communications between other devices that are too far apart to convey information on their own.
- Can buffer wireless data packets for sleeping end device children. Can allow other routers and end devices to join the network.
- Cannot sleep; router(s) must be powered on all the time.
- May have multiple router devices in a network.

## **E** End device

An end device is essentially a reduced version of a router. This device:

- Can join existing networks and send and receive information, but cannot act as messenger between any other devices.
- Cannot allow other devices to join the network.
- Uses less expensive hardware and can power itself down intermittently, saving energy by temporarily entering a nonresponsive sleep mode.
- Always needs a router or the coordinator to be its parent device. The parent helps end devices join the network, and stores messages for them when they are asleep.

ZigBee networks may have any number of end devices. In fact, a network can be composed of one coordinator, multiple end devices, and zero routers.

An example of such a network is shown in the following diagram:

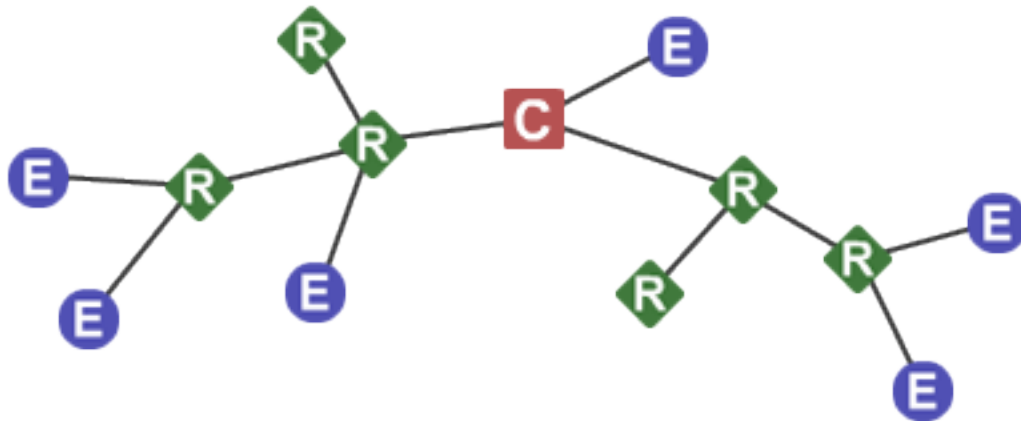

---

**Note** Each ZigBee network must be formed by one, and only one, coordinator and at least one other device (router or end device).

---

In ZigBee networks, the coordinator must select a PAN ID (64-bit and 16-bit) and channel to start a network. After that, it behaves essentially like a router. The coordinator and routers can allow other devices to join the network and can route data.

After an end device joins a router or coordinator, it must be able to transmit or receive RF data through that router or coordinator. The router or coordinator that allowed an end device to join becomes the “parent” of the end device. Since the end device can sleep, the parent must be able to buffer or retain incoming data packets destined for the end device until the end device is able to wake and receive the data.

A device can only operate as one of the three device types. The device type is selected by configuration rather than by firmware image as was the case on earlier hardware platforms.

By default, the device operates as a router in transparent mode. To select coordinator operation, set **CE** to 1. To select end device operation, set **SM** to a non-zero value. To select router operation, both **CE** and **SM** must be 0.

If a device is a coordinator and it needs to be changed into an end device, **CE** you must first set it back to 0. If not, the **SM** configuration will conflict with the **CE** configuration. Likewise, to change an end device into a coordinator, you must change it into a router first.

Another complication is that default parameters for a router build do not always work well for a coordinator build.

For example:

- **DH/DL** is 0 by default, which allows routers and end devices to send data to the coordinator when they first come up. If **DH/DL** is not changed from the default value when the device is changed to a coordinator, then the device sends data to itself, causing characters to be echoed back to the screen as they are typed. Since this is probably not the desired operation, set **DH/DL** to the broadcast address or some specific unicast address when the device is changed to a coordinator.
- Another example is **EO** for smart energy builds. Set this value to 08 for routers and end devices and 02 for the coordinator to designate it as the trust center. Therefore, if using authentication, which is the normal case for Smart Energy builds, change **EO** from 02 to 08 when **CE** is set to 1.
- Another example is **EO** for ZigBee builds. By default the value is 0x00. But if **EO** and **EE** are set to 0x01 on all radios in a network, then the network key will be sent in the clear (unencrypted) at association time. This may be a useful setting in development environments, but is discouraged for security reasons for product deployment.

In general, it is the user's responsibility to ensure that parameters are set to be compatible with the new device type when changing device types.

## PAN ID

ZigBee networks are called personal area networks or PANs. Each network is defined with a unique PAN identifier (PAN ID), which is common among all devices of the same network. ZigBee devices are either preconfigured with a PAN ID to join, or they can discover nearby networks and select a PAN ID to join.

ZigBee supports both a 64-bit and a 16-bit PAN ID. Both PAN IDs are used to uniquely identify a network. Devices on the same ZigBee network must share the same 64-bit and 16-bit PAN IDs. If multiple ZigBee networks are operating within range of each other, each should have unique PAN IDs.

### 16-bit PAN ID

The 16-bit PAN ID is used as a MAC layer addressing field in all RF data transmissions between devices in a network. However, due to the limited addressing space of the 16-bit PAN ID (65,535 possibilities), there is a possibility that multiple ZigBee networks (within range of each other) could use the same 16-bit PAN ID. To resolve potential 16-bit PAN ID conflicts, the ZigBee Alliance created a 64-bit PAN ID.

### 64-bit PAN ID

The 64-bit PAN ID (also called the extended PAN ID), is intended to be a unique, non-duplicated value. When a coordinator starts a network, it can either start a network on a preconfigured 64-bit PAN ID, or it can select a random 64-bit PAN ID. Devices use a 64-bit PAN ID during joining; if a device has a preconfigured 64-bit PAN ID, it will only join a network with the same 64-bit PAN ID. Otherwise, a device could join any detected PAN and inherit the PAN ID from the network when it joins. All ZigBee beacons include the 64-bit PAN ID and is used in 16-bit PAN ID conflict resolution.

### **Routers and end devices**

Routers and end devices are typically configured to join a network with any 16-bit PAN ID as long as the 64-bit PAN ID is valid. Coordinators typically select a random 16-bit PAN ID for their network.

Since the 16-bit PAN ID only allows up to 65,535 unique values, and the device randomly selects the 16-bit PAN ID, provisions exist in ZigBee to detect if two networks (with different 64-bit PAN IDs) are operating on the same 16-bit PAN ID. If the device detects a conflict, the ZigBee stack can perform PAN ID conflict resolution to change the 16-bit PAN ID of the network in order to resolve the conflict. See the ZigBee specification for details.

ZigBee routers and end devices should be configured with the 64-bit PAN ID of the network they want to join, and they typically acquire the 16-bit PAN ID when they join a network.

### **Operating channels**

ZigBee uses direct-sequence spread spectrum modulation and operates on a fixed channel. The 802.15.4 PHY defines 16 operating channels (channels 11 to 26) in the 2.4 GHz frequency band. XBee modules support all 16 channels.

## **Zigbee application layers: in depth**

This section provides a more in-depth look at the ZigBee application stack layers (APS, ZDO) including a discussion on ZigBee endpoints, clusters, and profiles. Much of the material in this section can introduce unnecessary details of the ZigBee stack that are not required in many cases.

Read this section if:

- The XBee/XBee-PRO ZigBee RF Module may talk to non-Digi ZigBee devices.
- The XBee/XBee-PRO ZigBee RF Module requires network management and discovery capabilities of the ZDO layer.
- The XBee/XBee-PRO ZigBee RF Module needs to operate in a public application profile (for example, smart energy, home automation, and so on).

Skip this section if:

- The XBee/XBee-PRO ZigBee RF Module does not need to interoperate or talk to non-Digi ZigBee devices.
- The XBee/XBee-PRO ZigBee RF Module simply needs to send data between devices.

### **Application Support Sublayer (APS)**

The APS layer in ZigBee adds support for application profiles, cluster IDs, and endpoints.

### **Application profiles**

Application profiles specify various device descriptions including required functionality for various devices. The collection of device descriptions forms an application profile. Application profiles can be defined as “Public” or “Private” profiles. Private profiles are defined by a manufacturer whereas public profiles are defined, developed, and maintained by the ZigBee Alliance. Each application profile has a unique profile identifier assigned by the ZigBee Alliance.

Examples of public profiles include:

- Home automation
- Smart Energy
- Commercial building automation

The Smart Energy profile, for example, defines various device types including an energy service portal, load controller, thermostat, in-home display, and so on. The Smart Energy profile defines required functionality for each device type. For example, a load controller must respond to a defined command to turn a load on or off. By defining standard communication protocols and device functionality, public profiles allow interoperable ZigBee solutions to be developed by independent manufacturers.

Digi XBee ZigBee firmware operates on a private profile called the Digi Drop-In Networking profile. However, API mode can be used in many cases to talk to devices in public profiles or non-Digi private profiles. For more information, see [API Operation](#).

## Clusters

A cluster is an application message type defined within a profile. You can use clusters to specify a unique function, service, or action. The following examples are some clusters defined in the home automation profile:

- On/Off - Used to switch devices on or off (lights, thermostats, etc.)
- Level Control - Used to control devices that can be set to a level between on and off
- Color Control - Controls the color of color capable devices

Each cluster has an associated 2-byte cluster identifier (cluster ID). All application transmissions include the cluster ID. Clusters often have associated request and response messages. For example, a smart energy gateway (service portal) might send a load control event to a load controller in order to schedule turning on or off an appliance. Upon executing the event, the load controller sends a load control report message back to the gateway.

Devices that operate in an application profile (private or public) must respond correctly to all required clusters. For example, a light switch that operates in the home automation public profile must correctly implement the On/Off and other required clusters in order to interoperate with other home automation devices. The ZigBee Alliance has defined a ZigBee Cluster Library (ZCL) that contains definitions or various general use clusters that could be implemented in any profile.

XBee modules implement various clusters in the Digi private profile. You can also use the API to send or receive messages on any cluster ID (and profile ID or endpoint). For more information, see [Explicit Rx Indicator frame - 0x91](#) frame.

## Endpoints

The APS layer includes supports for endpoints. An endpoint can be thought of as a running application, similar to a TCP/IP port. A single device can support one or more endpoints. A 1- byte value identifies each application endpoint, ranging from 1 to 240. Each defined endpoint on a device is tied to an application profile. A device could, for example, implement one endpoint that supports a Smart Energy load controller, and another endpoint that supports other functionality on a private profile.

## ZigBee device profile

Profile ID 0x0000 is reserved for the ZigBee Device Profile. This profile is implemented on all ZigBee devices. Device Profile defines many device and service discovery features and network management capabilities. Endpoint 0 is a reserved endpoint that supports the ZigBee Device Profile. This endpoint is called the ZigBee Device Objects (ZDO) endpoint.

### **ZigBee device objects**

The ZDO (endpoint 0) supports the discovery and management capabilities of the ZigBee Device Profile. See the ZigBee specification for a complete listing of all ZDP services. Each service has an associated cluster ID.

The XBee ZB firmware allows applications to easily send ZDO messages to devices in the network using the API. For more information, see [ZDO transmissions](#).

## **ZigBee coordinator operation**

### **Forming a network**

The coordinator is responsible for selecting the channel, PAN ID, security policy, and stack profile for a network. Since a coordinator is the only device type that can start a network, each ZigBee network must have one coordinator. After the coordinator has started a network, it can allow new devices to join the network. It can also route data packets and communicate with other devices on the network.

To ensure the coordinator starts on a good channel and unused PAN ID, the coordinator performs a series of scans to discover any RF activity on different channels (energy scan) and to discover any nearby operating PANs (PAN scan). The process for selecting the channel and PAN ID are described in the following topics.

### **Security policy**

The security policy determines which devices are allowed to join the network, and which device(s) can authenticate joining devices. See [ZigBee security](#) for a detailed discussion of various security policies.

### **Channel selection**

When starting a network, the coordinator must select a “good” channel for the network to operate on. To do this, it performs an energy scan on multiple channels (that is, frequencies) to detect energy levels on each channel. The coordinator removes channels with excessive energy levels from its list of potential channels to start on.

### **PAN ID selection**

After completing the energy scan, the coordinator scans its list of potential channels (remaining channels after the energy scan) to obtain a list of neighboring PANs. To do this, the coordinator sends a beacon request (broadcast) transmission on each potential channel. All nearby coordinators and routers that have already joined a ZigBee network respond to the beacon request by sending a beacon back to the coordinator. The beacon contains information about which PAN the device is on, including the PAN identifiers (16-bit and 64-bit). This scan (collecting beacons on the potential channels) is typically called an active scan or PAN scan.

After the coordinator completes the channel and PAN scan, it selects a random channel and unused 16-bit PAN ID to start on.

### **Persistent data**

Once a coordinator starts a network, it retains the following information through power cycle or reset events:

- PAN ID



- Operating channel
- Security policy and frame counter value
- Child table (end device children that are joined to the coordinator)
- Binding Table
- Group Table

The coordinator retains this information indefinitely until it leaves the network. When the coordinator leaves a network and starts a new network, the previous PAN ID, operating channel, and child table data are lost.

### Coordinator startup

The following table provides the network formation commands that the coordinator uses to form a network.

Command	Description
<b>ID</b>	Used to determine the 64-bit PAN ID. If set to 0 (default), a random 64-bit PAN ID will be selected.
<b>SC</b>	Determines the scan channels bitmask (up to 16 channels) used by the coordinator when forming a network. The coordinator will perform an energy scan on all enabled SC channels. It will then perform a PAN ID scan.
<b>SD</b>	Set the scan duration, or time that the router will listen for beacons on each channel.
<b>ZS</b>	Set the ZigBee stack profile for the network.
<b>EE</b>	Enable or disable security in the network.
<b>NK</b>	Set the network security key for the network. If set to 0 (default), the coordinator uses a random network security key.
<b>KY</b>	Set the trust center link key for the network. If set to 0 (default), the coordinator uses a random link key.
<b>EO</b>	Set the security policy for the network.

Configuration changes delay the start of network formation for five seconds after the last change. Once the coordinator starts a network, the network configuration settings and child table data persist through power cycles as mentioned in [Persistent data](#).

When the coordinator has successfully started a network, it:

- Allows other devices to join the network for a time (see [NJ \(Node Join Time\)](#))
- Sets **AI**=0
- Starts blinking the Associate LED
- Sends an API modem status frame (“coordinator started”) out the serial port when using API mode

These behaviors are configurable using the following commands:

Command	Description
<b>NJ</b>	Sets the permit-join time on the coordinator, measured in seconds.
<b>D5</b>	Enables the Associate LED functionality.
<b>LT</b>	Sets the Associate LED blink time when joined. If <b>LT</b> = 0, the default is 1 blink per 500 ms (coordinator) 250 ms (router/end device).

If any of the command values in the network formation commands table changes, the coordinator leaves its current network and starts a new network, possibly on a different channel.

**Note** Command changes must be applied (**AC** or **CN** command) before taking effect.

## Permit joining

The permit joining attribute on the coordinator is configurable with the **NJ** command. You can configure **NJ** to always allow joining, or to allow joining for a short time.

### Joining always enabled

If **NJ**=0xFF (default), joining is permanently enabled.



Use this mode carefully. Once a network has been deployed, we strongly recommend that the application consider disabling joining to prevent unwanted joins from occurring.

### Joining temporarily enabled

Set **NJ** < 0xFF, to enable joining for only a number of seconds, based on the **NJ** parameter. Once the XBee joins a network, the timer starts. The coordinator does not re-enable joining if the module is power cycled or reset. The following actions restart the permit-joining timer:

- Changing **NJ** to a different value (and applying changes with the **AC** or **CN** commands)
- Pressing the commissioning button twice
- Issuing the **CB** command with a parameter of 2

The last two actions enable joining for one minute if **NJ** is 0x0 or 0xFF. Otherwise, the commissioning button and the CB2 command enable joining for **NJ** seconds.

## Resetting the coordinator

When you reset or power cycle the coordinator, it checks its PAN ID, operating channel and stack profile against the network configuration settings (**ID**, **CH**, **ZS**). It also verifies the saved security policy against the security configuration settings (**EE**, **NK**, **KY**). If the coordinator's PAN ID, operating channel, stack profile, or security policy is not valid based on its network and security configuration settings, the coordinator leaves the network and attempts to form a new network based on its network formation command values.

To prevent the coordinator from leaving an existing network, issue the **WR** command after all network formation commands have been configured in order to retain these settings through power cycle or reset events.

## Leave a network

The following mechanisms cause the coordinator to leave its current PAN and start a new network based on its network formation parameter values.

- Change the **ID** command such that the current 64-bit PAN ID is invalid.
- Change the **SC** command such that the current channel (**CH**) is not included in the channel mask.
- Change the **ZS** or any of the security command values (excluding **NK**).
- Issue the **NR0** command to cause the coordinator to leave.
- Issue the **NR1** command to send a broadcast transmission, causing all devices in the network to leave and migrate to a different channel.
- Press the commissioning button 4 times or issue the **CB** command with a parameter of 4.
- Issue a network leave command.

---

**Note** Changes to **ID**, **SC**, **ZS**, and security command values only take effect when changes are applied (**AC** or **CN** commands).

---

## Replacing a coordinator (security disabled only)

On rare occasions, it may become necessary to replace an existing coordinator in a network with a new physical device. If security is not enabled in the network, you can configure a replacement XBee coordinator with the PAN ID (16-bit and 64-bit), channel, and stack profile settings of a running network in order to replace an existing coordinator.

---

**Note** Avoid having two coordinators on the same channel, stack profile, and PAN ID (16-bit and 64-bit) as it can cause problems in the network. When replacing a coordinator, turn off the old coordinator before starting the new coordinator.

---

To replace a coordinator, read the following commands from a device on the network:

Command	Description
<b>OP</b>	Read the operating 64-bit PAN ID.
<b>OI</b>	Read the operating 16-bit PAN ID.
<b>CH</b>	Read the operating channel.
<b>ZS</b>	Read the stack profile.

Each of the commands listed above can be read from any device on the network. These parameters will be the same on all devices in the network. After reading the commands from a device on the network, program the parameter values into the new coordinator using the following commands.

Command	Description
<b>ID</b>	Set the 64-bit PAN ID to match the read <b>OP</b> value.

Command	Description
<b>II</b>	Set the initial 16-bit PAN ID to match the read <b>OI</b> value.
<b>SC</b>	Set the scan channels bitmask to enable the read operating channel ( <b>CH</b> command). For example, if the operating channel is 0x0B, set <b>SC</b> to 0x0001. If the operating channel is 0x17, set <b>SC</b> to 0x1000.
<b>ZS</b>	Set the stack profile to match the read <b>ZS</b> value.

**II** is the initial 16-bit PAN ID. Under certain conditions, the ZigBee stack can change the 16-bit PAN ID of the network. For this reason, you cannot save the **II** command using the **WR** command. Once **II** is set, the coordinator leaves the network and starts on the 16-bit PAN ID specified by **II**.

### Example: start a coordinator

1. Set **CE** (Coordinator Enable) to 1 or load coordinator firmware on the device, and use the **WR** command to save the changes.
2. Set **SC** and **ID** to the desired scan channels and PAN ID values. The defaults are sufficient.
3. If you change **SC** or **ID** from the default, issue the **WR** command to save the changes.
4. If you change **SC** or **ID** from the default, apply changes (make **SC** and **ID** changes take effect) either by sending the **AC** command or by exiting **AT** command mode.
5. If an Associate LED has been connected, it starts blinking once the coordinator has selected a channel and PAN ID.
6. The API Modem Status frame (“Coordinator Started”) is sent out the serial port when using API mode.
7. Reading the **AI** command (association status) returns a value of 0, indicating a successful startup.
8. Reading the **MY** command (16-bit address) returns a value of 0, the ZigBee-defined 16-bit address of the coordinator.

After startup, the coordinator allows joining based on its **NJ** value.

### Example: replace a coordinator (security disabled)

1. Read the **OP**, **OI**, **CH**, and **ZS** commands on the running coordinator.
2. Set the **CE**, **ID**, **SC**, and **ZS** parameters on the new coordinator or load coordinator firmware on the module, followed by **WR** command to save these parameter values.
3. Turn off the running coordinator.
4. Set the **II** parameter on the new coordinator to match the read **OI** value on the old coordinator.
5. Wait for the new coordinator to start (**AI**=0).

## ZigBee router operation

Routers must discover and join a valid ZigBee network before they can participate in a ZigBee network. After a router has joined a network, it can allow new devices to join the network. It can also route data packets and communicate with other devices on the network.

### Discovering ZigBee networks

To discover nearby ZigBee networks, the router performs a PAN (or active) scan, just like the coordinator does when it starts a network. During the PAN scan, the router sends a beacon request (broadcast) transmission on the first channel in its scan channels list. All nearby coordinators and routers operating on that channel that are already part of a ZigBee network respond to the beacon request by sending a beacon back to the router.

The beacon contains information about the PAN the nearby device is on, including the PAN identifier (PAN ID), and whether or not joining is allowed. The router evaluates each beacon received on the channel to determine if it finds a valid PAN. A PAN is valid if any of the following exist:

- Has a valid 64-bit PAN ID (PAN ID matches **ID** if **ID** > 0)
- Has the correct stack profile (**ZS** command)
- Allows joining the network

If the router does not find a valid PAN, it performs the PAN scan on the next channel in its scan channels list and continues scanning until it finds a valid network, or until all channels have been scanned. If the router scans all channels and does not discover a valid PAN, it scans all channels again.

The ZigBee Alliance requires that certified solutions not send beacon request messages too frequently. To meet certification requirements, the XBee firmware attempts nine scans per minute for the first five minutes, and three scans per minute thereafter. If a valid PAN is within range of a joining router, it typically discovers the PAN within a few seconds.

### Joining a network

Once the router discovers a valid network, it sends an association request to the device that sent a valid beacon requesting a join on the ZigBee network. The device allowing the join then sends an association response frame that either allows or denies the join.

When a router joins a network, it receives a 16-bit address from the device that allowed the join. The device that allowed the join randomly selects the 16-bit address.

### Authentication

In a network where security is enabled, the router must follow an authentication process. See [ZigBee security](#) for a discussion on security and authentication.

After the router is joined (and authenticated, in a secure network), it can allow new devices to join the network.

### Persistent data

Once a router joins a network, it retains the following information through power cycle or reset events:

- PAN ID
- Operating channel

- Security policy and frame counter values
- Child table (end device children that are joined to the coordinator)
- Binding Table
- Group Table

The router retains this information indefinitely until it leaves the network. When the router leaves a network, it loses the previous PAN ID, operating channel, and child table data.

## ZigBee router joining

When the router powers on, if it is not already joined to a valid ZigBee network, it immediately attempts to find and join a valid ZigBee network.

Set the **DJ** command to 1 to disable joining. You cannot write the **DJ** parameter with the **WR** command, so a power cycle always clears the **DJ** setting.

The following commands control the router joining process.

Command	Description
<b>ID</b>	Sets the 64-bit PAN ID to join. Setting ID=0 allows the router to join any 64-bit PAN ID.
<b>SC</b>	Set the scan channels bitmask that determines which channels a router scans to find a valid network. Set <b>SC</b> on the router to match <b>SC</b> on the coordinator. For example, setting <b>SC</b> to 0x281 enables scanning on channels 0x0B, 0x12, and 0x14, in that order.
<b>SD</b>	Set the scan duration, or time that the router listens for beacons on each channel.
<b>ZS</b>	Set the stack profile on the device.
<b>EE</b>	Enable or disable security in the network. This must be set to match the <b>EE</b> value (security policy) of the coordinator.
<b>KY</b>	Set the trust center link key. If set to 0 (default), the link key is expected to be obtained (unencrypted) during joining.

Configuration changes delay the start of joining for 5 seconds after the last change.

Once the router joins a network, the network configuration settings and child table data persist through power cycles as mentioned in [Persistent data](#). If joining fails, read the status of the last join attempt in the **AI** command register.

If any of the above command values change, when command register changes are applied (**AC** or **CN** commands), the router leaves its current network and attempts to discover and join a new valid network. When a ZB router has successfully joined a network, it:

- Allows other devices to join the network for a time
- Sets AI=0
- Starts blinking the Associate LED
- Sends an API modem status frame (“associated”) out the serial port when using API mode

You can configure these behaviors using the following commands:

Command	Description
<b>NJ</b>	Sets the permit-join time on the router, or the time that it allows new devices to join the network, measured in seconds. Set NJ=0xFF to always enable permit joining.
<b>D5</b>	Enables the Associate LED functionality.
<b>LT</b>	Sets the Associate LED blink time when joined. The default is 2 blinks per second (router).

## Permit joining

The permit joining attribute on the coordinator is configurable with the **NJ** command. You can configure **NJ** to always allow joining, or to allow joining for a short time.

### Joining always enabled

If **NJ**=0xFF (default), joining is permanently enabled.



Use this mode carefully. Once a network has been deployed, we strongly recommend that the application consider disabling joining to prevent unwanted joins from occurring.

### Joining temporarily enabled

Set **NJ** < 0xFF, to enable joining for only a number of seconds, based on the **NJ** parameter. Once the XBee joins a network, the timer starts. The coordinator does not re-enable joining if the module is power cycled or reset. The following actions restart the permit-joining timer:

- Changing **NJ** to a different value (and applying changes with the **AC** or **CN** commands)
- Pressing the commissioning button twice
- Issuing the **CB** command with a parameter of 2

The last two actions enable joining for one minute if **NJ** is 0x0 or 0xFF. Otherwise, the commissioning button and the CB2 command enable joining for **NJ** seconds.

## Router network connectivity

Once a router joins a ZigBee network, it remains connected to the network on the same channel and PAN ID unless it is forced to leave (see [Leave a network](#)). If the scan channels (**SC**), PAN ID (**ID**) and security settings (**EE**, **KY**) do not change after a power cycle, the router remains connected to the network after a power cycle.

If a router is physically moved out of range of the network it initially joined, make sure the application includes provisions to detect if the router can still communicate with the original network . If communication with the original network is lost, the application may choose to force the router to leave the network (see [Leave a network](#)). The XBee firmware includes two provisions to automatically detect the presence of a network and leave if the check fails.

### Power-On join verification

The **JV** command (join verification) enables the power-on join verification check. If enabled, the XBee module attempts to discover the 64-bit address of the coordinator when it first joins a network. Once

it has joined, it also attempts to discover the 64-bit address of the coordinator after a power cycle event. If 3 discovery attempts fail, the router leaves the network and try to join a new network. The default setting for Power-on join verification is disabled (**JV** defaults to 0).

### **Network watchdog**

Use the **NW** command (network watchdog timeout) for a powered router to periodically check for the presence of a coordinator to verify network connectivity. The **NW** command specifies a timeout in minutes where the router must receive communication from the coordinator or data collector. The following events restart the network watchdog timer:

- RF data received from the coordinator
- RF data sent to the coordinator and an acknowledgment was received
- Many-to-one route request was received (from any device)
- Change the value of **NW**

If the watchdog timer expires (no valid data received for **NW** time), the router attempts to discover the 64-bit address of the coordinator. If the router cannot discover the address, it records one watchdog timeout. After three consecutive network watchdog timeouts expire (3 \* **NW**) and the coordinator has not responded to the address discovery attempts, the router leaves the network and attempts to join a new network.

Anytime a router receives valid data from the coordinator or data collector, it clears the watchdog timeouts counter and restarts the watchdog timer. You can set the watchdog timer (**NW** command) to several days. The default setting for the network watchdog feature is disabled (**NW** defaults to 0).



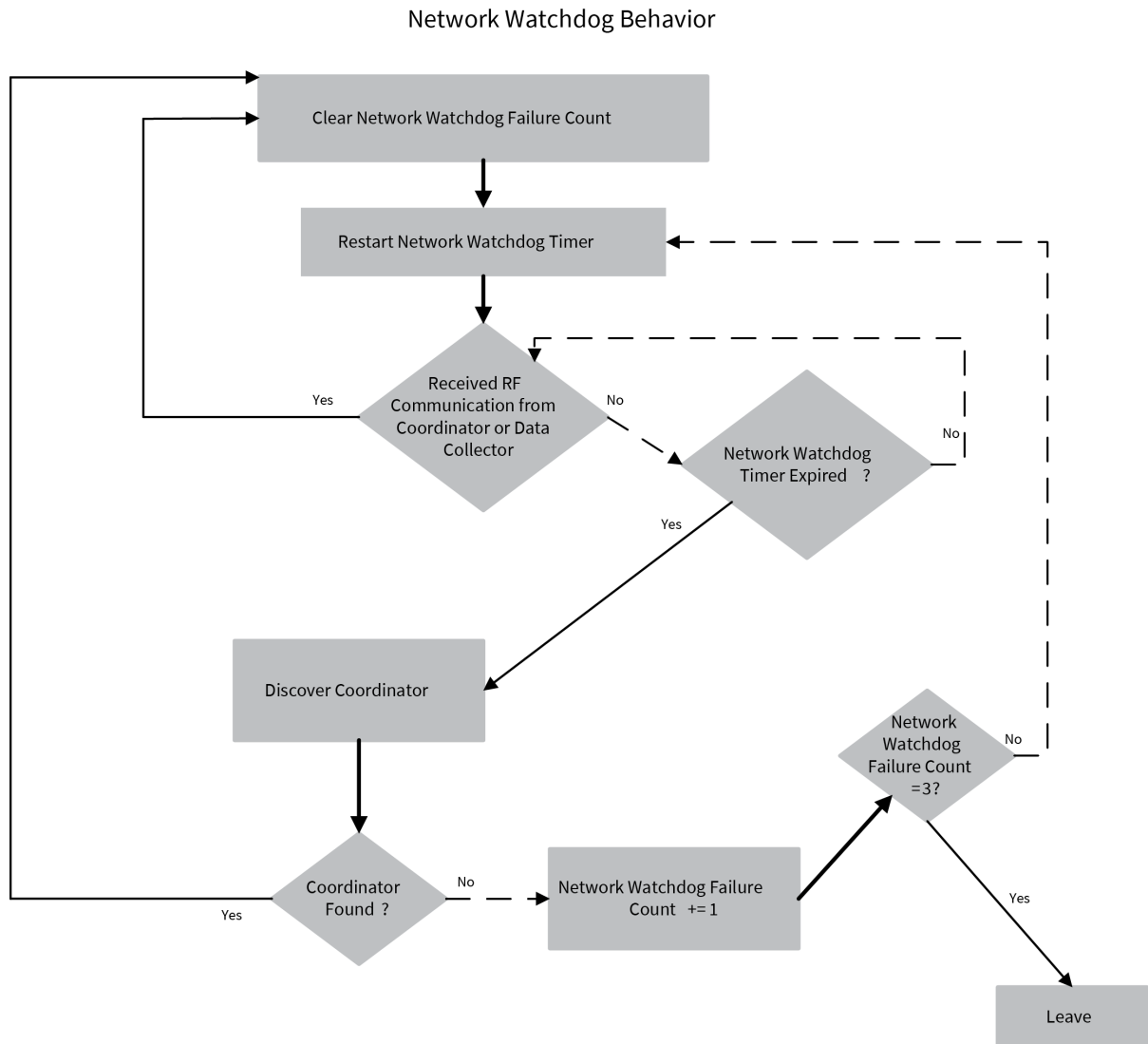

### Leave a network

The following mechanisms cause the coordinator to leave its current PAN and start a new network based on its network formation parameter values.

- Change the **ID** command such that the current 64-bit PAN ID is invalid.
- Change the **SC** command such that the current channel (**CH**) is not included in the channel mask.
- Change the **ZS** or any of the security command values (excluding **NK**).
- Issue the **NR0** command to cause the coordinator to leave.
- Issue the **NR1** command to send a broadcast transmission, causing all devices in the network to leave and migrate to a different channel.
- Press the commissioning button 4 times or issue the **CB** command with a parameter of 4.
- Issue a network leave command.

---

**Note** Changes to **ID**, **SC**, **ZS**, and security command values only take effect when changes are applied (**AC** or **CN** commands).

---

### **Network Locator option**

The Device Options Network Locator option supports swapping or replacing a Coordinator in a running network. The Network Locator option, if enabled (ATDO80), modifies the behavior of the **JV** and **NW** options. If there is no communication with the Coordinator, the radio starts a search for the network across the channels of the Search Channel mask (**SC**) rather than leaving the network.

If the device finds a network on the old channel with the same **OI** (operating ID), the search mode ends and reschedules **NW** if enabled. If the device finds a network with a new **OI** but satisfies the radio's search for a matching **ID** and **ZS**, the radio leaves the old network and joins the new network with the new **OI**.

### **Resetting the Router**

When you reset or power cycle the router, it checks its PAN ID, operating channel and stack profile against the network configuration settings (**ID**, **SC**, **ZS**). It also verifies the saved security policy is valid based on the security configuration commands (**EE**, **KY**). If the router's PAN ID, operating channel, stack profile, or security policy is invalid, the router leaves the network and attempts to join a new network based on its network joining command values.

To prevent the router from leaving an existing network, issue the **WR** command after all network joining commands have been configured; this retains the settings through power cycle or reset events.

### **Example: joining a network**

After starting a coordinator that is allowing joins, the following steps cause a router to join the network:

1. Set **ID** to the desired 64-bit PAN ID, or to 0 to join any PAN.
2. Set **SC** to the list of channels to scan to find a valid network.
3. If you **SC** or **ID** from the default, apply changes (that is, make **SC** and **ID** changes take effect) by issuing the **AC** or **CN** command.
4. The Associate LED starts blinking once the router has joined a PAN.
5. If the Associate LED is not blinking, read the **AI** command to determine the cause of join failure.
6. Once the router joins, the **OP** and **CH** commands indicate the operating 64-bit PAN ID and channel the router joined.
7. The **MY** command reflects the 16-bit address the router received when it joined.
8. The API Modem Status frame ("Associated") is sent out the serial port when using API mode.
9. The joined router allows other devices to join for a time based on its **NJ** setting.

## **End device operation**

Similar to routers, end devices must discover and join a valid ZigBee network before they can participate in the network. After an end device joins a network, it can communicate with other devices on the network. Because end devices are battery powered and support low power (sleep) modes, they cannot allow other devices to join or route data packets.

## Discover ZigBee networks

End devices go through the same process as routers to discover networks by issuing a PAN scan. After sending the broadcast beacon request transmission, the end device listens for a short time in order to receive beacons sent by nearby routers and coordinators on the same channel. The end device evaluates each beacon received on the channel to determine if it finds a valid PAN. A PAN is valid if any of the following exist:

- Has a valid 64-bit PAN ID (PAN ID matches ID if ID > 0)
- Has the correct stack profile (**ZS** command)
- Allows joining the network
- Has capacity for additional end devices

If the end device does not find a valid PAN, it performs the PAN scan on the next channel in its scan channels list and continues this process until it finds a valid network, or until all channels have been scanned. If the end device scan all channels and does not discover a valid PAN, it may enter a low power sleep state and scan again later.

If scanning all **SC** channels fails to discover a valid PAN, XBee ZigBee devices attempt to enter a low power state and retries scanning all **SC** channels after the device wakes from sleeping. If the device cannot enter a low power state, it retries scanning all channels, similar to the router. To meet ZigBee Alliance requirements, the end device attempts up to nine scans per minute for the first five minutes, and three scans per minute thereafter.

---

**Note** The XBee ZigBee end device will not enter sleep until it has completed scanning all **SC** channels for a valid network.

---

## Joining a network

Once the end device discovers a valid network, it joins the network, similar to a router, by sending an association request (to the device that sent a valid beacon) to request a join on the ZigBee network. The device allowing the join then sends an association response frame that either allows or denies the join.

When an end device joins a network, it receives a 16-bit address from the device that allowed the join. The device that allowed the join randomly selects the 16-bit address.

### ***Parent child relationship***

Since an end device may enter low power sleep modes and not be immediately responsive, the end device relies on the device that allowed the join to receive and buffer incoming messages on its behalf until it is able to wake and receive those messages. The device that allowed an end device to join becomes the parent of the end device, and the end device becomes a child of the device that allowed the join.

## End device capacity

Routers and coordinators maintain a table of all child devices that have joined called the child table. This table is a finite size and determines how many end devices can join. If a router or coordinator has at least one unused entry in its child table, the device has end device capacity. In other words, it can allow one or more additional end devices to join. ZigBee networks have sufficient routers to ensure adequate end device capacity.

The initial release of software on this platform supports up to 20 end devices when configured as a coordinator or a router.

In ZigBee firmware, use the **NC** command (number of remaining end device children) to determine how many additional end devices can join a router or coordinator. If **NC** returns 0, then the router or coordinator device has no more end device capacity.

---

**Note** Because routers cannot sleep, there is no equivalent need for routers or coordinators to track joined routers. There is no limit to the number of routers that can join a given router or coordinator device and no “router capacity” metric.

---

### Authentication

In a network where security is enabled, the end device must then go through an authentication process. For more information, see [ZigBee security](#).

### Persistent data

The end device can retain its PAN ID, operating channel, and security policy information through a power cycle. However, since end devices rely heavily on a parent, the end device does an orphan scan to try and contact its parent. If the end device does not receive an orphan scan response (coordinator realignment command), it leaves the network and tries to discover and join a new network. When the end device leaves a network, it loses the previous PAN ID and operating channel settings.

### Orphan scans

When an end device comes up from a power cycle, it performs an orphan scan to verify it still has a valid parent. The device sends the orphan scan as a broadcast transmission and contains the 64-bit address of the end device. Nearby routers and coordinator devices that receive the broadcast check their child tables for an entry that contains the end device's 64-bit address. If the devices find an entry with a matching 64-bit address, they send a coordinator realignment command to the end device that includes the 16-bit address of the end device, 16-bit PAN ID, operating channel, and the parent's 64-bit and 16-bit addresses.

If the orphaned end device receives a coordinator realignment command, it joins the network. Otherwise, it attempts to discover and join a valid network.

### End device joining

When you power on an end device, if it is not joined to a valid ZigBee network, or if the orphan scan fails to find a parent, the device attempts to find and join a valid ZigBee network.

---

**Note** Set the **DJ** command to 1 to disable joining. You cannot write the **DJ** parameter with **WR**, so a power cycle always clears the **DJ** setting.

---

Similar to a router, the following commands control the end device joining process.

Command	Description
<b>ID</b>	Sets the 64-bit PAN ID to join. Setting ID=0 allows the router to join any 64-bit PAN ID.
<b>SC</b>	Set the scan channels bitmask that determines which channels an end device will scan to find a valid network. <b>SC</b> on the end device should be set to match <b>SC</b> on the coordinator and routers in the desired network. For example, setting <b>SC</b> to 0x281 enables scanning on channels 0x0B, 0x12, and 0x14, in that order.

Command	Description
<b>SD</b>	Set the scan duration, or time that the end device will listen for beacons on each channel.
<b>ZS</b>	Set the stack profile on the device.
<b>EE</b>	Enable or disable security in the network. This must be set to match the <b>EE</b> value (security policy) of the coordinator.
<b>KY</b>	Set the trust center link key. If set to 0 (default), the link key is expected to be obtained (unencrypted) during joining.

Once the end device joins a network, the network configuration settings persist through power cycles as mentioned in [Persistent data](#). If joining fails, read the status of the last join attempt in the **AI** command register.

If any of these command values change when command register changes are applied, the end device leaves its current network and attempts to discover and join a new valid network.

When a ZB end device has successfully started a network, it:

- Sets **AI** equal to 0
- Starts blinking the Associate LED if one has been connected to the module's ASSC pin
- Sends an API modem status frame (“associated”) out the serial port when using API mode
- Attempts to enter low power modes

These behaviors are configurable using the following commands:

Command	Description
<b>D5</b>	Enables the Associate LED functionality.
<b>LT</b>	Sets the Associate LED blink time when joined. Default is 2 blinks per second (end devices).
<b>SM, SP, ST, SN, SO</b>	Parameters that configure the sleep mode characteristics.

## Parent connectivity

The XBee ZB end device sends regular poll transmissions to its parent when it is awake. These poll transmissions query the parent for any new received data packets. The parent always sends a MAC layer acknowledgment back to the end device. The acknowledgment indicates whether the parent has data for the end device.

If the end device does not receive an acknowledgment for 3 consecutive poll requests, it considers itself disconnected from its parent and attempts to discover and join a valid ZigBee network. For more information, see [Managing End Devices](#).

## Resetting the end device

When the end device is reset or power cycled, if the orphan scan successfully locates a parent, the end device then checks its PAN ID, operating channel and stack profile against the network configuration settings (**ID, SC, ZS**). It also verifies the saved security policy is valid based on the security configuration commands (**EE, KY**). If the end device's PAN ID, operating channel, stack profile, or

security policy is invalid, the end device will leave the network and attempt to join a new network based on its network joining command values.

To prevent the end device from leaving an existing network, the *WR* command should be issued after all network joining commands have been configured in order to retain these settings through power cycle or reset events.

## Leaving a network

The following mechanisms cause the coordinator to leave its current PAN and start a new network based on its network formation parameter values.

- Change the **ID** command such that the current 64-bit PAN ID is invalid.
- Change the **SC** command such that the current channel (**CH**) is not included in the channel mask.
- Change the **ZS** or any of the security command values (excluding **NK**).
- Issue the **NR0** command to cause the coordinator to leave.
- Issue the **NR1** command to send a broadcast transmission, causing all devices in the network to leave and migrate to a different channel.
- Press the commissioning button four times or issue the **CB** command with a parameter of 4.
- The parent of the end device parent powers down or the end device moves out of range of the parent such that the end device fails to receive poll acknowledgment messages.

---

**Note** Changes to command values only take effect when changes are applied (**AC** or **CN** commands).

---

## Example: joining a network

After starting a coordinator that is allowing joins, the following steps cause a router to join the network:

1. Set **ID** to the desired 64-bit PAN ID, or to 0 to join any PAN.
2. Set **SC** to the list of channels to scan to find a valid network.
3. If you **SC** or **ID** from the default, apply changes (that is, make **SC** and **ID** changes take effect) by issuing the **AC** or **CN** command.
4. The Associate LED starts blinking once the router has joined a PAN.
5. If the Associate LED is not blinking, read the **AI** command to determine the cause of join failure.
6. Once the router joins, the **OP** and **CH** commands indicate the operating 64-bit PAN ID and channel the end device joined.
7. The **MY** command reflects the 16-bit address the router received when it joined.
8. The API Modem Status frame (“Associated”) is sent out the serial port when using API mode.
9. The joined end device attempts to enter low power sleep modes based on its sleep configuration commands (**SM**, **SP**, **SN**, **ST**, **SO**).

## ZigBee channel scanning

Routers and end devices must scan one or more channels to discover a valid network to join. When a join attempt begins, the device sends a beacon request transmission on the lowest channel specified in the **SC** (scan channels) command bitmask. If the device finds a valid PAN on the channel, it attempts to join the PAN on that channel. Otherwise, if the device does not find a valid PAN on the channel, it attempts scanning on the next higher channel in the **SC** command bitmask.

The device continues to scan each channel (from lowest to highest) in the **SC** bitmask until it finds a valid PAN or all channels have been scanned. Once the device scans all channels, the next join attempt starts scanning on the lowest channel specified in the **SC** command bitmask.

For example, if the **SC** command is set to 0x400F, the device starts scanning on channel 11 (0x0B) and scans until it finds a valid beacon, or until it scans channels 11, 12, 13, 14, and 25 have been scanned (in that order).

Once an XBee router or end device joins a network on a given channel, if the XBee device receives a network leave command (see [Leave a network](#)), it leaves the channel it joined on and continues scanning on the next higher channel in the **SC** bitmask.

For example, if the **SC** command is set to 0x400F and the device joins a PAN on channel 12 (0x0C), if the XBee device leaves the channel, it starts scanning on channel 13, followed by channels 14 and 25 if it does not find a valid network. Once all channels have been scanned, the next join attempt starts scanning on the lowest channel specified in the **SC** command bitmask.

## Managing multiple ZigBee networks

In some applications, multiple ZigBee networks may exist in proximity of each other. The application may need provisions to ensure the device joins the desired network. There are a number of features in ZigBee to manage joining among multiple networks. These include the following:

- PAN ID Filtering
- Preconfigured Security Keys
- Permit Joining
- Application Messaging

### PAN ID filtering

You can configure the XBee device with a fixed PAN ID by setting the ID command to a non-zero value. If you set the PAN ID to a non-zero value, the XBee will only join a network with the same PAN ID.

### Pre-configured security keys

Similar to PAN ID filtering, this method requires a known security key be installed on a router to ensure it joins a ZigBee network with the same security key. If you set the security key (**KY** command) to a non-zero value, and if security is enabled (**EE** command), an XBee router or end device will only join a network with the same security key.

### Permit joining

You can disable the Permit Joining parameter in a network to prevent unwanted devices from joining. When a new device must be added to a network, enable permit-joining for a short time on the desired network. In the XBee firmware, disable joining by setting the **NJ** command to a value less than 0xFF on all routers and coordinator devices. Enable joining for a short time using the commissioning push-button (for more information, see [Network commissioning and diagnostics](#)) or the **CB** command.

## Application messaging

If none of these mechanisms are feasible, the application can build in a messaging framework between the coordinator and devices that join its network. For example, the application code in joining devices could send a transmission to the coordinator after joining a network, and wait to receive a defined reply message. If the application does not receive the expected response message after joining, it could force the device to leave and continue scanning (see [NR \(Network Reset\)](#)).



## Transmission, addressing, and routing

---

Addressing .....	74
Data transmission .....	74
Binding transmissions .....	77
Multicast transmissions .....	78
Fragmentation .....	78
Data transmission examples .....	78
RF packet routing .....	81
Encrypted transmissions .....	90
Maximum RF payload size .....	90
Throughput .....	92
ZDO transmissions .....	93
Transmission timeouts .....	95

## Addressing

All ZigBee devices have two different addresses, a 64-bit and a 16-bit address. This section describes the characteristics of each.

### 64-bit device addresses

The 64-bit address is a device address which is unique to each physical device. It is sometimes also called the MAC address or extended address and is assigned during the manufacturing process. The first three bytes of the 64-bit address is a Organizationally Unique Identifier (OUI) assigned to the manufacturer by the IEEE. The OUI of XBee devices is 0x0013A2.

### 16-bit device addresses

A device receives a 16-bit address when it joins a ZigBee network. For this reason, the 16-bit address is also called the network address. The 16-bit address of 0x0000 is reserved for the coordinator. All other devices receive a randomly generated address from the router or coordinator device that allows the join. The 16-bit address can change under certain conditions:

- An address conflict is detected where two devices are found to have the same 16-bit address
- A device leaves the network and later joins (it can receive a different address)

All ZigBee transmissions are sent using the source and destination 16-bit addresses. The routing tables on ZigBee devices also use 16-bit addresses to determine how to route data packets through the network. However, since the 16-bit address is not static, it is not a reliable way to identify a device.

To solve this problem, the 64-bit destination address is often included in data transmissions to guarantee data is delivered to the correct destination. The ZigBee stack can discover the 16-bit address, if unknown, before transmitting data to a remote.

### Application layer addressing

ZigBee devices support multiple application profiles, cluster IDs, and endpoints (for more information, see [Zigbee application layers: in depth](#)). Application layer addressing allows data transmissions to be addressed to specific profile IDs, cluster IDs, and endpoints. Application layer addressing is useful if an application must do any of the following:

- Interoperate with other ZigBee devices outside of the Digi application profile.
- Use service and network management capabilities of the ZDO.
- Operate on a public application profile such as Home Controls or Smart Energy.

API mode provides a simple yet powerful interface that easily sends data to any profile ID, endpoint, and cluster ID combination on any device in a ZigBee network.

## Data transmission

You can send ZigBee data packets as either unicast or broadcast transmissions. Unicast transmissions route data from one source device to one destination device, whereas broadcast transmissions are sent to many or all devices in the network.

### Broadcast transmissions

Broadcast transmissions within the ZigBee protocol are intended to be propagated throughout the entire network such that all nodes receive the transmission. To accomplish this, the coordinator and

all routers that receive a broadcast transmission retransmits the packet three times.

**Note** When a router or coordinator delivers a broadcast transmission to an end device child, the transmission is only sent once (immediately after the end device wakes and polls the parent for any new data). For more information, see [Parent operation](#).

### Broadcast data transmission

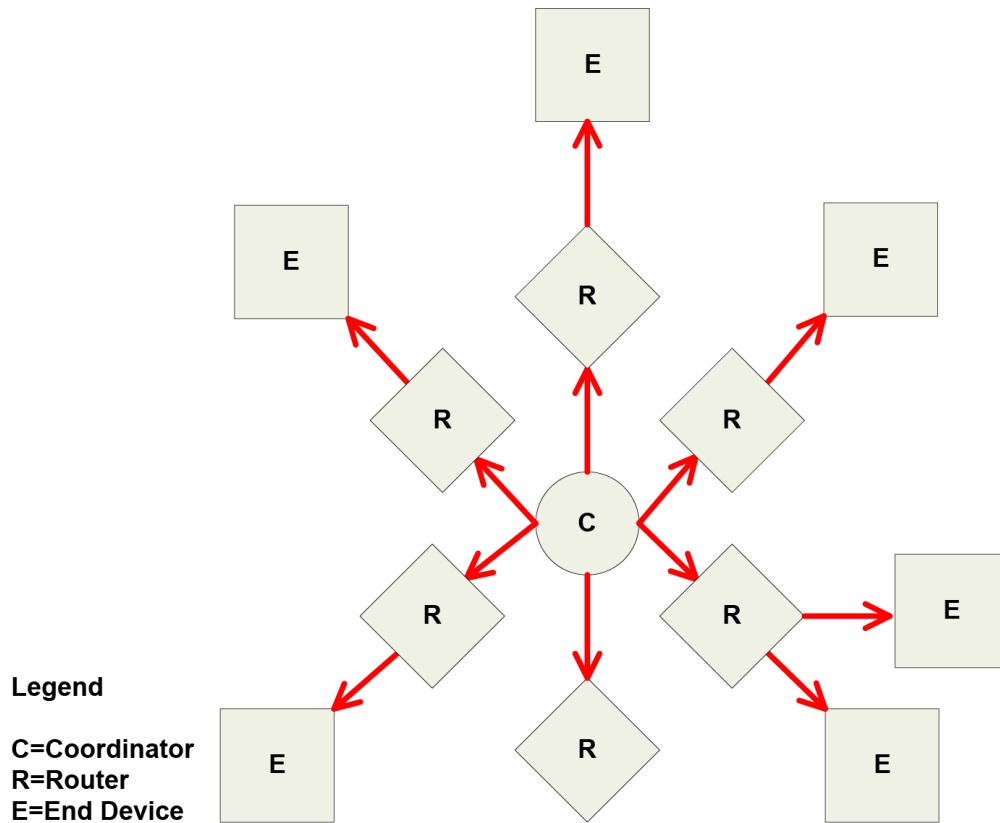

Each node that transmits the broadcast also creates an entry in a local broadcast transmission table. This entry keeps track of each received broadcast packet to ensure the packets are not transmitted endlessly. Each entry persists for 8 seconds, and the broadcast transmission table holds 8 entries.

For each broadcast transmission, the ZigBee stack reserves buffer space for a copy of the data packet that retransmits the packet as needed. Large broadcast packets require more buffer space. Users cannot change any buffer spacing; information on buffer space is for general knowledge only. The XBee device handles buffer spacing automatically.

Since each device in the network retransmits broadcast transmissions, use broadcast messages sparingly.

### Unicast transmissions

Unicast transmissions are sent from one source device to another destination device. The destination device could be an immediate neighbor of the source, or it could be several hops away. Unicast transmissions sent along a multiple hop path require some means of establishing a route to the destination device. For more information, see [RF packet routing](#).

## Address resolution

Each device in a ZigBee network has both a 16-bit (network) address and a 64-bit (extended) address. The 64-bit address is unique and assigned to the device during manufacturing, and the 16-bit address is obtained after joining a network. The 16-bit address can also change under certain conditions.

When sending a unicast transmission, the ZigBee network layer uses the 16-bit address of the destination and each hop to route the data packet. If you do not know the 16-bit address of the destination, the ZigBee stack includes a discovery provision to automatically discover the destination 16-bit address of the device before routing the data.

To discover a 16-bit address of a remote, the device initiating the discovery sends a broadcast address discovery transmission. The address discovery broadcast includes the 64-bit address of the remote device with the 16-bit address being requested. All nodes that receive this transmission check the 64-bit address in the payload and compare it to their own 64-bit address. If the addresses match, the device sends a response packet back to the initiator. This response includes the remote's 16-bit address. When the device receives the discovery response, the initiator transmits the data.

You can address frames using either the extended or the network address. If you use the extended address form, set the network address field to 0xFFFE (unknown). If you use the the network address form, set the extended address field to 0xFFFFFFFFFFFFFFFF (unknown).

If you use an invalid 16-bit address as a destination address, and the 64-bit address is unknown (0xFFFFFFFFFFFFFFFF), the modem status message shows a delivery status code of 0x21 (network ack failure) and a discovery status of 0x00 (no discovery overhead). If you use a non-existent 64-bit address as a destination address, and the 16-bit address is unknown (0xFFFE), the device attempts address discovery and the modem status message shows a delivery status code of 0x24 (address not found) and a discovery status code of 0x01 (address discovery was attempted).

## Address table

Each ZigBee device maintains an address table that maps a 64-bit address to a 16-bit address. When a transmission is addressed to a 64-bit address, the ZigBee stack searches the address table for an entry with a matching 64-bit address to determining the destination's 16-bit address. If the ZigBee stack does not find a known 16-bit address, it performs address discovery to discover the device's current 16-bit address.

64-bit address	16-bit address
0013 A200 4000 0001	0x4414
0013 A200 400A 3568	0x1234
0013 A200 4004 1122	0xC200
0013 A200 4002 1123	0xFFFE (unknown)

For the Smart Energy profiles and related firmware, the XBee modules can store up to 10 address table entries. For the standard firmware versions, the module supports up to 20 address table entries. For applications where a single device (for example, coordinator) sends unicast transmissions to more than 10 devices, the application implements an address table to store the 16-bit and 64-bit addresses for each remote device. Use API mode for any XBee module that sends data to more than 10 remotes. The application can then send both the 16-bit and 64-bit addresses to the XBee in the API transmit frames which significantly reduces the number of 16-bit address discoveries and greatly improves data throughput.

If an application supports an address table, the size should be larger than the maximum number of destination addresses the device communicates with. Each entry in the address table should contain a 64-bit destination address and its last known 16-bit address.

When sending a transmission to a destination 64-bit address, the application searches the address table for a matching 64-bit address. If it finds a match, the application populates the 16-bit address into the 16-bit address field of the API frame. If it does not find a match, set the 16-bit address to 0xFFFFE (unknown) in the API transmit frame. The API provides indication of a remote device's 16-bit address in the following frames:

- All receive data frames
- Rx Data (0x90)
- Rx Explicit Data (0x91)
- I/O Sample Data (0x92)
- Node Identification Indicator (0x95)
- Route Record Indicator (0xA1) and so forth
- Transmit status frame (0x8B)

## Group table

Each router and the coordinator maintain a persistent group table. Each entry contains the following:

- Endpoint value
- Two byte group ID
- Optional name string of zero to 16 ASCII characters
- Index into the binding table

More than one endpoint may be associated with a group ID, and more than one group ID may be associated with a given endpoint. The capacity of the group table is 16 entries.

The application always updates the 16-bit address in the address table when it receives one of the frames to ensure the table has the most recently known 16-bit address. If a transmission failure occurs, the application sets the 16-bit address in the table to 0xFFFFE (unknown).

## Binding transmissions

Binding transmissions use indirect addressing to send one or more messages to other destination devices. The XBee module handles an Explicit Addressing ZigBee Command Frame (0x11) using the Indirect Tx Option (0x04) as a binding transmission request.

### Address resolution

The XBee module use the source endpoint and cluster ID values of a binding transmission as keys to lookup matching binding table entries. For each matching binding table entry, the type field of the entry indicates whether to send a unicast or a multicast message. In the case of a unicast entry, the transmission request is updated with the Destination Endpoint and MAC Address, and unicast to its destination. In the case of a multicast entry, the device updates the message using the two least significant bytes of the Destination MAC Address as the groupID, and multicast to its destinations.

## Binding table

Each router and coordinator maintain a persistent binding table to map source endpoint and cluster ID values into 64 bit destination address and endpoint values. The capacity of the binding table is 16 entries.

## Multicast transmissions

XBee modules use multicast transmissions to broadcast a message to destination devices that have active endpoints associated with a common group ID. The device handles an explicit transmit request frame (0x11) using the Multicast Tx Option (0x08) as a multicast transmission request.

## Address resolution

The 64 bit destination address value does not matter and we recommend that it be set to 0xFFFFFFFFFFFFFFFF. Set the 16 bit destination address value to the destination groupID.

## Fragmentation

Each unicast transmission may support up to 84 bytes of RF payload, although enabling security or using source routing can reduce this number (For more information, see [NP \(Maximum Packet Payload Bytes\)](#)). However, the XBee ZigBee firmware supports a ZigBee feature called fragmentation that allows a single large data packet to be broken up into multiple RF transmissions and reassembled by the receiver before sending data out its serial port.

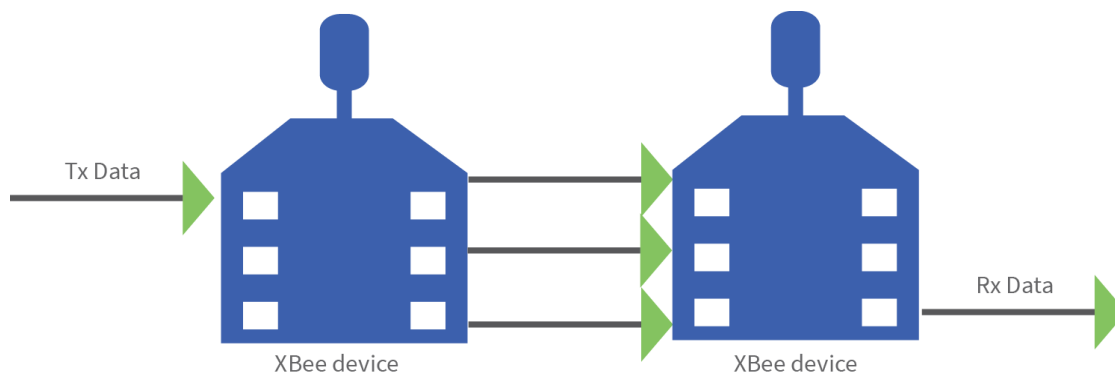

The transmit frame can include up to 255 bytes of data broken up into multiple transmissions and reassembled on the receiving side. If one or more of the fragmented messages are not received by the receiving device, it drops the entire message, and the sender indicates a transmission failure in the Tx Status API frame.

Applications that do not wish to use fragmentation should avoid sending more than the maximum number of bytes in a single RF transmission (see [Maximum RF payload size](#)).

If you enable RTS flow control on the receiving device (using the **D6** command) it receives a fragmented message, it ignores RTS flow control.

---

**Note** Broadcast transmissions do not support fragmentation. Maximum payload size = up to 84 bytes.

---

## Data transmission examples

This section provides examples for data transmission using AT and API firmware.

## AT firmware

To send a data packet in transparent mode, set the **DH** and **DL** commands to match the 64-bit address of the destination device. **DH** must match the upper 4-bytes, and **DL** must match the lower 4 bytes. Since the coordinator always receives a 16-bit address of 0x0000, a 64-bit address of 0x0000000000000000 is the coordinator's address (in ZB firmware). The default values of **DH** and **DL** are 0x00, which sends data to the coordinator.

### Example 1: Send a transmission to the coordinator.

In this example, a '\r' refers to a carriage return character.

A router or end device can send data in two ways. First, set the destination address (**DH** and **DL** commands) to 0x00.

1. Enter command mode ('+++').
2. After receiving an OK\r, issue the following commands:
  - ATDH0\r
  - ATDL0\r
  - ATCN\r
3. Verify that each of the 3 commands returned an OK\r response.
4. After setting these command values, all serial characters are sent as a unicast transmission to the coordinator.

Alternatively, if the coordinator's 64-bit address is known, you can set **DH** and **DL** to the coordinator's 64-bit address. Suppose the coordinator's address is 0x0013A200404A2244.

1. Enter command mode ('+++')
2. After receiving an OK\r, issue the following commands:
  - a. ATDH13A200\r
  - b. ATDL404A2244\r
  - c. ATCN\r
3. Verify that each of the three commands returned an OK\r response.
4. After setting these command values, all serial characters are sent as a unicast transmission to the coordinator.

## API firmware

Use the transmit request, or explicit transmit request frame (0x10 and 0x11 respectively) to send data to the coordinator. The 64-bit address can either be set to 0x0000000000000000, or to the 64-bit address of the coordinator. The 16-bit address should be set to 0xFFFE when using the 64-bit address of all 0x00s.

To send an ASCII "1" to the coordinator's 0x00 address, use the following API frame:

**7E 00 0F 10 01 0000 0000 0000 0000 FFFE 00 00 31 C0**

If you use the explicit transmit frame, set the the cluster ID to 0x0011, the profile ID to 0xC105, and the source and destination endpoints to 0xE8. These are the recommended defaults for data transmissions in the Digi profile.

You can send the same transmission using the following explicit transmit frame:

**7E 00 15 11 01 0000 0000 0000 0000 FFFE E8 E8 0011 C105 00 00 31 18**

The 16-bit address is set to 0xFFFE. This is required when sending to a 64-bit address of 0x00s.

Suppose the coordinator's 64-bit address is 0x0013A200404A2244. The following transmit request API frame (0x10) sends an ASCII "1" to the coordinator:

**7E 00 0F 10 01 0013 A200 404A 2244 0000 0000 31 18**

### Example 2: Send a broadcast transmission

In this example, a '\r' refers to a carriage return character.

Perform the following steps to configure a broadcast transmission:

1. Enter command mode ('+++')
2. After receiving an OK\r, issue the following commands:
  - ATDH0\r b
  - ATDLffff\r
  - ATCN\r 3
3. Verify that each of the three commands returned an OK\r response.
4. After setting these command values, all serial characters are sent as a broadcast transmission.

## API frame

A transmit request API frame (0x10) can send an ASCII "1" in a broadcast transmission using the following API frame:

**7E 00 0F 10 01 0000 0000 0000 FFFF FFFE 00 00 31 C2**

The destination 16-bit address is set to 0xFFFE for broadcast transmissions.

### Example 3: Send an indirect (binding) transmission.

This example uses the explicit transmit request frame (0x11) to send a transmission using indirect addressing through the binding table. It assumes the binding table has already been set up to map a source endpoint of 0xE7 and cluster ID of 0x0011 to a destination endpoint and 64 bit destination address. The message data is a manufacturing specific profile message using profile ID 0xC105, command ID 0x00, a ZCL Header of 151E10, transaction number EE, and a ZCL payload of 000102030405:

**7E 001E 11 e4 FFFFFFFFFFFFFFFF FFFE E7 FF 0011 C105 00 04 151E10EE000102030405 14**

---

**Note** The 64 bit destination address has been set to all 0xFF values, and the destination endpoint set to 0xFF. The Tx Option 0x04 indicates indirect addressing. The 64 bit destination address and destination endpoint are completed by looking up data associated with binding table entries. This matches the following example.

---

### Example 4: Send a multicast (group ID) broadcast.

This example uses the explicit transmit request frame (0x11) to send a transmission using multicasting. It assumes the destination devices already have their group tables set up to associate an active endpoint with the group ID (0x1234) of the multicast transmission. The message data is a manufacturing specific profile message using profile ID 0xC105, command ID 0x00, a ZCL Header of 151E10, transaction number EE, and a ZCL payload of 000102030405:

**7E 001E 11 01 FFFFFFFFFFFFFFFF 1234 E6 FE 0001 C105 00 08 151E10EE000102030405 BC**



**Note** The 64 bit destination address has been set to all 0xFF values, and the destination endpoint set to 0xFE. The Tx Option 0x08 indicates use of multicast (group) addressing.

## RF packet routing

Unicast transmissions may require some type of routing. ZigBee includes several different methods to route data, each with its own advantages and disadvantages as summarized in the following table.

Routing Approach	Description	When to Use
Ad hoc On-demand Distance Vector (AODV) Mesh Routing	Routing paths are created between source and destination, possibly traversing multiple nodes (“hops”). Each device knows where to send data next to eventually reach the destination.	Use in networks that will not scale beyond about 40 destination devices.
Many-to-One Routing	A single broadcast transmission configures reverse routes on all devices into the device that sends the broadcast.	Useful when many remote devices must send data to a single gateway or collector device.
Source Routing	Data packets include the entire route the packet should traverse to get from source to destination.	Improves routing efficiency in large networks (over 40 remote devices).

**Note** End devices do not make use of these routing protocols. Rather, an end device sends a unicast transmission to its parent and allows the parent to route the data packet in its behalf.

**Note** To revert from Many-to-One routing to AODV routing, a network must first do a network reset (NR).

## Link status transmission

Before discussing the various routing protocols, it is worth understanding the primary mechanism in ZigBee for establishing reliable bi-directional links. This mechanism is especially useful in networks that may have a mixture of devices with varying output power and/or receiver sensitivity levels.

Each coordinator or router device periodically sends a link status message as a 1-hop broadcast transmission, received only by one-hop neighbors. The link status message contains a list of neighboring devices and incoming and outgoing link qualities for each neighbor. Using these messages, neighboring devices determines the quality of a bi-directional link with each neighbor and uses that information to select a route that works well in both directions.

For example, consider a network of two neighboring devices that send periodic link status messages. Suppose that the output power of device A is +18 dBm, and the output power of device B is +3 dBm (considerably less than the output power of device A). The link status messages might indicate the following:

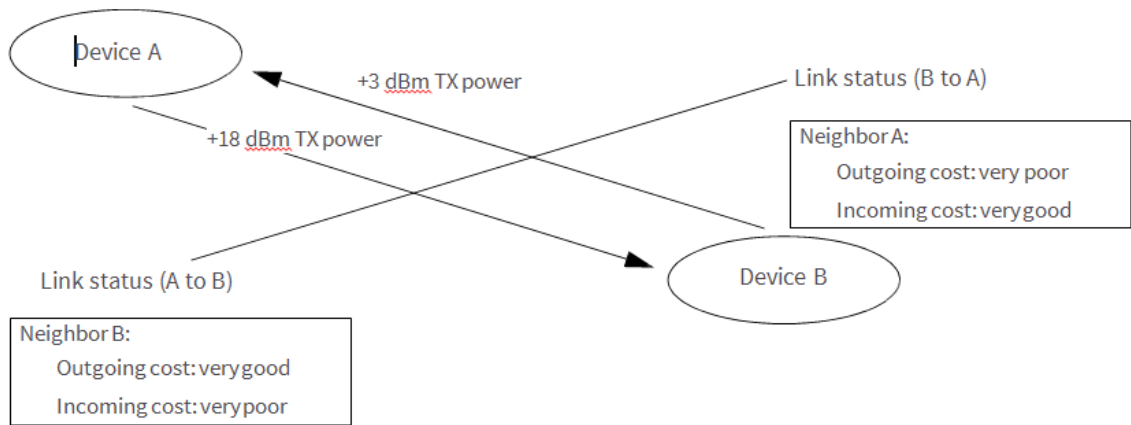

This mechanism enables devices A and B to recognize that the link is not reliable in both directions and select a different neighbor when establishing routes. Such links are called asymmetric links, meaning the link quality is not similar in both directions.

When a router or coordinator device powers on, it sends link status messages every couple seconds to attempt to discover link qualities with its neighbors quickly. After being powered on for some time, the link status messages are sent at a much slower rate, about every 3-4 times per minute.

### AODV mesh routing

ZigBee employs mesh routing to establish a route between the source device and the destination. Mesh routing allows data packets to traverse multiple nodes (hops) in a network to route data from a source to a destination. Routers and coordinators can participate in establishing routes between source and destination devices using a process called route discovery. The Route discovery process is based on the Ad-hoc On-demand Distance Vector routing (AODV) protocol.

Sample transmission through a mesh network:

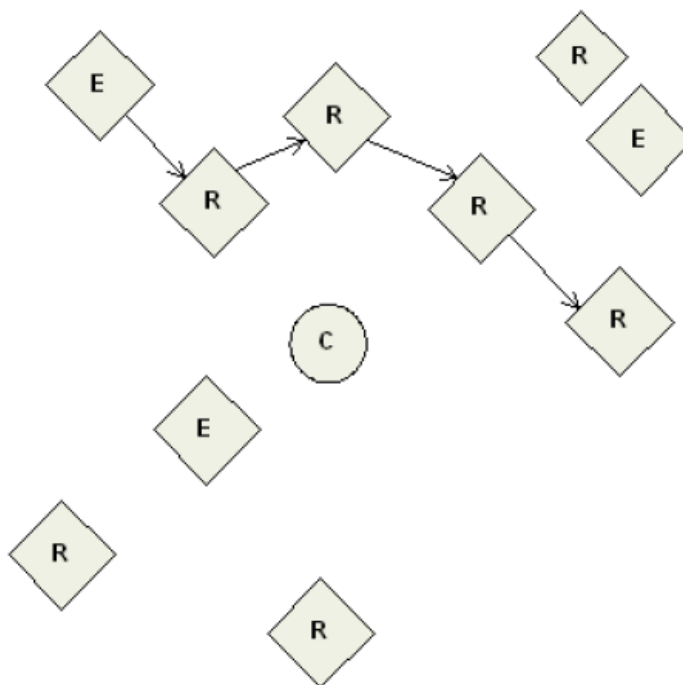

**AODV routing algorithm**

Routing under the AODV protocol uses tables in each node that store the next hop (intermediary node between source and destination nodes) for a destination node. If a next hop is unknown, route discovery takes place to find a path. Since only a limited number of routes can be stored on a router, route discovery takes place more often on a large network with communication between many different nodes.

Node	Destination address	Next hop address
R3	Router 6	Coordinator
C	Router 6	Router 5
R5	Router 6	Router 6

When a source node discovers a route to a destination node, it sends a broadcast route request command. The route request command contains the source network address, the destination network address and a path cost field (a metric for measuring route quality). As the route request command propagates through the network (refer to [Broadcast transmissions](#)), each node that re-broadcasts the message updates the path cost field and creates a temporary entry in its route discovery table.

The following graphic is a sample route request (broadcast) transmission where R3 is trying to discover a route to R6:

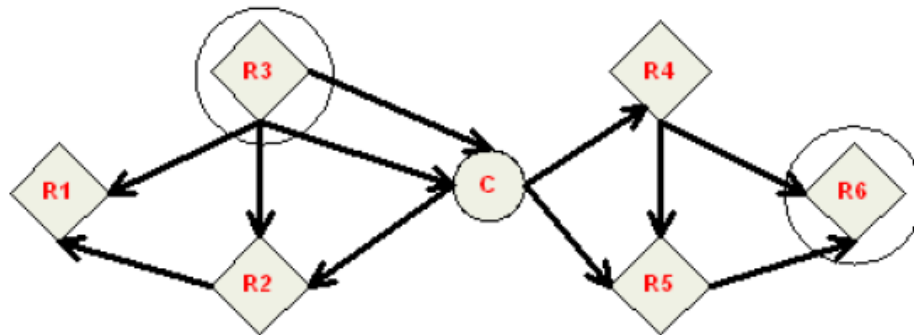

When the destination node receives a route request, it compares the 'path cost' field against previously received route request commands. If the path cost stored in the route request is better than any previously received, the destination node transmits a route reply packet to the node that originated the route request. Intermediate nodes receive and forward the route reply packet to the source node (the node that originated route request).

The following graphic is a sample route reply (unicast) where R6 sends a route reply to R3:

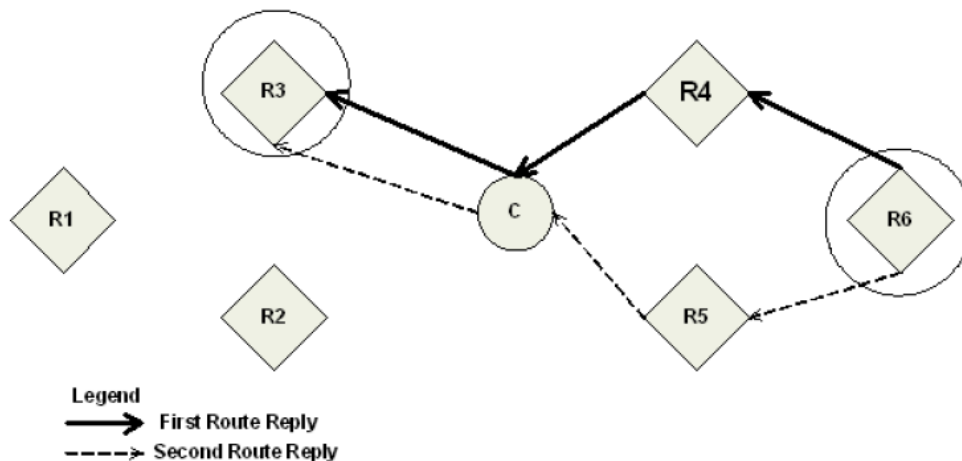

---

**Note** R6 could send multiple replies if it identifies a better route.

---

### **Retries and acknowledgments**

ZigBee includes acknowledgment packets at both the Mac and Application Support (APS) layers. When data is transmitted to a remote device, it may traverse multiple hops to reach the destination. As the device transmits data from one node to its neighbor, it transmits an acknowledgment packet (Ack) in the opposite direction to indicate that the transmission was successfully received. If the Ack is not received, the transmitting device retransmits the data, up to 4 times.

This Ack is called the Mac layer acknowledgment. In addition, the device that originated the transmission expects to receive an acknowledgment packet (Ack) from the destination device. This Ack traverses the same path the data traversed, but in the opposite direction. If the originator fails to

receive this Ack, it retransmits the data, up to 2 times until it receives an Ack. This Ack is called the ZigBee APS layer acknowledgment.

---

**Note** Refer to the ZigBee specification for more details.

---

## Many-to-One routing

In networks where many devices must send data to a central collector or gateway device, AODV mesh routing requires significant overhead. If every device in the network had to discover a route before it could send data to the data collector, the network could easily become inundated with broadcast route discovery messages.

Many-to-one routing is an optimization for these kinds of networks. Rather than require each device to do its own route discovery, the device sends a single many-to-one broadcast transmission from the data collector to establish reverse routes on all devices.

The many-to-one broadcast is a route request message with the target discovery address set to the address of the data collector. Devices that receive this route request create a reverse many-to-one routing table entry to create a path back to the data collector. The ZigBee stack on a device uses historical link quality information about each neighbor to select a reliable neighbor for the reverse route.

When a device sends data to a data collector, and it finds a many-to-one route in its routing table, it transmits the data without performing a route discovery. Send the many-to-one route request periodically to update and refresh the reverse routes in the network.

Applications that require multiple data collectors can also use many-to-one routing. If more than one data collector device sends a many-to-one broadcast, devices create one reverse routing table entry for each collector.

The ZB firmware uses the **AR** command to enable many-to-one broadcasting on a device. The **AR** command sets a time interval (measured in 10 second units) for sending the many to one broadcast transmission. (See the command table for details).

## High/Low RAM Concentrator mode

When Many to One (MTO) requests are broadcast, DO40 (bit6) determines if the concentrator is operating in high or low RAM mode. High RAM mode indicates the concentrator has enough memory to store source routes for the whole network, and remote nodes may stop sending route records after the concentrator has successfully received one. Low RAM mode indicates the concentrator lacks RAM to store route records, and that route records be sent to the concentrator to precede every inbound APS unicast message. By default the device uses low RAM mode.

## Source routing

In applications where a device must transmit data to many remotes, AODV routing requires performing one route discovery for each destination device to establish a route. If there are more destination devices than there are routing table entries, new routes overwrite established AODV routes, causing route discoveries to occur more regularly. This can result in larger packet delays and poor network performance.

ZigBee source routing helps solve these problems. In contrast to many-to-one routing that establishes routing paths from many devices to one data collector, source routing allows the collector to store and specify routes for many remotes.

To use source routing, a device must use the API mode, and it must send periodic many-to-one route request broadcasts (AR command) to create a many-to-one route to it on all devices. When remote devices send RF data using a many-to-one route, they first send a route record transmission. The

route record transmission is unicast along the many-to-one route until it reaches the data collector. As the route record traverses the many-to-one route, it appends the 16-bit address of each device in the route into the RF payload. When the route record reaches the data collector, it contains the address of the sender, and the 16-bit address of each hop in the route. The data collector can store the routing information and retrieve it later to send a source routed packet to the remote as shown in the following images.

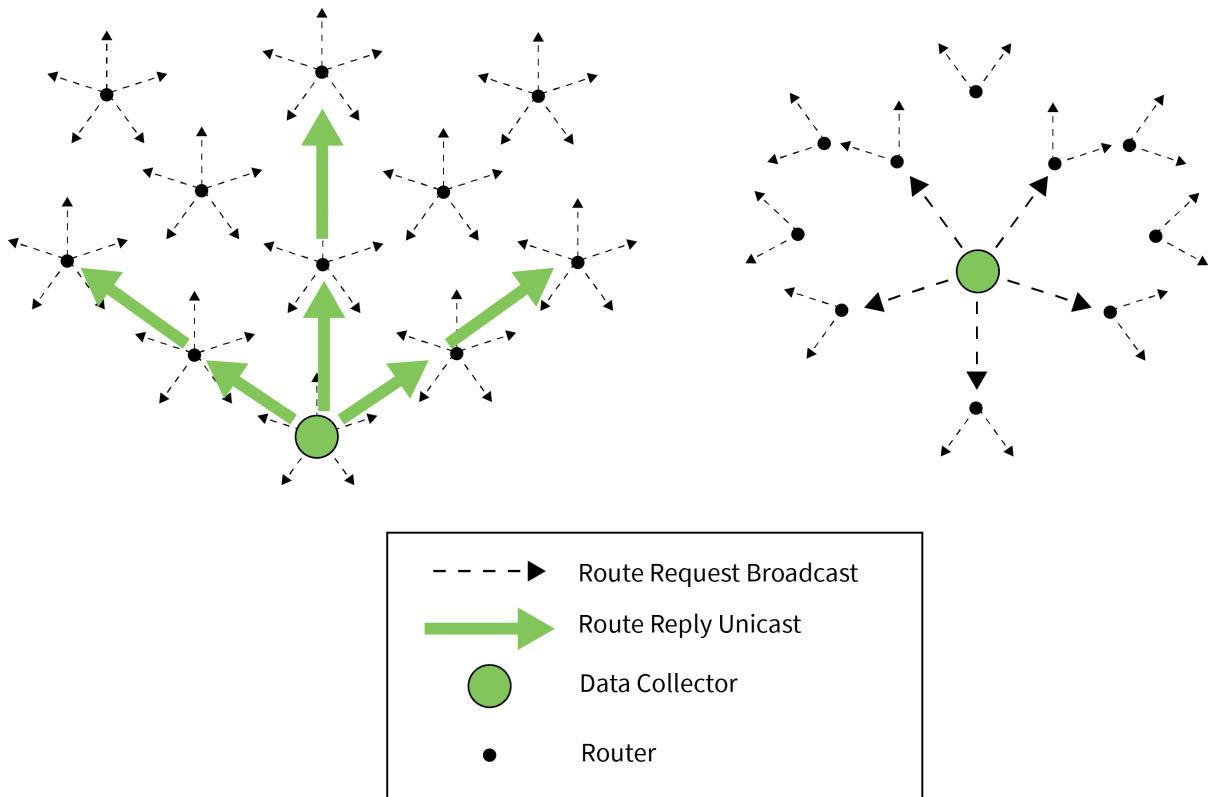

The data collector sends a many-to-one route request broadcast to create reverse routes on all devices.

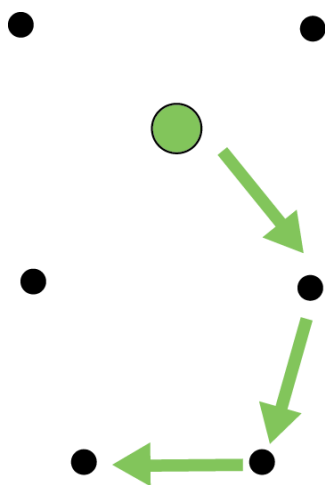

A remote device sends an RF data packet to the data collector. This is prefaced by a route record transmission to the data collector.

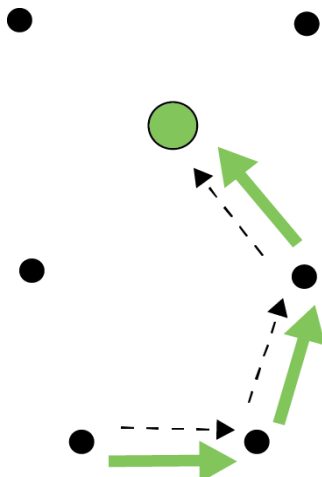

After obtaining a source route, the data collector sends a source routed transmission to the remote device.

### Acquiring source routes

Acquiring source routes requires the remote devices to send a unicast to a data collector (device that sends many-to-one route request broadcasts). There are several ways to force remotes to send route record transmissions.

1. If the application on remote devices periodically sends data to the data collector, each transmission force a route record to occur.
2. The data collector can issue a network discovery command (**ND** command) to force all XBee modules to send a network discovery response. A route record prefaces each network discovery response.
3. You can enable periodic I/O sampling on remotes to force them to send data at a regular rate. A route record prefaces each I/O sample. For more information, see [Analog and digital I/O lines](#).
4. If the **NI** string of the remote device is known, the **DN** command can be issued with the NI string of the remote in the payload. The remote device with a matching NI string would send a route record and a DN response.

### Storing source routes

When a data collector receives a route record, it sends it out the serial port as a Route Record Indicator API frame (0xA1). To use source routing, the application receives these frames and stores the source route information.

### Sending a source routed transmission

To send a source routed transmission, the application must send a Create Source Route API frame (0x21) to the XBee to create a source route in its internal source route table. After sending the Create Source Route API frame, the application can send data transmission or remote command request frames as needed to the same destination, or any destination in the source route. Once data must be sent to a new destination (a destination not included in the last source route), the application must first send a new Create Source Route API frame.

**Note** If a Create Source Route API frame does not precede data frames, you may encounter data loss.

The XBee module can buffer one source route that includes up to 11 hops (excluding source and destination). For example, suppose a network exists with a coordinator and 5 routers (R1, R2, R3, R4, R5) with known source routes as shown in the following image.

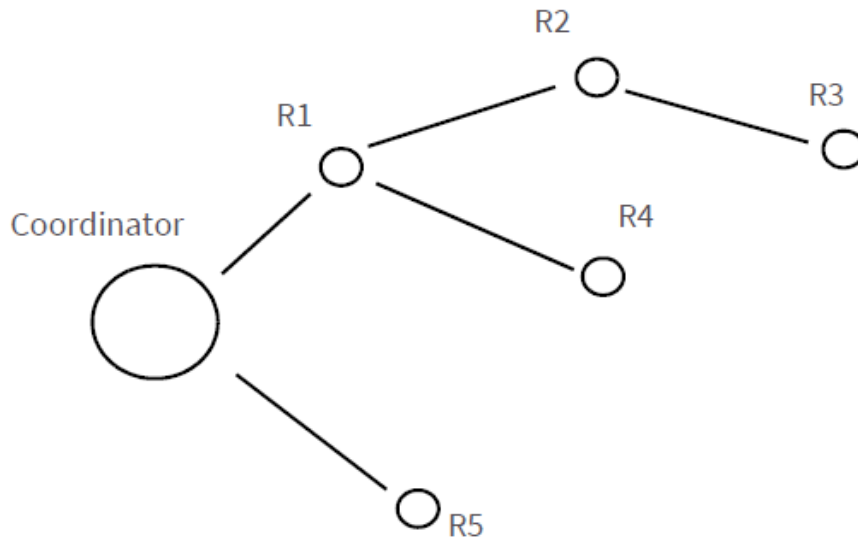

To send a source-routed packet to R3, the application sends a Create Source Route API frame (0x21) to the XBee, with a destination of R3, and 2 hops (R1 and R2). If the 64-bit address of R3 is 0x0013A200 404a1234 and the 16-bit addresses of R1, R2, and R3 are:

Device	16-bit address
R1	0xAABB
R2	0xCCDD
R3	0xEEFF

The Create Source Route API frame would be:

7E 0012 21 00 0013A200 404A1234 EEFF 00 02 CCDD AABB 5C

**Field composition**

0x0012	length
0x21	API ID (create source route)
0x00	frame ID (set to 0 always)
0x0013A200 404A1234	64-bit address of R3 (destination)
0xEEFF	16-bit address of R3 (destination)



0x00	Route options (set to 0)
0x02	Number of intermediate devices in the source route
0xCCDD	Address of furthest device (1-hop from target)
0xAABB	Address of next-closer device
0x5C	Checksum (0xFF - SUM (all bytes after length))

### **Repairing source routes**

It is possible for a network to have an existing source route fail (for example, a device in the route moves or goes down). If a device goes down in a source routed network, all routes that used the device will be broken.

As mentioned previously, source routing must be used with many-to-one routing. A device that uses source routing must also send a periodic many-to-one broadcast in order to keep routes fresh. If a source route breaks, remote devices send in new route record transmissions to the data collector to provide it with a new source route. This requires that remote devices periodically send data transmissions into the data collector. For more information, see [Acquiring source routes](#).

### **Retries and acknowledgments**

ZigBee includes acknowledgment packets at both the Mac and Application Support (APS) layers. When data transmits to a remote device, it may traverse multiple hops to reach the destination. As data transmits from one node to its neighbor, an acknowledgment packet (Ack) transmits in the opposite direction to indicate that the transmission was successfully received. If the transmitting device does not receive the Ack, it retransmits the data up to 4 times. This Ack is called the Mac layer acknowledgment.

In addition, the device that originated the transmission expects to receive an acknowledgment packet (Ack) from the destination device. This Ack traverses the same path that the data traversed, but in the opposite direction. If the originator fails to receive this Ack, it retransmits the data, up to two times until an Ack is received. This Ack is called the ZigBee APS layer acknowledgment.

---

**Note** Refer to the ZigBee specification for more details.

---

### **Disabling MTO routing**

To disable MTO (many-to-one) routing in a network, first reconfigure the **AR** setting on the aggregator and then broadcast a network wide power reset (0x08 of the **RE** command) to rebuild the routing tables.

1. Set **AR** on the aggregator to 0xFF.
2. Complete an **AC** command to enact the change.
3. Complete a **WR** command if the saved configuration setting value for **AR** is not 0xFF.

This ends the periodic broadcast of aggregator messages if the previous setting was 0x01-0xFE, and prevents a single broadcast after a power reset if the previous setting was 0x00. Broadcast a **FR** remote command to the network and wait for the network to reform. This removes the aggregator's status as an aggregator from the network's routing tables so that no more route records will be sent to the aggregator.

### Disabling route records

If an aggregator collects route records from the nodes of the network and no longer needs route records sent (which consume network throughput) :

1. Set Bit 6 of **DO** to Enable High RAM Concentrator mode. High RAM mode means the aggregator has sufficient memory to hold route records for its potential destinations.
2. Set **AR** to 0x00 for a one-time broadcast (which some nodes might miss), or a value in the range of 0x01 to 0xFE (in units of 10 seconds) to periodically send a broadcast to inform the network that the aggregator is operating in High RAM Concentrator mode and no longer needs to receive route records.
3. Use Create Source Route (API frame type 0x21) to load the route record for a destination into the local XBee's source route table.
4. Send a unicast to the destination. The route record embeds in the payload and determines the sequence of routers to use in transmitting the unicast to the destination. After receiving the unicast, the destination no longer sends route records to the aggregator, now that it has confirmed the High RAM Concentrator aggregator 'knows' its route record.

### Clearing the source route table

To clear the source route table, change the **AR** setting from a non-0xFF setting to 0xFF and complete an **AC** command. To re-establish periodic aggregator broadcasts, change the **AR** setting to a non-0xFF setting and complete an **AC** command.

## Encrypted transmissions

Encrypted transmissions are routed similar to non-encrypted transmissions with one exception. As an encrypted packet propagates from one device to another, each device decrypts the packet using the network key and authenticates the packet by verifying packet integrity. It then re-encrypts the packet with its own source address and frame counter values and sends the message to the next hop. This process adds some overhead latency to unicast transmissions, but it helps prevent replay attacks. For more information see [ZigBee security](#).

## Maximum RF payload size

The **NP** command returns the maximum payload size in bytes. The actual maximum payload is a function of the following:

- message type (broadcast or unicast)
- AP setting
- APS encryption option
- source-routing

Broadcasts, which cannot be encrypted with APS or fragmented have a maximum payload of 0x54 bytes. Unicasts where **AP** is 0 also have a maximum payload of 0x54 bytes. A non-zero **AP** means **NP** will be 0xFF or 255 bytes.

For broadcast messages and unicast messages when AP==0, the maximum payload is 0x54 bytes.

For unicast messages when **AP** is nonzero (API mode) the maximum payload is 0xFF (255 decimal) bytes. If the combination of payload and optional APS encryption overhead (EE1, TxOption 0x20) is too

high, the message fragments into a maximum of five fragments. The firmware encrypts and transmits each fragment separately. The destination radio reassembles the fragments into a full message.

For Smart Energy firmware revision 5x32 and earlier, NP==0x80. As of 5x56, NP==0xFF.

The maximum payload is complicated to estimate for aggregator source-routing. To reduce the maximum payload, when an aggregator sends a source-routed message it embeds the route into the message as overhead, or into each fragment of the message, if fragmentation is necessary. If you use APS encryption (EE1, Tx Option 0x20), it reduces the number further.

The route overhead is 2 bytes plus 2 bytes per hop. The bytes are:

- one byte is the number of hops
- one byte is an index into the route list that increments in value at each hop
- other data is a list of the 16-bit network addresses of the routing radios

Firmware revisions before 4x58 support a maximum of 11 aggregator source-routed hops. Firmware revisions 4x58 and following support a maximum of 25 aggregator source-routed hops.

Aggregator source-routed payload maximums do not apply to messages that are sourced by non-aggregator nodes, which send route records ahead of their messages to aggregators. Aggregators are either Coordinators or Routers which have the following:

- source routing enabled or
- **AR** setting which is not 0xFF

The following table shows the aggregator source-routed payload maximums as a function of hops and APS encryption:

Hops	Maximum encrypted payload	Maximum unencrypted payload
1	255	255
2	255	255
3	255	255
4	255	255
5	255	255
6	215	255
7	205	250
8	195	240
9	185	230
10	175	220
11	165	210
12	155	200
13	145	190
14	135	180
15	125	170

Hops	Maximum encrypted payload	Maximum unencrypted payload
16	115	160
17	105	150
18	95	140
19	85	130
20	75	120
21	65	110
22	55	100
23	45	90
24	35	80
25	25	70

## Throughput

Throughput in a ZigBee network can differ by a number of variables, including:

- number of hops
- encryption enabled/disabled
- sleeping end devices
- failures/route discoveries.

Our empirical testing showed the following throughput performance in a robust operating environment (low interference).

Configuration	Data throughput
1 hop, <b>RR, SD</b>	58 kb/s
1 hop, <b>RR, SE</b>	34 kb/s
1 hop, <b>RE, SD</b>	Not yet available
1 hop, <b>RR, SE</b>	Not yet available
1 hop, <b>ER, SD</b>	Not yet available
1 hop, <b>ER, SE</b>	Not yet available
4 hops, <b>RR, SD</b>	Not yet available
4 hops, <b>RR, SE</b>	Not yet available
<b>RR</b> = router to router <b>RE</b> = router to end device (non-sleeping) <b>ER</b> = end device (non-sleeping) to router <b>SD</b> = security disabled <b>SE</b> = security enabled 4 hops = 5 nodes total, 3 intermediate router nodes	

**Note** We set the serial interface rate to 115200 b/s for data throughput measurements, and measured the time to send 100,000 bytes from source to destination. During the test, no route discoveries or failures occurred.

## ZDO transmissions

ZigBee defines a ZigBee Device Objects layer (ZDO) that provides device and service discovery and network management capabilities.

### ZDO

Cluster name	Cluster ID	Description
Network Address Request	0x0000	Request a 16-bit address of the radio with a matching 64-bit address (required parameter).
Active Endpoints Request	0x0005	Request a list of endpoints from a remote device.
LQI Request	0x0031	Request data from a neighbor table of a remote device.
Routing Table Request	0x0032	Request to retrieve routing table entries from a remote device.
Network Address Response	0x8000	Response that includes the 16-bit address of a device.
LQI Response	0x8031	Response that includes neighbor table data from a remote device.
Routing Table Response	0x8032	Response that includes routing table entry data from a remote device.

Refer to the ZigBee specification for a detailed description of all ZigBee Device Profile services.

### Sending a ZDO command

You must use an explicit transmit API frame to send a ZDO command, and it must be formatted correctly. Set the source and destination endpoints and profile ID to 0. Set the cluster ID to match the cluster ID of the appropriate service. For example, to send an active endpoints request, set the cluster ID to 0x0005.

The first byte of payload in the API frame is an application sequence number (transaction sequence number) that can be set to any single byte value. The first byte of the ZDO response uses this same value. All remaining payload bytes must be set as required by the ZDO. All multi-byte values must be sent in little endian byte order.

### Receiving ZDO command and responses

In XBee ZB firmware, you can easily send ZDO commands using the API. To receive incoming ZDO commands, enable receiver application addressing with the **AO** command. See the examples later in this section. Not all incoming ZDO commands are passed up to the application.

When a ZDO message is received on endpoint 0 and profile ID 0, the cluster ID indicates the type of ZDO message received. The first byte of payload is generally a sequence number that corresponds to

a sequence number of a request. The remaining bytes are set as defined by the ZDO. Similar to a ZDO request, all multi-byte values in the response are in little endian byte order.

### **Example 1: Send a ZDO LQI request to read the neighbor table contents of a remote**

Looking at the ZigBee specification, the cluster ID for an LQI Request is 0x0031, and the payload only requires a single byte (start index). This example sends an LQI request to a remote device with a 64-bit address of 0x0013A200 40401234. The start index is set to 0, and the transaction sequence number is set to 0x76.

#### **API Frame**

```
7E 0016 11 01 0013A200 40401234 FFFE 00 00 0031 0000 00 00 76 00 CE
```

#### **Field composition**

0x0016	length
0x11	Explicit transmit request
0x01	Frame ID (set to a non-zero value to enable the transmit status message, or set to 0 to disable)
0x0013A200 40401234	64-bit address of the remote
0xFFFFE	16-bit address of the remote (0xFFFFE = unknown). Optionally, set to the 16-bit address of the destination if known.
0x00	Source endpoint
0x00	Destination endpoint
0x0031	Cluster ID (LQI Request, or Neighbor table request)
0x0000	Profile ID (ZigBee Device Profile)
0x00	Broadcast radius
0x00	Tx Options
0x76	Transaction sequence number
0x00	Required payload for LQI request command
0xCE	Checksum (0xFF - SUM (all bytes after length))

#### **Description**

This API frame sends a ZDO LQI request (neighbor table request) to a remote device to obtain data from its neighbor table. You must set the **AO** command correctly on an API device to enable the explicit API receive frames to receive the ZDO response.

### **Example 2: Send a ZDO network Address Request to discover the 16-bit address of a remote**

Looking at the ZigBee specification, the cluster ID for a network Address Request is 0x0000, and the payload only requires the following:

[64-bit address] + [Request Type] + [Start Index]

This example sends a Network Address Request as a broadcast transmission to discover the 16-bit address of the device with a 64-bit address of 0x0013A200 40401234. The request type and start index are set to 0, and the transaction sequence number is set to 0x44.

#### API frame

```
7E 001F 11 01 00000000 0000FFFF FFFE 00 00 0000 0000 00 00 44 34124040 00A21300 00 00 33
```

#### Field composition

0x001F	length
0x11	Explicit transmit request
0x01	Frame ID (set to a non-zero value to enable the transmit status message, or set to 0 to disable)
0x00000000 0000FFFF	64-bit address for a broadcast transmission
0xFFFFE	Set to this value for a broadcast transmission
0x00	Source endpoint
0x00	Destination endpoint
0x0000	Cluster ID (Network Address Request)
0x0000	Profile ID (ZigBee Device Profile)
0x00	Broadcast radius
0x00	Tx Options
0x44	Transaction sequence number
0x34124040 00A21300 00 00	Required payload for Network Address Request command
0x33	Checksum (0xFF - SUM (all bytes after length))

#### Description

This API frame sends a broadcast ZDO Network Address Request to obtain the 16-bit address of a device with a 64-bit address of 0x0013A200 40401234. We inserted the bytes for the 64-bit address in little endian byte order. You must insert data for all multi-byte fields in the API payload of a ZDO command in little endian byte order. You must set the **AO** command correctly on an API device to enable the explicit API receive frames to receive the ZDO response.

## Transmission timeouts

The ZigBee stack includes two kinds of transmission timeouts, depending on the nature of the destination device. Destination devices such as routers with receivers always on use a unicast timeout. The unicast timeout estimates a timeout based on the number of unicast hops the packet should traverse to get data to the destination device. For transmissions destined for end devices, the ZigBee stack uses an extended timeout that includes the unicast timeout (to route data to the end device's parent), and it includes a timeout for the end device to finish sleeping, wake, and poll the parent for data.

The ZigBee stack includes some provisions for a device to detect if the destination is an end device. The ZigBee stack uses the unicast timeout unless it knows the destination is an end device.

The XBee API includes a transmit options bit that you can set to specify the extended timeout used for a given transmission. If you set this bit, the extended timeout will be used when sending RF data to the specified destination. To improve routing reliability, applications set the extended timeout bit when sending data to end devices if:

- The application sends data to 10 or more remote devices, some of which are end devices.
- The end devices may sleep longer than the unicast timeout.

Equations for these timeouts are computed in the following sections.

---

**Note** The timeouts in this section are worst-case timeouts and should be padded by a few hundred milliseconds. These worst-case timeouts apply when an existing route breaks down (for example, intermediate hop or destination device moved).

---

## Unicast timeout

Set the unicast timeout with the **NH** command. The actual unicast timeout is computed as  $((50 * NH) + 100)$ . The default **NH** value is 30 which equates to a 1.6 second timeout.

The unicast timeout includes 3 transmission attempts (1 attempt and 2 retries).

The maximum total timeout is approximately:

$$3 * ((50 * NH) + 100)$$

For example, if **NH**=30 (0x1E), the unicast timeout is approximately  $3 * ((50 * 30) + 100)$  or one of the following:

- $3 * (1500 + 100)$
- $3 * (1600)$
- 4800 ms
- 4.8 seconds

## Extended timeout

The worst-case transmission timeout when you are sending data to an end device is a larger issue than when transmitting to a router or coordinator. As described in [Parent operation](#), RF data packets are sent to the parent of the end device, which buffers the packet until the end device wakes to receive it. The parent buffers an RF data packet for up to  $(1.2 * SP)$  time.

To ensure the end device has adequate time to wake and receive the data, the extended transmission timeout to an end device is:

$$(50 * NH) + (1.2 * SP)$$

This timeout includes the packet buffering timeout  $(1.2 * SP)$  and time to account for routing through the mesh network  $(50 * NH)$ .

If no acknowledgment is received within this time, the sender resends the transmission up to two more times. With retries included, the longest transmission timeout when sending data to an end device is:

$$3 * ((50 * NH) + (1.2 * SP))$$

The **SP** value in both equations must be entered in millisecond units. The **SP** command setting uses 10 ms units and must be converted to milliseconds to be used in this equation.



For example, suppose a router is configured with **NH**=30 (0x1E) and **SP**=0x3E8 (10,000 ms), and that it is either trying to send data to one of its end device children, or to a remote end device. The total extended timeout to the end device is approximately:

$3 * ((50 * \mathbf{NH}) + (1.2 * \mathbf{SP}))$  or one of the following:

- $3 * (1500 + 12000)$
- $3 * (13500)$
- 40500 ms
- 40.5 seconds

## Transmission examples

Example 1: Send a unicast API data transmission to the coordinator using 64-bit address 0, with payload “TxData”.

### API frame

```
7E 0014 10 01 00000000 00000000 FFFE 00 00 54 78 44 61 74 61 AB
```

### Field composition

0x0014	length
0x10	API ID (TX data)
0x01	Frame ID (set greater than 0 to enable the TX-status response)
0x00000000 00000000	64-bit address of coordinator (ZB definition)
0xFFFFE	Required 16-bit address if sending data to 64-bit address of 0
0x00	Broadcast radius (0 = max hops)
0x00	Tx options
0x54 78 44 61 74 61	ASCII representation of “TxData” string
0xAB	Checksum (0xFF - SUM (all bytes after length))

### Description

This transmission sends the string “TxData” to the coordinator, without knowing the 64-bit address of the coordinator device. ZB firmware defines a 64-bit address of 0 as the coordinator. If the coordinator's 64-bit address was known, the 64-bit address of 0 could be replaced with the coordinator's 64-bit address, and the 16-bit address could be set to 0.

Example 2: Send a broadcast API data transmission that all devices can receive (including sleeping end devices), with payload “TxData”

### API frame

```
7E 0014 10 01 00000000 0000FFFF FFFE 00 00 54 78 44 61 74 61 AD
```

**Field composition**

0x0014	length
0x10	API ID (TX data)
0x01	Frame ID (set to a non-zero value to enable the TX-status response)
0x00000000 0000FFFF	Broadcast definition (including sleeping end devices)
0xFFFFE	Required 16-bit address to send broadcast transmission
0x00	Broadcast radius (0 = max hops)
0x00	Tx options
0x54 78 44 61 74 61	ASCII representation of “TxData” string
0xAD	Checksum (0xFF - SUM (all bytes after length))

**Description**

This transmission sends the string “TxData” as a broadcast transmission. Since the destination address is set to 0xFFFF, all devices, including sleeping end devices can receive this broadcast.

If receiver application addressing is enabled, the XBee reports all received data frames in the explicit format (0x91) to indicate the source and destination endpoints, cluster ID, and profile ID where each packet was received. Status messages like modem status and route record indicators are not affected.

To enable receiver application addressing, set the **AO** command to 1 using the AT command frame (0x08) as follows:

**API frame**

```
7E 0005 08 01 414F 01 65
```

**Field composition**

0x0005	length
0x08	API ID (AT command)
0x01	Frame ID (set to a non-zero value to enable AT command response frames)
0x414F	ASCII representation of 'A','O' (the command being issued)
0x01	Parameter value
0x65	Checksum (0xFF - SUM (all bytes after length))

**Description**

Setting **AO=1** is required for the XBee device to use the explicit receive API frame (0x91) when receiving RF data packets. This is required if the application needs indication of source or destination endpoint, cluster ID, or profile ID values used in received ZigBee data packets. ZDO messages can only be received if **AO=1**.

## ZigBee security

---

ZigBee supports various levels of security that you can configure depending on the needs of the application. Security provisions include:

- 128-bit AES encryption
- Two security keys that can be preconfigured or obtained during joining
- Support for a trust center
- Provisions to ensure message integrity, confidentiality, and authentication

This section describes various security features defined in the ZigBee specification and illustrates how you can configure the XBee modules to support these features.

Security modes .....	100
ZigBee security model .....	100
Implementing security on the XBee .....	103

## Security modes

The ZigBee standard supports three security modes: residential, standard, and high security.

- **Residential security** requires a network key be shared among devices.
- **Standard security** adds a number of optional security enhancements over residential security, including an APS layer link key.
- **High security** adds entity authentication and a number of other features not widely supported.

XBee ZB modules primarily support standard security, although end devices that support residential security can join and interoperate with standard security devices. This section focuses on material that is relevant to standard security.

## ZigBee security model

ZigBee security is applied to the Network and APS layers. Packets are encrypted with 128-bit AES encryption. A network key and optional link key can be used to encrypt data. Only devices with the same keys are able to communicate together in a network. Routers and end devices that will communicate on a secure network must obtain the correct security keys.

### Network layer security

The network key is used to encrypt the APS layer and application data. In addition to encrypting application messages, network security is also applied to route request and reply messages, APS commands, and ZDO commands. Network encryption is not applied to MAC layer transmissions such as beacon transmissions. If you enable security on a network, all data packets are encrypted with the network key.

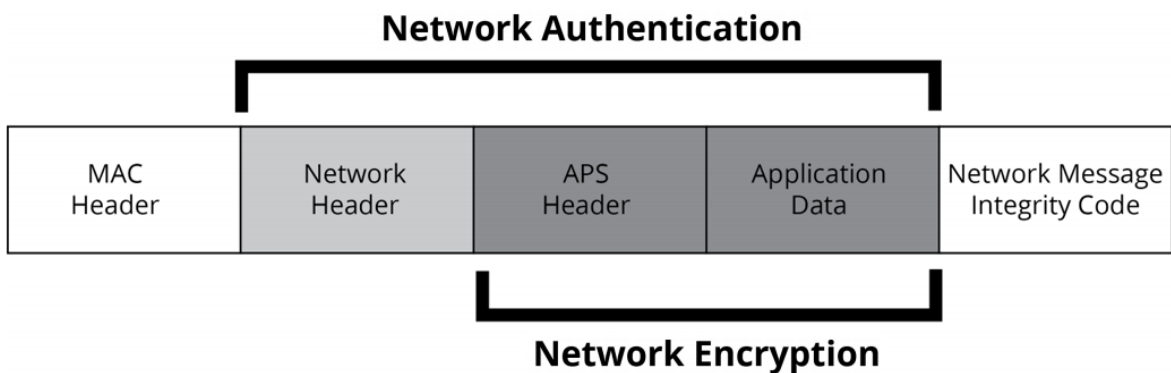

### Frame counter

The network header of encrypted packets includes a 32-bit frame counter. Each device in the network maintains a 32-bit frame counter that increments for every transmission. In addition, devices track the last known 32-bit frame counter for each of its neighbors. If a device receives a packet from a neighbor with a smaller frame counter than previously seen, it discards the packet. The device uses the frame counter to protect against replay attacks.

If the frame counter reaches a maximum value of 0xFFFFFFFF, it does not wrap to 0 and cannot send any more transmissions. Due to the size of the frame counters, reaching the maximum value is

uncommon for most applications. The following table shows the required time for the frame counter to reach its maximum value.

Average Transmission Rate	Time until 32-bit frame counter expires
1 / second	136 years
10 / second	13.6 years

To clear the frame counters without compromising security, you can change the network key in the network. When the network key is updated, the frame counters on all devices reset to 0. See [Network key updates](#) for details.

### ***Message integrity code***

The network header, APS header, and application data are all authenticated with 128-bit AES. The device performs a hash on these fields and is appended as a 4-byte message integrity code (MIC) to the end of the packet. The MIC allows receiving devices to ensure the message has not been changed. The MIC provides message integrity in the ZigBee security model. If a device receives a packet and the MIC does not match the device's own hash of the data, it drops the packet.

### ***Network layer encryption and decryption***

Packets with network layer encryption are encrypted and decrypted by each hop in a route. When a device receives a packet with network encryption, it decrypts the packet and authenticates the packet. If the device is not the destination, it then encrypts and authenticates the packet, using its own frame counter and source address in the network header section.

Since the device performs network encryption at each hop, packet latency is slightly longer in an encrypted network than in a non-encrypted network. Also, security requires 18 bytes of overhead to include a 32-bit frame counter, an 8-byte source address, 4-byte MIC, and 2 other bytes. This reduces the number of payload bytes that can be sent in a data packet.

### ***Network key updates***

ZigBee supports a mechanism for changing the network key in a network. When the network key is changed, the frame counters in all devices reset to 0.

### ***APS layer security***

APS layer security can be used to encrypt application data using a key that is shared between source and destination devices. Where network layer security is applied to all data transmissions and is decrypted and reencrypted on a hop-by-hop basis, APS security is optional and provides end-to-end security using an APS link key known by only the source and destination device. APS security cannot be applied to broadcast transmissions.

If you enable APS security, the APS header and data payload are authenticated with 128-bit AES as shown in the following image:

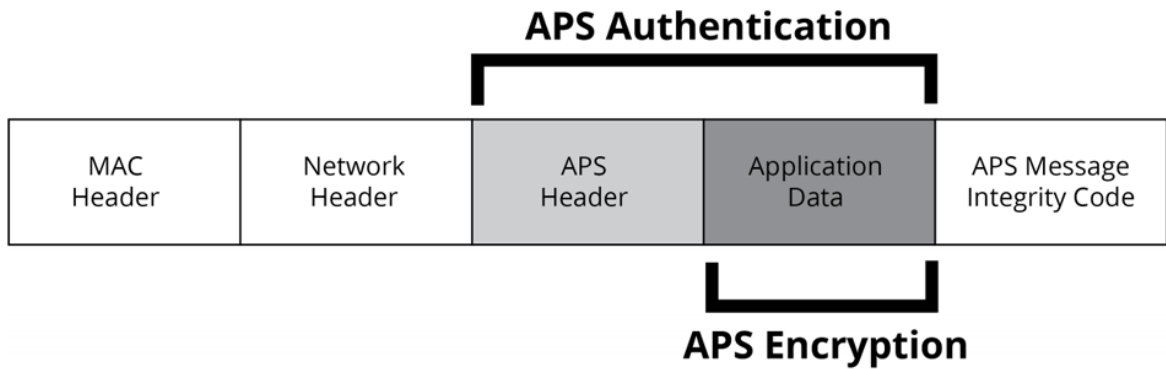

### ***Message integrity code***

If you enable APS security, the APS header and data payload are authenticated with 128-bit AES. The device performs a hash on these fields and appends as a 4-byte message integrity code (MIC) to the end of the packet. This MIC is different than the MIC appended by the network layer. The MIC allows the destination device to ensure the message has not been changed. If the destination device receives a packet and the MIC does not match the destination device's own hash of the data, it drops the packet.

### ***APS link keys***

There are two kinds of APS link keys: trust center link keys and application link keys. A trust center link key is established between a device and the trust center, where an application link key is established between a device and another device in the network where neither device is the trust center.

### ***APS layer encryption and decryption***

Packets with APS layer encryption are encrypted at the source and only decrypted by the destination. Since APS encryption requires a 5-byte header and a 4-byte MIC, the maximum data payload is reduced by 9 bytes when APS encryption is used.

### ***Network and APS layer encryption***

Network and APS layer encryption can both be applied to data. The following figure demonstrates the authentication and encryption performed on the final ZigBee packet when both are applied.

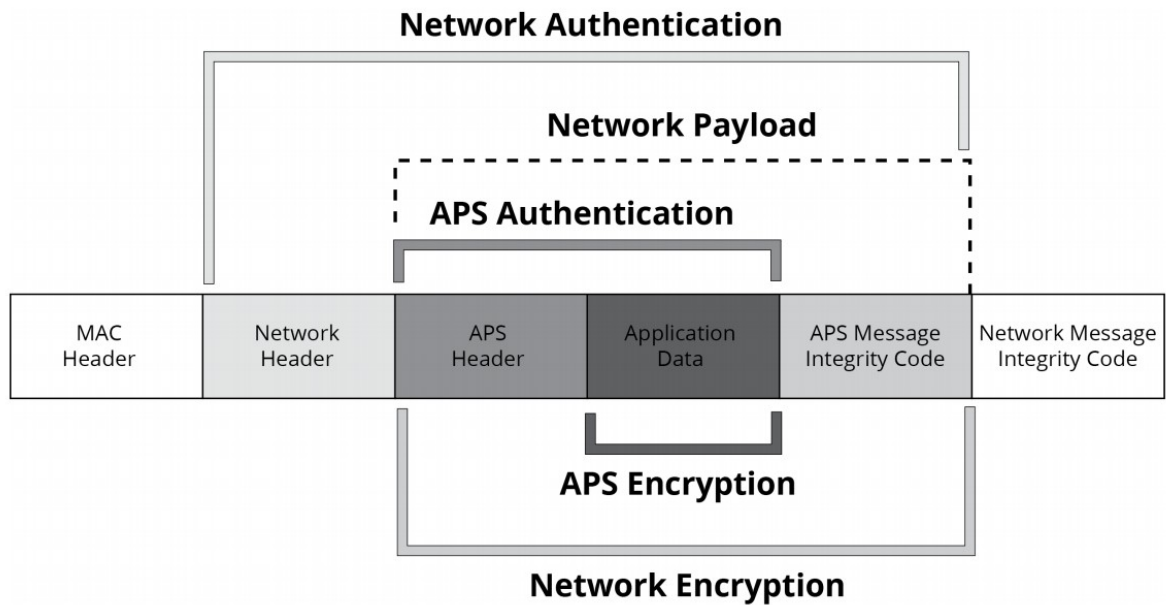

## Trust center

ZigBee defines a trust center device that is responsible for authenticating devices that join the network. The trust center also manages link key distribution in the network.

## Forming or joining a secure network

The coordinator is responsible for selecting a network encryption key. This key can either be preconfigured or randomly selected. In addition, the coordinator generally operates as a trust center and must select the trust center link key. The trust center link key can also be preconfigured or randomly selected.

Devices that join the network must obtain the network key when they join. When a device joins a secure network, the network and link keys can be sent to the joining device. If the joining device has a preconfigured trust center link key, the network key will be sent to the joining device encrypted by the link key. Otherwise, if the joining device is not preconfigured with the link key, the device could only join the network if the network key is sent unencrypted ("in the clear").

The trust center must decide whether or not to send the network key unencrypted to joining devices that are not preconfigured with the link key. We do not recommend sending the network key unencrypted as it can open a security hole in the network. To maximize security, preconfigure devices with the correct link key.

## Implementing security on the XBee

If you enable security in the XBee ZigBee firmware, devices acquire the network key when they join a network. Data transmissions are always encrypted with the network key, and can optionally be end-to-end encrypted with the APS link key.

## Enabling security

To enable security on a device, the Encryption Enable (**EE**) parameter must be set to 1. When the parameter value changes, the XBee module leaves the network (PAN ID and channel) it was operating on and attempt to form or join a new network.

If you set **EE** to 1, all data transmissions are encrypted with the network key. When you enable security, the maximum number of bytes in a single RF transmission will be reduced. For more information, see [NP \(Maximum Packet Payload Bytes\)](#).

---

**Note** The **EE** parameter must be set the same on all devices in a network. Changes to the **EE** command should be written to non-volatile memory (to be preserved through power cycle or reset events) using the **WR** command.

---

## Setting the network security key

The coordinator selects the network security key for the network using the Network Encryption Key (**NK**) parameter (write-only). If **NK**=0 (default), the coordinator will select a random network key. Otherwise, you set **NK** to a non-zero value, it uses this value as network security key.

**NK** is only supported on the coordinator. Routers and end devices with security enabled (**EE**=1) acquire the network key when they join a network. They receive the network key encrypted with the link key if they share a preconfigured link key with the coordinator.

---

**Note** In ZigBee, if **EE** and **EO** are set to 0x01, then the device sends the network key in the clear (unencrypted) with the link key at association time. This may be a useful setting in development environments, but we discourage it for product deployment for security reasons.

---

## Set the APS trust center link key

The coordinator must also select the trust center link key, using the **KY** command. If **KY** = 0 (default), the coordinator selects a random trust center link key (not recommended). Otherwise, if **KY** is set greater than 0, the device uses this value as the pre-configured trust center link key. **KY** is write-only and cannot be read.

---

**Note** Application link keys sent between two devices where neither device is the coordinator are not supported in ZB firmware.

---

### **Random trust center link keys**

If the coordinator selects a random trust center link key (**KY** = 0, default), then it allows devices to join the network without having a pre-configured link key. However, this sends the network key unencrypted over-the-air to joining devices and is not recommended.

### **Pre-configured trust center link keys**

If the coordinator uses a pre-configured link key (**KY** > 0), then it will not send the network key unencrypted to joining devices. Only devices with the correct pre-configured link key can to join and communicate on the network.

## Enable APS encryption

APS encryption is an optional layer of security that uses the link key to encrypt the data payload. Unlike network encryption that is decrypted and encrypted on a hop-by-hop basis, APS encryption is



only decrypted by the destination device. The XBee must be configured with security enabled (**EE** set to 1) to use APS encryption.

APS encryption can be enabled in API firmware on a per-packet basis. To enable APS encryption for a given transmission, set the "enable APS encryption" transmit options bit in the API transmit frame. Enabling APS encryption decreases the maximum payload size by nine bytes.

## Use a trust center

Use the Encryption Options (**EO**) parameter define the coordinator as a trust center. If the coordinator is a trust center, it received alerts to all new join attempts in the network. The trust center also has the ability to update or change the network key on the network.

In ZB firmware, you can establish a secure network with or without a trust center. Network and APS layer encryption are supported regardless of whether you use a trust center.

### **Updating the network key with a trust center.**

If the trust center has started a network and the **NK** value changes, the coordinator updates the network key on all devices in the network. Changes to **NK** will not force the device to leave the network. The network continues to operate on the same channel and PAN ID, but the devices in the network update their network key, increment their network key sequence number, and restore their frame counters to 0.

### **Updating the network key without a trust center.**

If the coordinator is not running as a trust center, the Network Reset (**NR1**) command can be used to force all devices in the network to leave the current network and rejoin the network on another channel. When devices leave and reform then network, the frame counters are reset to 0. This approach causes the coordinator to form a new network that the remaining devices should join. Resetting the network in this manner brings the coordinator and routers in the network down for about ten seconds, and causes the 16-bit PAN ID and 16-bit addresses of the devices to change.

In ZigBee firmware, a secure network can be established with or without a trust center. Network and APS layer encryption are supported regardless of whether a trust center is used.

## Security examples

This section covers some sample XBee device configurations to support different security modes and lists several **AT** commands with suggested parameter values.

In **AT** command mode, issue each command with a leading 'AT' and no '=' sign: For example, EE1. In the API, the two byte command is used in the command field, and parameters are populated as binary values in the parameter field.

### **Example 1: Forming a network with security (pre-configured link keys)**

1. Start a coordinator with the following settings:
  - a. **ID** = 2234 (arbitrarily selected)
  - b. **EE** = 1
  - c. **NK** = 0
  - d. **KY** = 4455
  - e. **WR** (save networking parameters to preserve them through power cycle)

2. Configure one or more routers or end devices with the following settings:
  - a. **ID** = 2234
  - b. **EE** = 1
  - c. **KY** = 4455
  - d. **WR** (save networking parameters to preserve them through power cycle)
3. Read the **AI** setting on the coordinator and joining devices until they return 0 (formed or joined a network).

This example sets the **EE**, **ID**, and **KY** commands the same on all devices. After successfully joining the secure network, the network key encrypts all application data transmissions. Since **NK** was set to 0 on the coordinator, the device selects a random network key. Because the link key (**KY**) was configured to a non-zero value on all devices, the pre-configured link key (**KY**) sends the network key encrypted when the devices joined.

### **Example 2: Forming a network with security (obtaining keys during joining)**

1. Start a coordinator with the following settings:
  - a. **ID** = 2235
  - b. **EE** = 1
  - c. **NK** = 0
  - d. **KY** = 0
  - e. **WR** (save networking parameters to persist through power cycle)
2. Configure one or more routers or end devices with the following settings:
  - a. **ID** = 2235
  - b. **EE** = 1
  - c. **KY** = 0
  - d. **WR** (save networking parameters to persist through power cycle)
3. Read the **AI** setting on the coordinator and joining devices until they return 0 (formed or joined a network).

This example sets the **EE**, **ID**, and **KY** commands the same on all devices. Since **NK** was set to 0 on the coordinator, the device selects a random network key. Because **KY** was set to 0 on all devices, the network key was sent unencrypted (“in the clear”) when the devices joined.



This approach introduces a security vulnerability into the network and is not recommended.

---

## Network commissioning and diagnostics

---

We call the process of discovering and configuring devices in a network for operation, "network commissioning." Devices include several device discovery and configuration features. In addition to configuring devices, you must develop a strategy to place devices to ensure reliable routes. To accommodate these requirements, modules include features to aid in placing devices, configuring devices, and network diagnostics.

### Place devices

For a network installation to be successful, installers must be able to determine where to place individual XBee devices to establish reliable links throughout the network.

### Device discovery

#### Network discovery

Use the network discovery command to discover all devices that have joined a network. Issuing the **ND** command sends a broadcast network discovery command throughout the network. All devices that receive the command send a response that includes:

- Device addressing information
- Node identifier string (see [NI \(Node Identifier\)](#))
- Other relevant information

You can use this command for generating a list of all module addresses in a network.

When a device receives the network discovery command, it waits a random time before sending a response. The device sets the maximum time delay on the **ND** sender with the **NT** command. The **ND** originator includes its **NT** setting in the transmission to provide a delay window for all devices in the network. Large networks may need to increase **NT** to improve network discovery reliability. The default **NT** value is 0x3C (6 seconds).

#### ZDO discovery

The ZigBee Device Profile includes provisions to discover devices in a network that are supported on all ZigBee devices (including non-Digi products). These include the LQI Request (cluster ID 0x0031) and the Network Update Request (cluster ID 0x0038). You can use the LQI Request to read the devices in the neighbor table of a remote device, and the Network Update Request for a remote device to complete an active scan to discover all nearby ZigBee devices. You can send both of these ZDO commands using the XBee Explicit API transmit frame (0x11). For more information, see [API Operation](#). Refer to the ZigBee specification for formatting details of these two ZDO frames.

## Joining Announce

All ZigBee devices send a ZDO Device Announce broadcast transmission when they join a ZigBee network (ZDO cluster ID 0x0013). These frames are sent out the XBee's serial port as an Explicit Rx Indicator API frame (0x91) if **AO** is set to 1. The device announce payload includes the following information:

[Sequence Number] + [16-bit address] + [64-bit address] + [Capability]

The 16-bit and 64-bit addresses are received in little-endian byte order (LSB first). See the ZigBee specification for details.

## Commissioning pushbutton and associate LED

XBee devices support a set of commissioning pushbutton and LED behaviors to aid in device deployment and commissioning. These include the commissioning push button definitions and associate LED behaviors. The following features can be supported in hardware:

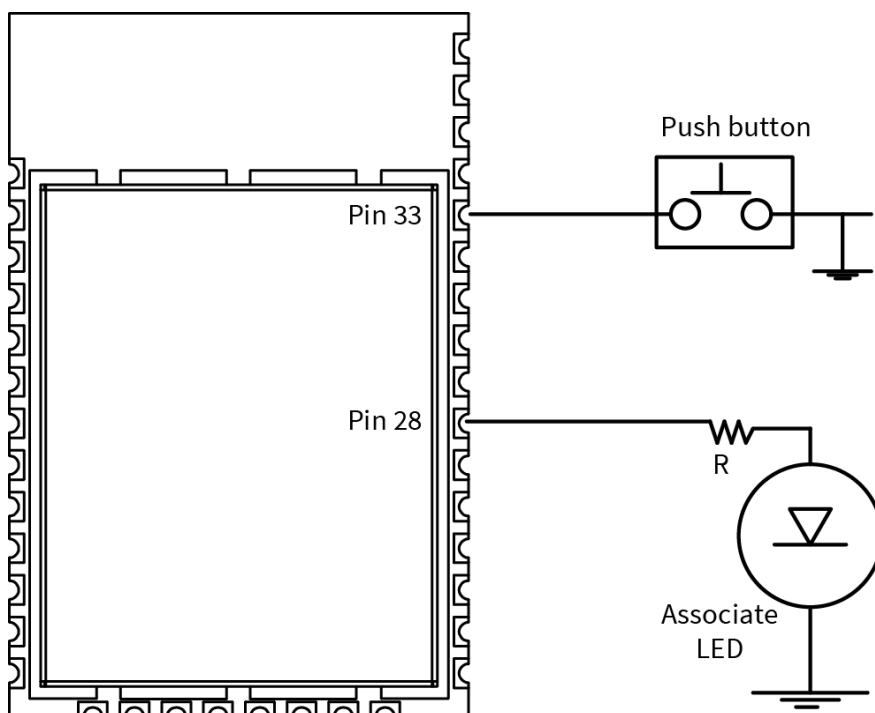

A pushbutton and an LED can be connected to XBee/XBee-PRO ZigBee RF Module pins 33 and 28 (SMT), or pins 20 and 15 (TH) respectively to support the commissioning pushbutton and associate LED functionalities.

### Commissioning pushbutton

The commissioning pushbutton definitions provide a variety of simple functions to help with deploying devices in a network. Enable the commissioning button functionality on pin 20 by setting the **DO** command to 1 (enabled by default).

Button presses	If device is joined to a network	If device is not joined to a network
1	Wakes an end device for 30 seconds Sends a node identification broadcast transmission	Wakes an end device for 30 seconds Blinks a numeric error code on the Associate pin indicating the cause of join failure.
2	Sends a broadcast transmission to enable joining on the coordinator and all devices in the network for 1 minute. (If joining is permanently enabled on a device ( <b>NJ</b> = 0xFF), this action has no effect on that device.)	N/A
4	Causes the device to leave the PAN. Issues <b>RE</b> to restore module parameters to default values, including <b>ID</b> and <b>SC</b> . The device attempts to join a network based on its ID and SC settings.	Issues ATRE to restore module parameters to default values, including <b>ID</b> and <b>SC</b> . The device attempts to join a network based on its <b>ID</b> and <b>SC</b> settings.

You can simulate button presses in software using the **CB** command. Issue a **CB** command with a parameter set to the number of button presses you want executed. For example, sending **CB1** executes the actions associated with a single button press.

The node identification frame is similar to the node discovery response frame; it contains the device’s address, node identifier string (**NI** command), and other relevant data. All API devices that receive the node identification frame send it out their serial interface as an API Node Identification Indicator frame (0x95).

### Associate LED

The Associate pin (pin 28/SMT, pin 33/TH) provides an indication of the device’s network status and diagnostics information. Connect an LED to the Associate pin as shown in the figure in [Commissioning pushbutton and associate LED](#). Enable the Associate LED functionality the **D5** command to 1 (enabled by default). If the Associate pin is enabled, it configured as an output.

### Joined indication

The Associate pin indicates the network status of a device. If the device is not joined to a network, the Associate pin is set high. Once the device successfully joins a network, the Associate pin blinks at a regular time interval. The following figure shows the joined status of a device.

Associate

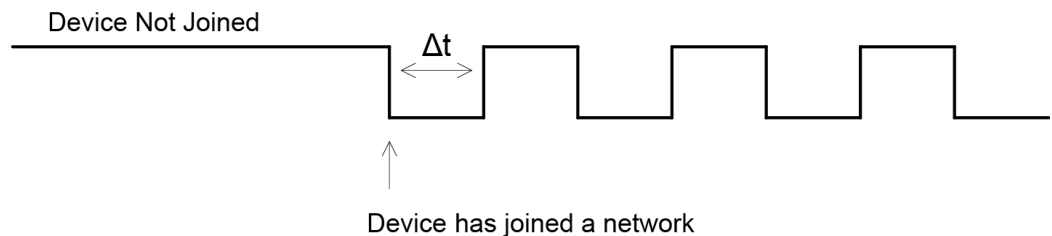

The associate pin can indicate the joined status of a device. Once the device has joined a network, the associate pin toggles state at a regular interval ( $\Delta t$ ). Use the **LT** command to set the time.

The **LT** command defines the blink time of the Associate pin. If it is set to 0, the device uses the default blink time (500 ms for coordinator, 250 ms for routers and end devices).

### Diagnostics support

The Associate pin works with the commissioning pushbutton to provide additional diagnostics behaviors to aid in deploying and testing a network. If the commissioning push button is pressed once, and the device has not joined a network, the Associate pin blinks a numeric error code to indicate the cause of join failure. The number of blinks is equal to (**AI** value - 0x20). For example, if **AI** = 0x22, 2 blinks occur.

If the commissioning push button is pressed once and the device has joined a network, the device transmits a broadcast node identification packet. If the Associate LED functionality is enabled (**D5** command), a device that receives this transmission will blink its Associate pin rapidly for 1 second.

The following image illustrates the behavior pressing the commissioning button press once when the device has not joined a network, causing the associate pin to blink to indicate the **AI** Code where: **AI** = # blinks + 0x20. In this example, **AI** = 0x22.

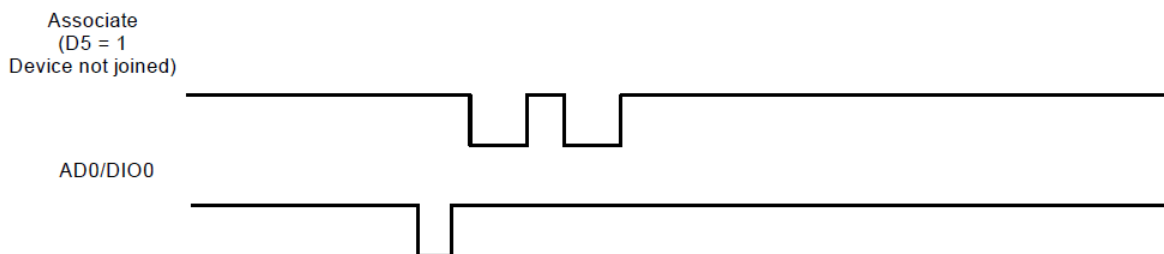

The following image illustrates the behavior pressing the button once on a remote device, causing a broadcast node identification transmission to be sent. All devices that receive this transmission blink their associate pin rapidly for one second if the associate LED functionality is enabled (**D5** = 1).

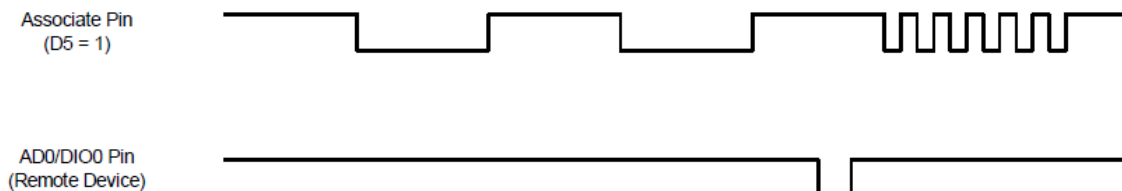

## Binding

The Digi XBee firmware supports three binding request messages:

- End Device Bind
- Bind
- Unbind

### End\_Device\_Bind\_req

The End Device Bind request (ZDO cluster 0x0020) is described in the ZigBee Specification.

During a deployment, an installer may need to bind a switch to a light. After pressing a commissioning button sequence on each device, this causes them to send End\_Device\_Bind\_req messages to the Coordinator within a time window (60 s). The payload of each message is a simple descriptor which

lists input and output clusterIDs. The Coordinator matches the requests by pairing complementary clusterIDs. After a match has been made, it sends messages to bind the devices together. When the process is over, both devices will have entries in their binding tables which support indirect addressing of messages between their bound endpoints.

R1->C End\_Device\_Bind\_req

R2->C End\_Device\_Bind\_req

R1, R2 send End\_Device\_Bind\_req within 60 s of each other to C

C matches the requests.

C tests one to see if binding is already in place:

R2<-C Unbind\_req

R2->C Unbind-rsp (status code - NO\_ENTRY)

C proceeds to create binding table entries on the two devices.

R1<-C Bind\_req

R1->C Bind\_rsp

R2<-C Bind\_req

R2->C Bind\_rsp

C sends responses to the original End\_Device\_Bind\_req messages.

R1-<C End\_Device\_Bind\_rsp

R2-<C End\_Device\_Bind\_rsp

#### **End Device binding sequence (binding)**

This message has a toggle action. If the same two devices were to subsequently send End\_Device\_Bind\_req messages to the Coordinator, the Coordinator would detect they were already bound, and then send Unbind\_req messages to remove the binding.

An installer can use this to remove a binding which was made incorrectly, say from a switch to the wrong lamp, by repeating the commissioning button sequence used beforehand.

R1->C End\_Device\_Bind\_req

R2->C End\_Device\_Bind\_req

R1, R2 send End\_Device\_Bind\_req within 60 s of each other to C

C matches the requests.

C tests one to see if binding is already in place:

R2<-C Unbind\_req

R2->C Unbind-rsp (status code - SUCCESS)

C proceeds to remove binding table entries from the two devices.

R1<-C Unbind\_req

R1->C Unbind\_rsp

R2<-C Unbind\_req

R2->C Unbind\_rsp

C sends responses to the original End\_Device\_Bind\_req messages.

R1-<C End\_Device\_Bind\_rsp

R2-<C End\_Device\_Bind\_rsp

#### **End Device binding sequence (removal)**

This example shows a correctly formatted End\_Device\_Bind\_req (ZDO cluster 0x0020) using a Digi 0x11 Explicit API Frame:





### **Example of a End\_Device\_Bind\_req**

#### **Bind\_req**

The Bind request (ZDO cluster 0x0021) is described in the ZigBee Specification. A binding may be coded for either a unicast or a multicast/groupID message.

#### **Unbind\_req**

The Unbind request (ZDO cluster 0x0022) is described in the ZigBee Specification.

## **Group Table API**

Unlike the Binding Table that is managed with ZDO commands, a ZigBee Group Table is managed by the ZigBee Cluster Library Groups Cluster (0x0006) with ZCL commands.

The Digi ZigBee XBee firmware is intended to work with an external processor where a Public Application Profile with endpoints and clusters is implemented, including a Groups Cluster. Configure the ZigBee XBee firmware to forward all ZCL commands addressed to this Group Cluster out the UART (see ATA03). The ZigBee XBee will not use remote Groups Cluster commands to manage its own Group Table.

But to implement multicast (group) addressing within the XBee, the external processor must keep the XBee's group table state in sync with its own. For this reason, a Group Table API has been defined where the external processor can manage the state of the ZigBee XBee's group table.

The design of the Group Table API of the XBee firmware derives from the ZCL Group Cluster 0x0006. Use the Explicit API frame 0x11 addressed to the Digi Device Object endpoint (0xE6) with the Digi XBee ProfileID (0xC105) to send commands and requests to the local device.

The ZigBee Home Automation Public Application Profile says groups should only be used for sets of more than five devices. This implies sets of five or fewer devices should be managed with multiple binding table entries.

There are five commands implemented in the API:

- [Add group](#)
- [View group](#)
- [Get Group Membership](#)
- [Remove Group](#)
- [Remove All Groups](#)

There is a sixth command of the Group Cluster described in the ZCL: Add Group If Identifying. This command is not supported in this API, because its implementation requires access to the Identify Cluster, which is not maintained on the XBee. The external processor needs to implement that server command while using the Group Table API to keep the XBee device's group table in sync using the five command primitives.

### **Add group**

The purpose of the Add Group command is to add a group table entry to associate an active endpoint with a groupID and optionally a groupName. The groupID is a two byte value. The groupName consists of zero to 16 ASCII characters.

The following example adds a group table entry which associates endpoint E7 with groupID 1234 and groupName "ABCD".

**The example packet is given in three parts, the preamble, ZCL Header, and ZCL payload:**

Preamble = "11 01 "+LocalDevice64Addr+"FFFE E6 E7 0006 C105 00 00"

The packet is addressed to the local node, using a source endpoint of 0xE6, clusterID of 0x0006, and profileID of 0xC105. The destination endpoint E7 holds the endpoint parameter for the “Add Group” command.

ZCL\_header = “01 ee 00”

The first field (byte) is a frame control field which specifies a Cluster Specific command (0x01) using a Client->Server direction(0x00). The second field is a transaction sequence number used to associate the response with the command request. The third field is the command identifier for “Add Group” (0x00)[2].

ZCL\_payload = “3412 04 41 42 43 44”

The first two bytes is the group Id to add in little endian representation. The next byte is the string name length (00 if there is no string). The other bytes are the descriptive ASCII string name (“ABCD”) for the group table entry. The string is represented with its length in the first byte, and the other bytes containing the ASCII characters.

**The example packet in raw hex byte form:**

7e001e11010013a2004047b55cfff6e70006c105000001ee0034120441424344c7

**The response in raw hex byte form, consisting of two packets:**

7e0018910013a2004047b55cfff6e7e68006c1050009ee0000341238

7e00078b01fffe00000076

**The response in decoded form:**

ZigBee Explicit Rx Indicator

API 0x91 64DestAddr 0x0013A2004047B55C 16DestAddr 0xFFFF SrcEP 0xE7 DestEP 0xE6

ClusterID 0x8006 ProfileID 0xC105 Options 0x00

RF\_Data 0x09EE00003412

**The response in terms of Preamble, ZCL Header, and ZCL payload:**

Preamble = “910013a2004047b55cfff6e7e68006c10500”

The packet has its endpoint values reversed from the request, and the clusterID is 0x8006 indicating a Group cluster response.

ZCL\_header = “09 ee 00”

The first field is a frame control field which specifies a Cluster Specific command (0x01) using a Server-> Client direction. The second field is a transaction sequence number used to associate the response with the command request. The third field is the command identifier “Add Group” (0x00)[2].

ZCL\_payload = “00 3412”

The first byte is a status byte (SUCCESS=0x00)[3][4]. The next two bytes hold the group ID (0x1234) in little endian form.

This is the decoded second message, which is a Tx Status for the original command request. If the Frameld value in the original command request had been zero, or if no space was available in the transmit UART buffer, then no Tx Status message occurs.

ZigBee Tx Status

API 0x8B FrameID 0x01 16DestAddr 0xFFFF

Transmit Retries 0x00 Delivery Status 0x00 Discovery Status 0x00 Success

**View group**

The purpose of the View Group command is to get the name string which is associated with a particular endpoint and groupID.

The following example gets the name string associated with the endpoint E7 and groupID 1234.

**The packet:**

```
Preamble = "11 01 "+LocalDevice64Addr+"FFFE E6 E7 0006 C105 00 00"
```

The packet is addressed to the local node, using a source endpoint of 0xE6, clusterID of 0x0006, and profileID of 0xC105. The destination endpoint E7 is the endpoint parameter for the "View Group" command.

```
ZCL_header = "01 ee 01"
```

The first field is a frame control field which specifies a Cluster Specific command (0x01) using a Client->Server direction(0x00). The second field is a transaction sequence number which is used to associate the response with the command request. The third field is the command identifier "View Group" (0x01) [5].

```
ZCL_payload = "3412"
```

The two byte value is the groupID in little-endian representation.

#### The packet in raw hex byte form:

```
7e001911010013a2004047b55cffffee6e70006c105000001ee013412d4
```

#### The response in raw hex byte form, consisting of two packets:

```
7e001d910013a2004047b55cffffee7e68006c1050009ee01003412044142434424
```

```
7e00078b01ffffe00000076
```

#### The command response in decoded form:

```
ZigBee Explicit Rx Indicator
```

```
API 0x91 64DestAddr 0x0013A2004047B55C 16DestAddr 0xFFFF SrcEP 0xE7 DestEP 0xE6
```

```
ClusterID 0x8006 ProfileID 0xC105 Options 0x00
```

```
RF_Data 0x09EE010034120441424344
```

#### The response in terms of Preamble, ZCL Header, and ZCL payload:

```
Preamble = "910013a2004047b55cffffee7e68006c10500"
```

The packet has its endpoint values reversed from the request, and the clusterID is 0x8006 indicating a Group cluster response.

```
ZCL_header = "09 ee 01"
```

The first field is a frame control field which specifies a Cluster Specific command (0x01) using a Server->Client direction (0x08). The second field is a transaction sequence number which associates the response with the command request. The third field is the command identifier "View Group" (0x01) [6].

```
ZCL_payload = "00 3412 0441424344"
```

The first byte is a status byte (SUCCESS=0x00)[6][4]. The next two bytes hold the groupID (0x1234) in little-endian form. The next byte is the name string length (0x04). The remaining bytes are the ASCII name string characters ("ABCD").

The following is the decoded second message, which is a Tx Status for the original command request. If the Frameld value in the original command request had been zero, or if no space was available in the transmit UART buffer, then no Tx Status message would occur.

```
ZigBee Tx Status
```

```
API 0x8B FrameID 0x01 16DestAddr 0xFFFF
```

```
Transmit Retries 0x00 Delivery Status 0x00 Discovery Status 0x00 Success
```

## Get Group Membership

### Get Group Membership (1 of 2)

The purpose of this first form of the Get Group Membership command is to get all the groupIDs associated with a particular endpoint.

The intent of the example is to get all the groupIDs associated with endpoint E7.

**The example packet is given in three parts, the preamble, ZCL Header, and ZCL payload:**

```
Preamble = "11 01 "+LocalDevice64Addr+"FFFE E6 E7 0006 C105 00 00"
```

The packet is addressed to the local node, using a source endpoint of 0xE6, clusterID of 0x0006, and profileID of 0xC105. The destination endpoint E7 holds the endpoint parameter for the "Get Group Membership" command.

```
ZCL_header = "01 ee 02"
```

The first field (byte) is a frame control field which specifies a Cluster Specific command (0x02) using a Client->Server direction(0x00). The second field is a transaction sequence number which is used to associate the response with the command request. The third field is the command identifier for "Get Group Membership" (0x02) [7].

```
ZCL_payload = "00"
```

The first byte is the group count. If it is zero, then all groupIDs with an endpoint value which matches the given endpoint parameter will be returned in the response.

**The example packet in raw hex byte form:**

```
7e001811010013a2004047b55cffffe6e70006c105000001ee020019
```

**The response in raw hex byte form, consisting of two packets:**

```
7e0019910013a2004047b55cffffe7e68006c1050009ee02ff01341235
```

```
7e00078b01ffffe00000076
```

**The response in decoded form:**

```
ZigBee Explicit Rx Indicator
```

```
API 0x91 64DestAddr 0x0013A2004047B55C 16DestAddr 0xFFFF SrcEP 0xE7 DestEP 0xE6
ClusterID 0x8006 ProfileID 0xC105 Options 0x00
```

```
RF_Data 0x09EE02FF013412
```

**The response in terms of Preamble, ZCL Header, and ZCL Payload:**

```
Preamble = "910013a2004047b55cffffe7e68006c10500"
```

The packet has the endpoints reversed from the request, and the clusterID is 0x8006 indicating a Group cluster response.

```
ZCL_header = "09 ee 02"
```

The first field is a frame control field which specifies a Cluster Specific command (0x01) using a Server->Client direction (0x08). The second field is a transaction sequence number which is used to associate the response with the command request. The third field is the command identifier "Get Group Membership" (0x02) [8].

```
ZCL_payload = "FF 01 3412"
```

The first byte is the remaining capacity of the group table. 0xFF means unknown. The XBee returns this value because the capacity of the group table is dependent on the remaining capacity of the binding table, thus the capacity of the group table is unknown. The second byte is the group count (0x01). The remaining bytes are the groupIDs in little-endian representation.

The following is the decoded second message, which is a Tx Status for the original command request. If the Frameld value in the original command request had been zero, or if no space was available in the transmit UART buffer, then no Tx Status message would occur.

```
ZigBee Tx Status
API 0x8B FrameID 0x01 16DestAddr 0xFFFE
Transmit Retries 0x00 Delivery Status 0x00 Discovery Status 0x00 Success
```

**Get Group Membership (2 of 2)**

The purpose of this second form of the Get Group Membership command is to get the set of groupIDs associated with a particular endpoint which are a subset of a list of given groupIDs.

The following example gets the groupIDs associated with endpoint E7 which are a subset of a given list of groupIDs (0x1234, 0x5678).

**The example packet is given in three parts, the preamble, ZCL Header, and ZCL payload:**

```
Preamble = "11 01 "+LocalDevice64Addr+"FFFE E6 E7 0006 C105 00 00"
```

The packet is addressed to the local node, using a source endpoint of 0xE6, clusterID of 0x0006, and profileID of 0xC105. The destination endpoint E7 is the endpoint parameter for the "Get Group Membership" command.

```
ZCL_header = "01 ee 02"
```

The first field (byte) is a frame control field which specifies a Cluster Specific command (0x02) using a Client->Server direction(0x00). The second field is a transaction sequence number which is used to associate the response with the command request. The third field is the command identifier for "Get Group Membership" (0x02) [7].

```
ZCL_payload = "02 34127856"
```

The first byte is the group count. The remaining bytes are a groupIDs which use little-endian representation.

**The example packet in raw hex byte form:**

```
7e001c11010013a2004047b55cffffe6e70006c105000001ee02023412785603
```

The response in raw hex byte form, consisting of two packets:

```
7e0019910013a2004047b55cffffe7e68006c1050009ee02ff01341235
```

```
7e00078b01ffffe00000076
```

**The response in decoded form:**

```
ZigBee Explicit Rx Indicator
API 0x91 64DestAddr 0x0013A2004047B55C 16DestAddr 0xFFFE SrcEP 0xE7 DestEP 0xE6
ClusterID 0x8006 ProfileID 0xC105 Options 0x00
RF_Data 0x09EE02FF013412
```

**The response in terms of Preamble, ZCL Header, and ZCL Payload:**

```
Preamble = "910013a2004047b55cfffee7e68006c10500"
```

The packet has the endpoints reversed from the request, the clusterID is 0x8006 indicating a Group cluster response.

```
ZCL_header = "09 ee 02"
```

The first field is a frame control field which specifies a Cluster Specific command (0x01) using a Server->Client direction (0x08). The second field is a transaction sequence number which is used to associate the response with the command request. The third field is the command identifier "Get Group Membership" (0x02) [8].

```
ZCL_payload = "FF 01 3412"
```

The first byte is the remaining capacity of the group table. 0xFF means unknown. The XBee returns this value because the capacity of the group table is dependent on the remaining capacity of the binding table, thus the capacity of the group table is unknown. The second byte is the group count (0x01). The remaining bytes are the groupIDs in little-endian representation.

The following is the decoded second message, which is a Tx Status for the original command request. If the Frameld value in the original command request had been zero, or if no space was available in the transmit UART buffer, then no Tx Status message occurs.

```
ZigBee Tx Status
```

```
API 0x8B      FrameID 0x01    16DestAddr 0xFFFE
```

```
Transmit Retries 0x00 Delivery Status 0x00 Discovery Status 0x00 Success
```

**Remove Group**

The purpose of the Remote Group command is to remove a Group Table entry which associates a given endpoint with a given groupID.

The intent of the example is to remove the association of groupID [TBD] with endpoint E7.

The example packet is given in three parts: the preamble, ZCL Header, and ZCL payload.

```
Preamble = "11 01 "+LocalDevice64Addr+"FFFE E6 E7 0006 C105 00 00"
```

The packet is addressed to the local node, using a source endpoint of 0xE6, clusterID of 0x0006, and profileID of 0xC105. The destination endpoint E7 is the endpoint parameter for the "Remove Group" command.

```
ZCL_header = "01 ee 03"
```

The first field is a frame control field which specifies a Cluster Specific command (0x01) using a Client->Server direction(0x00). The second field is a transaction sequence number which is used to associate the response with the command request. The third field is the command identifier "Remove Group" (0x03) [9].

```
ZCL_payload = "3412"
```

The two bytes value is the groupID to be removed in little-endian representation.

**The packet in raw hex byte form:**

```
7e001911010013a2004047b55cfffee6e70006c105000001ee033412d2
```

**The response in raw hex byte form, consisting of two packets:**

```
7e0018910013a2004047b55cfffee7e68006c1050009ee0300341235
```

```
7e00078b01fffe00000076
```

**The command response in decoded form:**

```
ZigBee Explicit Rx Indicator
```

```
API 0x91 64DestAddr 0x0013A2004047B55C 16DestAddr 0xFFFE SrcE 0xE DestEP 0xE6
```

```
ClusterID 0x8006 ProfileID 0xC105 Options 0x00
```

```
RF_Data 0x09EE03003412
```

**The response in terms of Preamble, ZCL Header, and ZCL payload:**

```
Preamble = "910013a2004047b55cfffee7e68006c10500"
```

The packet has its endpoint values reversed from the request, and the clusterID is 0x8006 indicating a Group cluster response.

```
ZCL_header = "09 ee 03"
```

The first field is a frame control field which specifies a Cluster Specific command (0x01) using a Server->Client direction (0x08). The second field is a transaction sequence number which is used to associate the response with the command request. The third field is the command identifier "Remove Group" (0x03) [10].

```
ZCL_payload = "00 3412"
```

The first byte is a status byte (SUCCESS=0x00)[10][4]. The next two bytes is the groupID (0x1234) value in little- endian form.

The following is the decoded second message, which is a Tx Status for the original command request. If the Frameld value in the original command request had been zero, or if no space was available in the transmit UART buffer, then no Tx Status message would occur.

```
ZigBee Tx Status
```

```
API 0x8B FrameID 0x01 16DestAddr 0xFFFE
```

```
Transmit Retries 0x00 Delivery Status 0x00 Discovery Status 0x00 Success
```

**Remove All Groups**

The purpose of the Remove All Groups command is to clear all entries from the group table which are associated with a target endpoint.

The following example removes all groups associated with endpoint E7.

**The packet:**

```
Preamble = "11 01 "+LocalDevice64Addr+"FFFE E6 E7 0006 C105 00 00"
```

The packet is addressed to the local node, using a source endpoint of 0xE6, clusterId of 0x0006, and profileID of 0xC105. The destination endpoint E7 is the endpoint parameter for the "Remove All Groups" command.

```
ZCL_header = "01 ee 04"
```

The first field is a frame control field which specifies a Cluster Specific command (0x01) using a Client->Server direction(0x00). The second field is a transaction sequence number which is used to associate the response with the command request. The third field is the command identifier "Remove All Groups" (0x04) [11].

```
ZCL_payload = ""
```

```
No payload is needed for this command.
```

**The packet in raw hex byte form:**

```
7e001711010013a2004047b55cffffee6e70006c105000001ee0417
```

**The response in raw hex byte form, consisting of two packets:**

```
7e0016910013a2004047b55cffffee7e68006c1050009ee04007c
```

```
7e00078b01ffffe00000076
```

**The command response in decoded form:**

```
ZigBee Explicit Rx Indicator
```

```
API 0x91 64DestAddr 0x0013A2004047B55C 16DestAddr 0xFFFFE SrcEP 0xE7 DestEP
0xE6
```

```
ClusterID 0x8006 ProfileID 0xC105 Options 0x00
```

```
RF_Data 0x09ee0400
```

**The response in terms of Preamble, ZCL Header, and ZCL payload.**

```
Preamble = "910013a2004047b55cffffee7e68006c10500"
```

The packet has its endpoints values reversed from the request, and the clusterID is 0x8006 indicating a Group cluster response.

```
ZCL_header = "09 ee 04"
```

The first field is a frame control field which specifies a Cluster Specific command (0x01) using a Server->Client direction (0x08). The second field is a transaction sequence number which is used to associate the response with the command request. The third field is the command identifier "Remove All Groups" (0x04) [10].

```
ZCL_payload = "00"
```

The first byte is a status byte (SUCCESS=0x00)[4].

And here is the decoded second message, which is a Tx Status for the original command request. If the FrameID value in the original command request had been zero, or if no space was available in the transmit UART buffer, then no Tx Status message would occur.

```
ZigBee Tx Status
```

```
API 0x8B FrameID 0x01 16DestAddr 0xFFFFE
```

```
Transmit Retries 0x00 Delivery Status 0x00 Discovery Status 0x00 Success
```

**Additional information**

This section provides additional information related to the Group Table API.

**Default responses**

Many errors are returned as a default response. For example, a RFData payload of a response containing 08010b788b would be decoded as:

```
ZCL_header = "08 01 03" - general command/server-to-client, transseqnum=1,
default_response_command(0x03)
```

```
ZCL_payload = "78 8b" - original cmdID, status code (0x8b)
```

```
EMBER_ZCL_STATUS_NOT_FOUND
```

**Common status codes**

This section lists some of the more frequently occurring status codes.



```
0x00 EMBER_ZCL_STATUS_SUCCESS: Command request was successful
0x01 EMBER_ZCL_STATUS_FAILURE: Command request failed - for example,
a call to remove an entry from the group table returned an error
0x80 EMBER_ZCL_STATUS_MALFORMED_COMMAND: no RFDData in the API frame;
ZCL Payload appears truncated from what is expected
0x81 EMBER_ZCL_STATUS_UNSUP_CLUSTER_COMMAND: unexpected direction
in the Frame Control Field of the ZCL Header; unexpected command identifier code
value
in the ZCL header
0x82 EMBER_ZCL_STATUS_UNSUP_GENERAL_COMMAND: unexpected frametype
in the Frame Control Field of the ZCL Header
0x84 EMBER_ZCL_STATUS_UNSUP_MANUF_GENERAL_COMMAND: unexpected
manufacturer specific indication in the Frame Control Field of the ZCL Header
0x8b EMBER_ZCL_STATUS_NOT_FOUND: An attempt at Get Group Membership or
Remove Group could not find a matching entry in the group table
```

A full set of status codes appears in the ZigBee Cluster Library [4].

### **Bibliography**

[1] ZigBee Cluster Library, document 075123r02, section 3.6.

The following cross references all appear in the ZigBee Cluster Library document (See the Add Group Response section of the ZigBee Cluster Library Specification, available online.):

[2] Add Group Command, section 3.6.2.2.3.

[3] Add Group Response, section 3.6.2.3.1.

[4] Status Enumerations, section 2.5.3.

[5] View Group Command, section 3.6.2.2.4.

[6] View Group Response, section 3.6.2.3.2.

[7] Get Group Membership Command, section 3.6.2.2.5.

[8] Get Group Membership Response, section 3.6.2.3.3.

[9] Remove Group Command, section 3.6.2.2.6.

[10] Remove Group Response, section 3.6.2.3.4.

[11] Remove All Groups Command, section 3.6.2.2.7.

## Managing End Devices

---

ZigBee end devices are intended to be battery-powered devices capable of sleeping for extended periods of time. Since end devices may not be awake to receive RF data at a given time, routers and coordinators are equipped with additional capabilities (including packet buffering and extended transmission timeouts) to ensure reliable data delivery to end devices.

End Device operation .....	123
Parent operation .....	123
Non-Parent device operation .....	124
XBee End Device configuration .....	125
Recommended sleep current measurements .....	132
Transmitting RF data .....	133
Receiving RF data .....	133
I/O sampling .....	134
Waking end devices with the Commissioning Pushbutton .....	134
Parent verification .....	134
Rejoining .....	134
Router/Coordinator configuration .....	135
Putting it all together .....	137

## End Device operation

When an end device joins a ZigBee network, it must find a router or coordinator device that is allowing end devices to join. Once the end device joins a network, it forms a parent-child relationship with the end device and the router or coordinator that allowed it to join. For more information, see [ZigBee networks](#).

When the end device is awake, it sends poll request messages to its parent. When the parent receives a poll request, it checks a packet queue to see if it has any buffered messages for the end device. It then sends a MAC layer acknowledgment back to the end device that indicates if it has data to send to the end device or not.

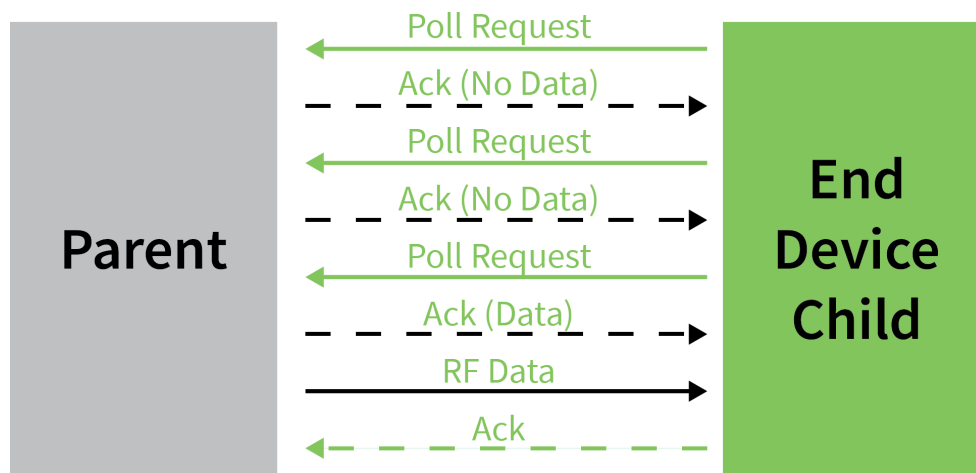

If the end device receives the acknowledgment and finds that the parent has no data for it, the end device can return to idle mode or sleep. Otherwise, it remains awake to receive the data. This polling mechanism allows the end device to enter idle mode and turn its receiver off when RF data is not expected in order to reduce current consumption and conserve battery life.

The end device can only send data directly to its parent. If an end device must send a broadcast or a unicast transmission to other devices in the network, it sends the message directly to its parent and the parent performs any necessary route or address discoveries to route the packet to the final destination.

## Parent operation

Each router or coordinator maintains a child table that contains the addresses of its end device children. A router or coordinator that has unused entries in its child table has end device capacity, or the ability to allow new end devices to join. If the child table is completely filled (such that the number of its end device children matches the number of child table entries), the device cannot allow any more end devices to join.

Since the end device children are not guaranteed to be awake at a given time, the parent is responsible for managing incoming data packets of its end device children. If a parent receives an RF data transmission destined for one of its end device children, and if the parent has enough unused buffer space, it buffers the packet. The data packet remains buffered until a timeout expires, or until the end device sends a poll request to retrieve the data.

The parent can buffer one broadcast transmission for all of its end device children. When the parent receives and buffers a broadcast transmission, it sets a flag in its child table when each child polls and retrieves the packet. Once all children have received the broadcast packet, the parent discards the buffered broadcast packet. If all children have not received a buffered broadcast packet and the

parent receives a new broadcast, it discards the old broadcast packet, clears the child table flags, and buffers the new broadcast packet for the end device children as shown in the following figure.

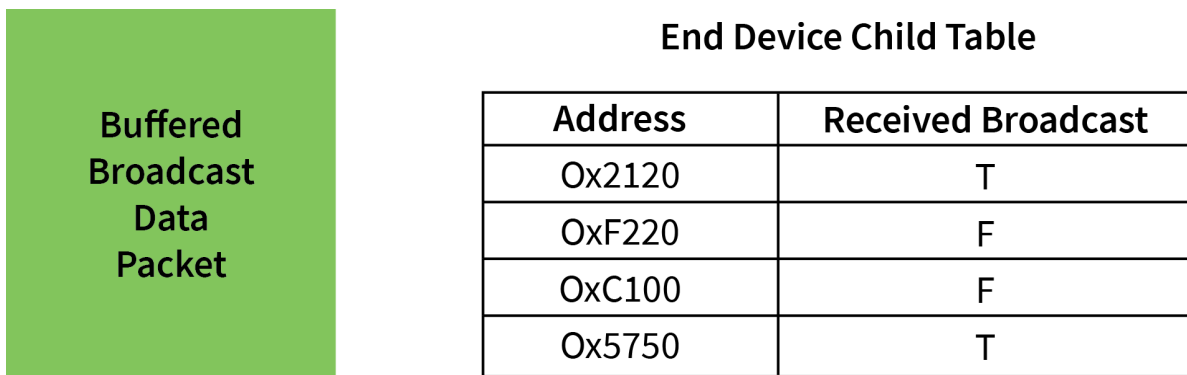

When an end device sends data to its parent that is destined for a remote device in the network, the parent buffers the data packet until it can establish a route to the destination. The parent may perform a route or 16-bit address discovery of its end device children. Once a route is established, the parent sends the data transmission to the remote device.

### End Device poll timeouts

To better support mobile end devices (end devices that can move within a network), parent router and coordinator devices have a poll timeout for each end device child. If an end device does not send a poll request to its parent within the poll timeout, the parent removes the end device from its child table. This allows the child table on a router or coordinator to better accommodate mobile end devices in the network.

### Packet buffer usage

Packet buffer usage on a router or coordinator varies depending on the application. The following activities can require use of packet buffers for up to several seconds:

- Route and address discoveries
- Application broadcast transmissions
- Stack broadcasts (e.g. ZDO “Device Announce” messages when devices join a network)
- Unicast transmissions buffered until acknowledgment is received from destination or retries exhausted
- Unicast messages waiting for end device to wake

Applications that use regular broadcasting or that require regular address or route discoveries use up a significant number of buffers, reducing the buffer availability for managing packets for end device children. Applications can reduce the number of required application broadcasts, and consider implementing an external address table or many-to-one and source routing if necessary to improve routing efficiency.

## Non-Parent device operation

Devices in the ZigBee network treat data transmissions to end devices differently than transmissions to other routers and coordinators. When a device sends a unicast transmission, if it does not receive a network acknowledgment within a timeout, the device resends the transmission. When transmitting

data to remote coordinator or router devices, the transmission timeout is relatively short since these devices are powered and responsive.

However, since end devices may sleep for some time, unicast transmissions to end devices use an extended timeout mechanism in order to allow enough time for the end device to wake and receive the data transmission from its parent.

If a non-parent device does not know the destination is an end device, it uses the standard unicast timeout for the transmission. However, provisions exist in the Ember ZigBee stack for the parent to inform the message sender that the destination is an end device. Once the sender discovers the destination device is an end device, future transmissions will use the extended timeout. For more information see [Router/Coordinator configuration](#).

## XBee End Device configuration

XBee end devices support three different sleep modes:

- Pin Sleep
- Cyclic Sleep
- Cyclic Sleep with pin wake-up

Pin sleep allows an external microcontroller to determine when the XBee sleeps and when it wakes by controlling the Sleep\_RQ pin. In contrast, cyclic sleep allows the sleep period and wake times to be configured through the use of AT commands. Cyclic sleep with pin wake-up is the same as cyclic sleep except the device can be awakened before the sleep period expires by lowering the Sleep\_Rq line. The sleep mode is configurable with the SM command.

In both pin and cyclic sleep modes, XBee end devices poll their parent every 100ms while they are awake to retrieve buffered data. When the end device sends a poll request, it enables the receiver until it receives an acknowledgment from the parent. It typically takes less than 10ms between sending the poll request to receiving the acknowledgment. The acknowledgment indicates if the parent has buffered data for the end device child. If the acknowledgment indicates the parent has pending data, the end device leaves the receiver on to receive the data. Otherwise, the end device turns off the receiver and enter idle mode (until it sends the next poll request) to reduce current consumption (and improve battery life).

Once the device enters sleep mode, the On/Sleep pin (pin 26/SMT, pin13/TH) it de-asserts (low) to indicate the device is entering sleep mode. If the device enables CTS hardware flow control (D7 command), it de-asserts (high) the CTS pin (pin 25/SMT, pin 12/TH) when entering sleep to indicate that serial data should not be sent to the module.

If the Associate LED pin is configured (**D5** command), the associate pin is driven low to avoid using power to light the LED. Finally, the Sleep\_Rq pin is configured as a pulled-down input so that an external device must drive it high to wake the device. All other pins are left unmodified during sleep so that they can operate as previously configured by the user. The device does not respond to serial or RF data when it is sleeping.

Applications that must communicate serially to sleeping end devices are encouraged to observe CTS flow control.

When the device wakes from sleep, it asserts (high) the On/Sleep pin, and if it enables flow control, it also asserts (low) the CTS pin. The associate LED and all other pins resume their former configured operation. If the module has not joined a network, it scans all SC channels after waking to try and find a valid network to join.

### Pin sleep

Pin sleep allows the module to sleep and wake according to the state of the Sleep\_RQ pin (pin 10/SMT, pin 9/TH). SetPin sleep mode is enabled by setting the **SM** command to 1.

When the device asserts (high) Sleep\_RQ, it finishes any transmit or receive operations and enters a low power state. For example, if the device has not joined a network and Sleep\_RQ is asserted (high), it sleeps once the current join attempt completes (that is, when scanning for a valid network completes). The device wakes from pin sleep when the Sleep\_RQ pin is de-asserted (low). The following figures show the XBee sleep pins.

#### Surface-mount sleep pins

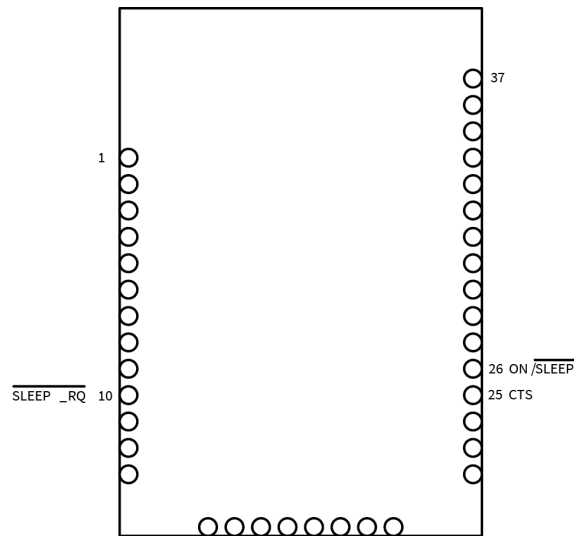

#### Through-hole sleep pins

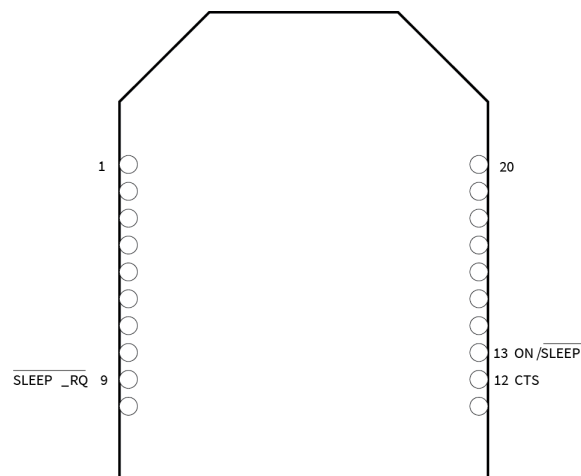

The following figure show the pin sleep waveforms:

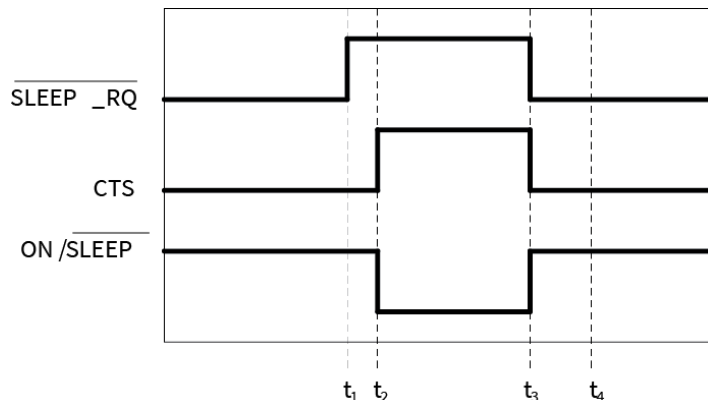

In the previous figure,  $t_1$ ,  $t_2$ ,  $t_3$  and  $t_4$  represent the following events:

- $t_1$  - Time when Sleep\_RQ is asserted (high)
- $t_2$  - Time when the XBee enters sleep ( $\overline{\text{CTS}}$  state change only if hardware flow control is enabled)
- $t_3$  - Time when Sleep\_RQ is de-asserted (low) and the module wakes
- $t_4$  - Time when the module sends a poll request to its parent

The time between  $t_1$  and  $t_2$  varies depending on the state of the module. In the worst case scenario, if the end device is trying to join a network, or if it is waiting for an acknowledgment from a data transmission, the delay could be up to a few seconds. The time between  $t_3$  and  $t_4$  is 1-2 ms for a regular device and about 6 ms for a PRO device.

When the XBee device is awake and is joined to a network, it sends a poll request to its parent to see if the parent has any buffered data. The end device continues to send poll requests every 100 ms while it is awake.

### Demonstration of pin sleep

Parent and remote devices must be configured to buffer data correctly and to use adequate transmission timeouts. For more information, see [Router/Coordinator configuration](#).

## Cyclic sleep

Cyclic sleep allows the device to sleep for a specified time and wake for a short time to poll its parent for any buffered data messages before returning to sleep again. Enable cyclic sleep mode by setting the **SM** command to 4 or 5. **SM5** is a slight variation of **SM4** that allows the device to wake up prematurely by asserting the Sleep\_RQ pin (pin 10/SMT, pin 9/TH). In **SM5**, the XBee device can wake after the sleep period expires, or if a high-to-low transition occurs on the Sleep\_RQ pin. Setting **SM** to 4 disables the pin wake option.

In cyclic sleep, the device sleeps for a specified time, and then wakes and sends a poll request to its parent to discover if the parent has any pending data for the end device. If the parent has buffered data for the end device, or if it receives serial data, the device remains awake for a time. Otherwise, it enters sleep mode immediately.

When the device wakes, it asserts (high) the On/Sleep line, and de-asserted (low) when the device sleeps. If you enable hardware flow control (**D7** command), the CTS pin asserts (low) when the device wakes and can receive serial data, and de-assert (high) when the device sleeps.

The following figure shows the XBee sleep pins.

**Surface-mount cyclic sleep pins**

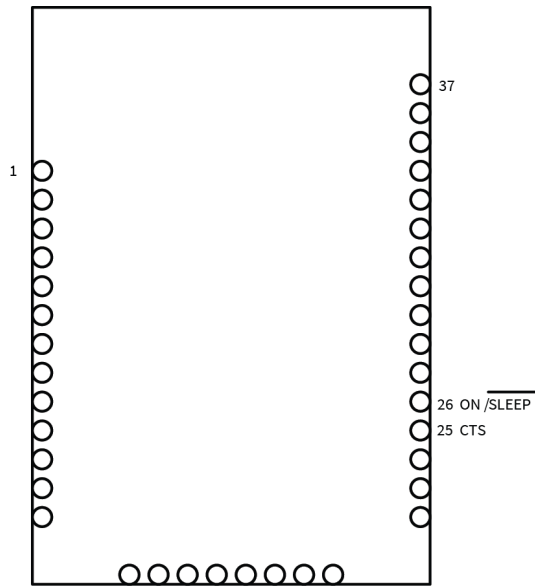

**S2C Through-hole cyclic sleep pins**

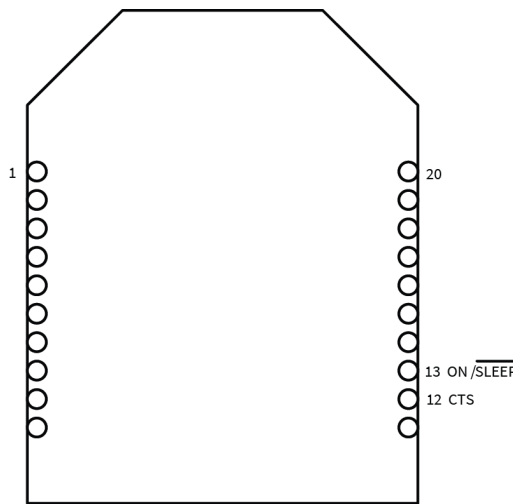

The following figure shows the cyclic sleep waveforms.



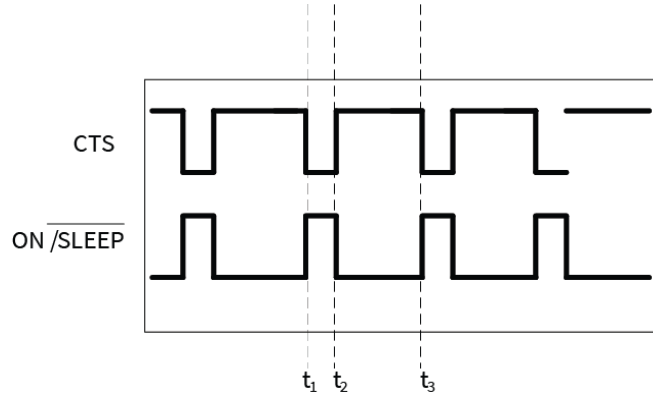

In the figure above, t1, t2, and t3 represent the following events:

- t1 - Time when the device wakes from cyclic sleep
- t2 - Time when the device returns to sleep
- t3 - Later time when the device wakes from cyclic sleep

The wake time and sleep time are configurable with software commands as described in the following section.

**Wake time (until sleep)**

In cyclic sleep mode (SM=4 or 5), if the device receives serial or RF data, it starts a sleep timer (time until sleep). Any data received serially or over the RF link restarts the timer. Set the sleep timer value with the ST command. While the module is awake, it sends poll request transmissions every 100ms to check its parent for buffered data messages. The device returns to sleep when the sleep timer expires, or if it receives the **SI** command as shown in the following image.

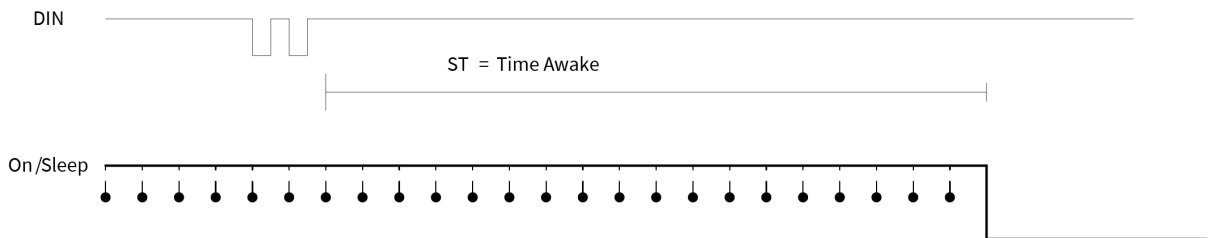

A cyclic sleep end device enters sleep mode when no serial or RF data is received for ST time.

- Legend
- On/Sleep —————
  - Transmitting Poll Request - - - - ●

**Sleep period**

Configure the sleep period based on the **SP**, **SN**, and **SO** commands. The following table lists the behavior of these commands.

Command	Range	Description
<b>SP</b>	0x20 - 0xAF0 (x 10 ms) (320 - 28,000 ms)	Configures the sleep period of the device.
<b>SN</b>	1 - 0xFFFF	Configures the number of sleep periods multiplier.
<b>SO</b>	0 - 0xFF	Defines options for sleep mode behavior. 0x02 - Always wake for full <b>ST</b> time 0x04 - Enable extended sleep (sleep for full ( <b>SP</b> * <b>SN</b> ) time)

The device supports both a [Short cyclic sleep](#) and an [Extended cyclic sleep](#) that make use of these commands. These two modes allow the sleep period to be configured according to the application requirements.

### Short cyclic sleep

In short cyclic sleep mode, define the sleep behavior of the device by the **SP** and **SN** commands, and the **SO** command must be set to 0x00 (default) or 0x02. In short cyclic sleep mode, the **SP** command defines the sleep period and you can set it for up to 28 seconds. When the XBee module enters short cyclic sleep, it remains in a low power state until the SP time has expired.

After the sleep period expires, the XBee module sends a poll request transmission to its parent to determine if the parent has any buffered data waiting for the end device. Since router and coordinator devices can buffer data for end device children up to 30 seconds, the **SP** range (up to 28 seconds) allows the end device to poll regularly enough to receive buffered data. If the parent has data for the end device, the end device starts its sleep timer (**ST**) and continues polling every 100ms to receive data. If the end device wakes and finds that its parent has no data for it, the end device can return to sleep immediately.

Use the **SN** command to control when the On/Sleep line is asserted (high). If you **SN** to 1 (default), the On/Sleep line sets high each time the XBee module wakes from sleep. Otherwise, if **SN** is greater than 1, the On/ Sleep line only sets high if RF data is received, or after **SN** wake cycles occur. This allows an external device to remain powered off until it receives RF data, or until a number of sleep periods have expired (**SN** sleep periods). This mechanism allows the XBee to wake at regular intervals to poll its parent for data without waking an external device for an extended time (SP \* SN time) as shown in the following figure.

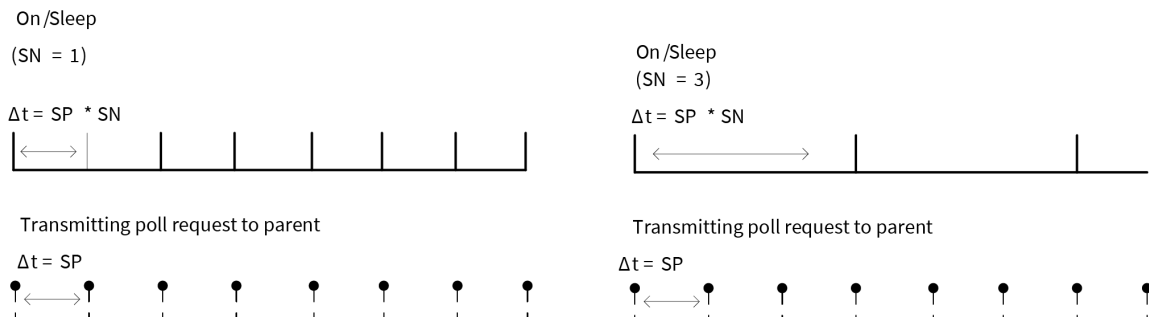

Setting SN > 1 allows the device to silently poll for data without asserting On/Sleep. If RF data is received when polling, On/Sleep will immediately assert.

**Note** **SP** controls the packet buffer time on routers and coordinators. Set **SP** on all router and coordinator devices to match the longest end device **SP** time. For more information, see [Router/Coordinator configuration](#).

### Extended cyclic sleep

In extended cyclic sleep operation, an end device can sleep for a multiple of **SP** time which can extend the sleep time up to several days. Configure the sleep period using the **SP** and **SN** commands. The total sleep period is equal to (**SP** \* **SN**) where **SP** is measured in 10ms units. The **SO** command must be set correctly to enable extended sleep.

Since routers and coordinators can only buffer incoming RF data for their end device children for up to 30 seconds, if an end device sleeps longer than 30 seconds, devices in the network need some indication when an end device is awake before they can send data to it. End devices that use extended cyclic sleep should send a transmission (such as an **I/O** sample) when they wake to inform other devices that they are awake and can receive data. We recommended that extended sleep end devices set **SO** to wake for the full **ST** time to provide other devices with enough time to send messages to the end device.

Similar to short cyclic sleep, end devices running in this mode return to sleep when the sleep timer expires, or when they receive the **SI** command.

### Deep sleep

The following are preconditions for maintaining low current draw during sleep:

- You must maintain the supply voltage within a valid operating range (2.1 to 3.6 V for the XBee, 3.0 to 3.6 V for the XBee-PRO (S2), 2.7 to 3. V for the XBee-PRO S2B).
- Each GPIO input line with a pullup resistor which is driven low draws about 100 uA current through the internal pullup resistor.
- If circuitry external to the XBee drives such input lines low, then the current draw rises above expected deep sleep levels.

- Each GPIO input line that has no pullup or pull-down resistor (is floating) has an indeterminate voltage which can change over time and temperature in an indeterminate manner.

## Recommended sleep current measurements

Properly measuring the sleep current helps to accurately estimate battery life requirements. To ensure that you take proper measurements without upsetting the normal operation of the unit under test, read the following steps.

When you measure sleep currents, it can cause problems with the devices because the equipment that measures very low currents accurately requires a large resistor in series with the power supply. This large resistor starves current from the device during a momentary wake cycle, forcing the voltage to drop to brownout levels rapidly. This voltage drop places the device in a state that may require a reset to resolve the problem.

### Achieve the lowest sleep current

To achieve the lowest sleep current, you must disable brownout detectors during sleep modes. Even if the measurement equipment automatically changes current ranges, it is often too slow and cannot keep up with the necessary sudden short bursts. During long cyclic sleep periods, the device can wake every 10 to 30 seconds to reset timers and perform other necessary steps. These wake times are small and you may not notice them when measuring sleep currents.

### Compensate for switching time

To compensate for the switching time of the equipment you must temporarily add an additional large cap when you need measurements to allow for short pulses of current draw (see the following schematic for details). A cap of 100 uF is enough to handle 1.5 milliseconds with 20 mA of current. You can increase or decrease the capacitor based on the switching time of the measurement circuitry and the momentary on time of the unit. Measure the leakage current of the additional cap to verify that it does not skew the low current reading. The capacitor averages the spike in current draw. The actual magnitude of the current spike is no longer visible, but you can account for the total energy consumed by integrating the current over time and multiplying by the voltage.

The sleep current may be less for an S2C than an S2D, because the S2D has more RAM to maintain during sleep (64K versus 12K RAM).

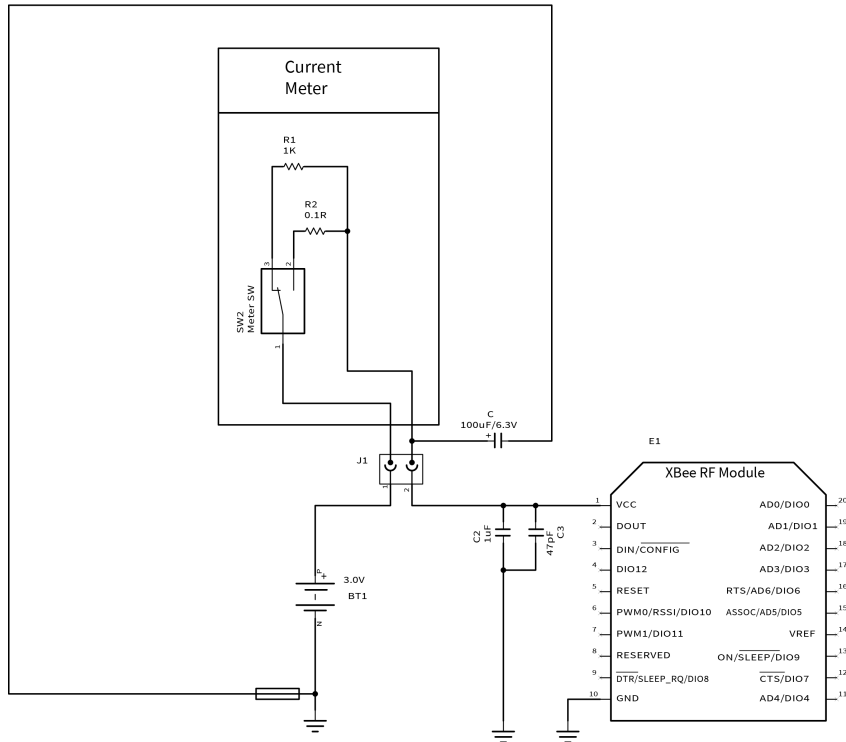

### Internal pin pull-ups

Internal pin pull-ups can pull excess current and cause the sleep current readings to be higher than desired if you drive or float the pull-ups.

- Disable all pull-ups for input lines that have a low driven state during sleep.
- Enable pull-ups for floating lines or inputs that do not connect to other circuitry.

If you use an analog-to-digital converter (ADC) to read the analog voltage of a pin, it may not be possible to stop all leakage current unless you can disconnect the voltage during sleep. Each floating input that is not at a valid high or low level can cause leakage depending on the temperature and charge buildup that you may not observe at room temperature.

### Transmitting RF data

An end device may transmit data when it wakes from sleep and has joined a network. End devices transmit directly to their parent and then wait for an acknowledgment to be received. The parent performs any required address and route discoveries to help ensure the packet reaches the intended destination before reporting the transmission status to the end device.

### Receiving RF data

After waking from sleep, an end device sends a poll request to its parent to determine if the parent has any buffered data for it. In pin sleep mode, the end device polls every 100ms while the Sleep\_RQ pin is de-asserted (low). In cyclic sleep mode, the end device will only poll once before returning to sleep unless the sleep timer (**ST**) is started (serial or RF data is received). If the sleep timer is started, the end device will continue to poll every 100 ms until the sleep timer expires.

This firmware includes an adaptive polling enhancement where, if an end device receives RF data from its parent, it sends another poll after a very short delay to check for more data. The end device continues to poll at a faster rate as long as it receives data from its parent. This feature greatly improves data throughput to end devices. When the end device no longer receives data from its parent, it resumes polling every 100 ms.

## I/O sampling

End devices can be configured to send one or more I/O samples when they wake from sleep. To enable I/O sampling on an end device, the **IR** command must be set to a non-zero value, and at least one analog or digital I/O pin must be enabled for sampling (**D0 - D9**, **P0 - P4** commands). If I/O sampling is enabled, an end device sends an I/O sample when it wakes and starts the **ST** timer. It will continue sampling at the **IR** rate until the sleep timer (**ST**) has expired. For more information, see [Analog and digital I/O lines](#).

## Waking end devices with the Commissioning Pushbutton

If you enable the Commissioning pushbutton functionality (**D0** command), a high-to-low transition on the AD0/ DIO0 pin (pin 33) causes an end device to wake for 30 seconds. For more information, see [Commissioning pushbutton and associate LED](#).

## Parent verification

Since an end device relies on its parent to maintain connectivity with other devices in the network, XBee end devices include provisions to verify the connection with its parent. End devices monitor the link with their parent when sending poll messages and after a power cycle or reset event as described below.

When an end device wakes from sleep, it sends a poll request to its parent. In cyclic sleep, if the end device does not receive RF or serial data and the sleep timer is not started, it polls one time and returns to sleep for another sleep period. Otherwise, the end device continues polling every 100ms. If the parent does not send an acknowledgment response to three consecutive poll request transmissions, the end device assumes the parent is out of range, and attempts to find a new parent.

After a power-up or reset event, the end device does an orphan scan to locate its parent. If the parent does not send a response to the orphan scan, the end device attempts to find a new parent.

## Rejoining

Once all devices have joined a ZigBee network, disable the permit-joining attribute disabled such that new devices are no longer allowed to join the network. You can enable permit-joining later as needed for short times. This provides some protection in preventing other devices from joining a live network.

If an end device cannot communicate with its parent, the end device must be able to join a new parent to maintain network connectivity. However, if permit-joining is disabled in the network, the end device will not find a device that is allowing new joins.

To overcome this problem, ZigBee supports rejoining, where an end device can obtain a new parent in the same network even if joining is not enabled. When an end device joins using rejoining, it performs a PAN ID scan to discover nearby networks. If a network is discovered that has the same 64-bit PAN ID as the end device, it joins the network by sending a rejoin request to one of the discovered devices. The device that receives the rejoin request sends a rejoin response if it can allow the device to join the network (that is, the child table is not full). You can use the rejoin mechanism to allow a device to join the same network even if permit-joining is disabled.

To enable rejoining, set **NJ** to less than 0xFF on the device joining. If  $NJ < 0xFF$ , the device assumes the network is not allowing joining and first tries to join a network using rejoining. If multiple rejoining attempts fail, or if  $NJ=0xFF$ , the device attempts to join using association.

## Router/Coordinator configuration

XBee routers and coordinators may require some configuration to ensure the following are set correctly.

- RF Packet buffering timeout
- Child poll timeout
- Transmission timeout

The value of these timeouts depends on the sleep time used by the end devices.

### RF packet buffering timeout

When a router or coordinator receives an RF data packet intended for one of its end device children, it buffers the packet until the end device wakes and polls for the data, or until a packet buffering timeout occurs. Use the **SP** command to set the timeout. The actual timeout is  $(1.2 * SP)$ , with a minimum timeout of 1.2 seconds and a maximum of 30 seconds. Since the packet buffering timeout is set slightly larger than the **SP** setting, set **SP** the same on routers and coordinators as it is on cyclic sleep end devices. For pin sleep devices, set **SP** as long as the pin sleep device can sleep, up to 30 seconds.

---

**Note** In pin sleep and extended cyclic sleep, end devices can sleep longer than 30 seconds. If end devices sleep longer than 30 seconds, parent and non-parent devices must know when the end device is awake in order to reliably send data. For applications that require sleeping longer than 30 seconds, end devices should transmit an **I/O** sample or other data when they wake to alert other devices that they can send data to the end device.

---

### Child poll timeout

Router and coordinator devices maintain a timestamp for each end device child indicating when the end device sent its last poll request to check for buffered data packets. If an end device does not send a poll request to its parent for a certain period of time, the parent assumes the end device has moved out of range and removes the end device from its child table. This allows routers and coordinators to be responsive to changing network conditions. You can issue the **NC** command at any time to read the number of remaining (unused) child table entries on a router or coordinator.

Set the child poll timeout with the **SP** and **SN** commands. **SP** and **SN** should be set such that  $SP * SN$  matches the longest expected sleep time of any end devices in the network. The device calculates the actual timeout as  $(3 * SP * SN)$ , with a minimum of 5 seconds. For networks consisting of pin sleep end devices, set the **SP** and **SN** values on the coordinator and routers so the  $SP * SN$  matches the longest expected sleep period of any pin sleep device. The 3 multiplier ensures the end device will not be removed unless 3 sleep cycles pass without receiving a poll request. You can set the poll timeout up to two months.

### Adaptive polling

The **PO** command determines the regular polling rate. However, if RF data has been recently received by an end device, it is likely that more RF data could be on the way. Therefore, the end device polls at a faster rate, gradually decreasing its adaptive poll rate until polling resumes at the regular rate as defined by the **PO** command.

## Transmission timeout

When you are sending RF data to a remote router, because routers are always on, the timeout is based on the number of hops the transmission may traverse. Set the timeout using the **NH** command. For more information, see [Transmission, addressing, and routing](#).



Since end devices may sleep for lengthy periods of time, the transmission timeout to end devices also allows for the sleep period of the end device. When sending data to a remote end device, the transmission timeout is calculated using the **SP** and **NH** commands. If the timeout occurs with no acknowledgment received, the source device re-sends the transmission until it receives an acknowledgment, up to two more times.

The transmission timeout per attempt is:

$3 * ((\text{unicast router timeout}) + (\text{end device sleep time}))$

$3 * ((50 * \text{NH}) + (1.2 * \text{SP}))$ , where **SP** is measured in 10ms units.

## Putting it all together

### Short sleep periods

Pin and cyclic sleep devices that sleep less than 30 seconds can receive data transmissions at any time since their parent devices are able to buffer data long enough for the end devices to wake and poll to receive the data. Set **SP** the same on all devices in the network. If end devices in a network have more than one **SP** setting, set **SP** on the routers and coordinators to match the largest **SP** setting of any end device. This ensure the RF packet buffering, poll timeout, and transmission timeouts are set correctly.

### Extended sleep periods

Pin and cyclic sleep devices that might sleep longer than 30 seconds cannot receive data transmissions reliably unless you take certain design approaches. Specifically, the end devices should use I/O sampling or another mechanism to transmit data when they wake to inform the network they can receive data. **SP** and **SN** should be set on routers and coordinators such that  $(\text{SP} * \text{SN})$  matches the longest expected sleep time. This configures the poll timeout so end devices are not expired from the child table unless routers and coordinators do not receive a poll request for 3 consecutive sleep periods.

As a general rule, **SP** and **SN** should be set the same on all devices in almost all cases.

### Sleep examples

This section covers some sample XBee configurations to support different sleep modes. Several AT commands are listed with suggested parameter values.

In AT command mode, issue each command with a leading 'AT' and no '=' sign, for example, ATSM4. In the API, the two byte command is used in the command field, and parameters are populated as binary values in the parameter field.

#### **Example 1: Configure a device to sleep for 20 seconds, but set SN such that the On/sleep line will remain de-asserted for up to 1 minute.**

The following settings should be configured on the end device.

- **SM** = 4 (cyclic sleep) or 5 (cyclic sleep, pin wake)
- **SP** = 0x7D0 (2000 decimal). This causes the end device to sleep for 20 seconds since **SP** is measured in units of 10ms.
- **SN** = 3. (With this setting, the On/Sleep pin asserts once every 3 sleep cycles, or when it receives RF data) SO = 0

Set all router and coordinator devices on the network **SP** to match **SP** on the end device. This sets the RF packet buffering times and transmission timeouts correctly.

Since the end device wakes after each sleep period (**SP**), you can set the **SN** command to 1 on all routers and the coordinator.

**Example 2: Configure an end device to sleep for 20 seconds, send 4 I/O samples in 2 seconds, and return to sleep.**

Because **SP** is measured in 10ms units, and **ST** and **IR** are measured in 1ms units, configure an end device with the following settings:

- **SM** = 4 (cyclic sleep) or 5 (cyclic sleep, pin wake)
- **SP** = 0x7D0 (2000 decimal). This causes the end device to sleep for 20 seconds.
- **SN** = 1
- **SO** = 0
- **ST** = 0x7D0 (2000 decimal). This sets the sleep timer to 2 seconds.
- **IR** = 0x258 (600 decimal). Set **IR** to a value greater than (2 seconds / 4) to get 4 samples in 2 seconds. The end device sends an I/O sample at the **IR** rate until the sleep timer has expired.

You must enable at least one analog or digital I/O line for I/O sampling to work. To enable pin 32 (AD1/DIO1) as a digital input line, you must set the following:

D1 = 3

Set all router and coordinator devices on the network **SP** to match **SP** on the end device. This ensures that RF packet buffering times and transmission timeouts are set correctly.

**Example 3: configure a device for extended sleep: to sleep for 4 minutes.**

- **SP** and **SN** must be set such that  $SP * SN = 4$  minutes. Since **SP** is measured in 10ms units, use the following settings to obtain 4 minute sleep.
- **SM** = 4 (cyclic sleep) or 5 (cyclic sleep, pin wake) **SP** = 0x7D0 (2000 decimal, or 20 seconds)
- **SN** = 0x0B (12 decimal)
- **SO** = 0x04 (enable extended sleep)

With these settings, the module sleeps for  $SP * SN$  time, or (20 seconds \* 12) = 240 seconds = 4 minutes.

For best results, the end device should send a transmission when it wakes to inform the coordinator (or network) when it wakes. It should also remain awake for a short time to allow devices to send data to it. The following are recommended settings.

- **ST** = 0x7D0 (2 second wake time)
- **SO** = 0x06 (enable extended sleep and wake for ST time)
- **IR** = 0x800 (send 1 I/O sample after waking). Enable at least one analog or digital I/O sample enabled for I/O sampling.

With these settings, the end device wakes after 4 minutes and sends 1 I/O sample. It then remains awake for 2 seconds before returning to sleep.

Set **SP** and **SN** to the same values on all routers and coordinators that could potentially allow the end device to join. This ensures the parent does not timeout the end device from its child table too quickly.

The **SI** command can optionally be sent to the end device to cause it to sleep before the sleep timer expires.

## Analog and digital I/O lines

---

XBee ZB firmware supports a number of analog and digital I/O pins that are configured through software commands. Analog and digital I/O lines can be set or queried.

Configurable I/O pins and configuration commands .....	140
I/O Configuration .....	141
I/O sampling .....	142
RSSI PWM .....	144
PWM1 .....	145

## Configurable I/O pins and configuration commands

The following tables list the configurable I/O pins and the corresponding configuration commands.

Module Pin Names	Module Pin	AT Command	Command Range
DOUT/DIO13	3	<b>P3</b>	0, 1, 3-5
DIN/ $\overline{\text{CONFIG}}$ /DIO14	4	<b>P4</b>	0, 1, 3-5
RSSI PWM/DIO10	7	<b>P0</b>	0, 1, 3-5
PWM1/DIO11	8	<b>P1</b>	0, 1, 3-5
$\overline{\text{DTR}}$ /SLEEP_RQ /DIO8	10	<b>D8</b>	0, 1, 3-5
SPI_ATT $\overline{\text{N}}$ / BOOTMODE/DIO19	12	<b>P9</b>	0, 1, 6
SPI_SCK/DIO18	14	<b>P8</b>	0, 1
SPI_S $\overline{\text{SE}}$ /DIO17	15	<b>P7</b>	0, 1
SPI_MOSI/DIO16	16	<b>P6</b>	0, 1
SPI_MISO/DIO15	17	<b>P5</b>	0, 1
[reserved]*	21	<b>P2</b>	0, 3-5
DIO4	24	<b>D4</b>	0, 3-5
$\overline{\text{CTS}}$ /DIO7	25	<b>D7</b>	0, 1, 3-7
ON/SLEEP/DIO9	26	<b>D9</b>	0, 1, 3-5
ASSOCIATE/DIO5	28	<b>D5</b>	0, 1, 3-5
RTS/DIO6	29	<b>D6</b>	0, 1, 3-5
AD3/DIO3	30	<b>D3</b>	0, 2-5
AD2/DIO2	31	<b>D2</b>	0, 2-5
AD1/DIO1	32	<b>D1</b>	0, 2-6
AD0/DIO0	33	<b>D0</b>	0-5

### XBee ZB through-hole RF module

Module Pin Names	Module Pin	AT Command	Command Range
DIO13/DOUT	2	<b>P3</b>	0, 1, 3-5
DIO14/DIN/ $\overline{\text{CONFIG}}$	3	<b>P4</b>	0, 1, 3-5
DIO12/PWM2/SWDIO/SPI_MISO	4	<b>P2</b>	
DIO10/PWM RSSI/DAC0	6	<b>P0</b>	0, 1, 3-5

Module Pin Names	Module Pin	AT Command	Command Range
DIO11/PWM1/DAC1	7	<b>P1</b>	0, 1, 3-5
DIO8/ $\overline{\text{DTR}}$ /SLP_RQ	9	<b>D8</b>	0, 1, 3-5
DIO4/SPI_MOSI	11	<b>D4</b>	0, 1, 3-5
DIO7/ $\overline{\text{CTS}}$	12	<b>D7</b>	0, 1, 3-7
DIO9/On/ $\overline{\text{SLEEP}}$ /SWO	13	<b>D9</b>	0, 1, 3-5
DIO5/ASSOC/JTDI	15	<b>D5</b>	0, 1, 3-5
DIO6/ $\overline{\text{RTS}}$	16	<b>D6</b>	0, 1, 3-5
DIO3/AD3/SPI_ $\overline{\text{SSEL}}$	17	<b>D3</b>	0-5
DIO2/AD2/SPI_SCLK	18	<b>D2</b>	0-5
DIO1/AD1/SPI_ $\overline{\text{ATTN}}$	19	<b>D1</b>	0-6
DIO0/AD0/CommBtn	20	<b>D0</b>	0-5

## I/O Configuration

To enable an analog or digital I/O function on one or more XBee device pins, you must issue the appropriate configuration command with the correct parameter. After issuing the configuration command, you must apply changes on the device for the I/O settings to take effect.

Pin Command Parameter	Description
0	Disabled (see the information following the table)
1	Peripheral control
2	Analog
3	Data in monitored (see the information following the table)
4	Data out default low
5	Data out default high
6	RS485 enable low / packet trace interface
7	RS485 enable high
>7	Unsupported

When the pin command parameter is a 0 or a 3, it operates the same on this platform, except the device does not monitor the pin by I/O sampling if the parameter is 0.

Inputs have three variations:

- floating
- pulled-up
- pulled-down

A floating input is appropriate if the pin is attached to an output that always drives the line. In this case, a pull-up or pull-down resistor draws more current.

A pulled-up input is useful where there might not always be an external source to drive the pin and it is desirable to have the line read high in the absence of an external driver.

Likewise, a pulled-down input is useful when there is not always an external source to drive the pin and it is desirable to have the line read low in the absence of an external driver.

Two commands are available to configure the input type:

- **PR** determines whether or not to pull an input. If the corresponding bit in **PR** is set, the signal pulls. If it is clear, then the signal floats.
- **PD** determines the pull direction. It only applies when the corresponding bit in **PR** is set. Set the bit in **PD** to enable an internal pull-up resistor; clear it to enable an internal pull-down resistor.

## I/O sampling

The XBee ZB devices have the ability to monitor and sample the analog and digital I/O lines. I/O samples can be read locally or transmitted to a remote device to provide an indication of the current I/O line states. You must enable API mode on the receiving device to send I/O samples out the serial port. If you do not enable this mode, the device discards the remote I/O samples.

There are three ways to obtain I/O samples, either locally or remotely:

- Queried Sampling
- Periodic Sampling
- Change Detection Sampling

I/O sample data is formatted as shown in the following table:

Bytes	Name	Description
1	Sample Sets	Number of sample sets in the packet. (Always set to 1.)
2	Digital Channel Mask	Indicates which digital I/O lines have sampling enabled. Each bit corresponds to one digital I/O line on the module.  bit 0 = AD0/DIO0 bit 1 = AD1/DIO1 bit 2 = AD2/DIO2 bit 3 = AD3/DIO3 bit 4 = DIO4 bit 5 = ASSOC/DIO5 bit 6 = RTS/DIO6 bit 7 = CTS/GPIO7 bit 8 = SLP_RQ/DIO8 bit 9 = ON_SLP/DIO9 bit 10 = RSSI/DIO10 bit 11 = PWM/DIO11 bit 12 = CD/DIO12 bit 13 = DOUT/DIO13 bit 14 = DIN/DIO14 For example, a digital channel mask of 0x002F means DIO0,1,2,3, and 5 are enabled as digital I/O.

Bytes	Name	Description
1	Analog Channel Mask	Indicates which lines have analog inputs enabled for sampling. Each bit in the analog channel mask corresponds to one analog input channel. bit 0 = AD0/DIO0 bit 1 = AD1/DIO1 bit 2 = AD2/DIO2 bit 3 = AD3/DIO3 bit 7 = Supply Voltage
Variable	Sampled Data Set	A sample set consisting of 1 sample for each enabled ADC and/or DIO channel, which has voltage inputs of 1143.75 and 342.1875 mV.  If any digital I/O lines are enabled, the first two bytes of the data set indicate the state of all enabled digital I/O. Only digital channels that are enabled in the Digital Channel Mask bytes have any meaning in the sample set. If no digital I/O are enabled on the device, these 2 bytes will be omitted.  Following the digital I/O data (if any), each enabled analog channel returns 2 bytes. The data starts with AIN0 and continues sequentially for each enabled analog input channel up to AIN3, and the supply voltage (if enabled) at the end.

The sampled data set includes 2 bytes of digital I/O data only if one or more I/O lines on the device are configured as digital I/O. If no pins are configured as digital I/O, these 2 bytes are omitted. Pins are configured as digital I/O by setting them to a value of 3, 4, or 5.

The digital I/O data is only relevant if the same bit is enabled in the digital I/O mask.

Analog samples are returned as 10-bit values. The device scales the analog reading such that 0x0000 represents 0 V, and 0x3FF = 1.2 V (The analog inputs on the device cannot read more than 1.2 V.). The device returns analog samples in order starting with AIN0 and finishing with AIN3, and the supply voltage. Only enabled analog input channels return data.

To convert the A/D reading to mV, do the following:

$$AD(mV) = (A/D \text{ reading} * 1200mV) / 1023$$

The reading in the sample frame represents voltage inputs of 1143.75 and 342.1875 mV for AD0 and AD1 respectively.

### Queried sampling

You can send the **IS** command to a device locally, or to a remote device using the API remote command frame (for more information, see [API Operation](#)). When you send the **IS** command, the receiving device samples all enable digital I/O and analog input channels and return an I/O sample. If you send the **IS** locally, the device sends the I/O sample out the serial port. If the **IS** command was received as a remote command, the I/O sample is sent over-the-air to the device that sent the **IS** command.

If you issue the **IS** command in command mode, the device returns a carriage return-delimited list containing the fields listed in [I/O sampling](#). If you issue the **IS** command in API mode, an API command response contains the same information.

The following table shows an example of the fields in an **IS** response.

Example	Sample AT Response
0x01	[1 sample set]
0x0C0C	[Digital Inputs: DIO 2, 3, 10, 11 enabled]
0x03	[Analog Inputs: A/D 0, 1 enabled]
0x0408	[Digital input states: DIO 3, 10 high, DIO 2, 11 low]
0x03D0	[Analog input ADIO 0= 0x3D0]
0x0124	[Analog input ADIO 1=0x120]

## Periodic I/O sampling

Periodic sampling allows a device to take an I/O sample and transmit it to a remote device at a periodic rate. Use the **IR** command to set the periodic sample rate.

- To disable periodic sampling, set **IR** to 0.
- For all other **IR** values, the firmware samples data when **IR** milliseconds elapse and the sample data transmits to a remote device.

The **DH** and **DL** commands determine the destination address of the I/O samples.

You can set **DH** and **DL** to 0 to transmit to the coordinator, or to the 64-bit address of the remote device (**SH** and **SL**).

Only devices with API operating mode enabled send I/O data samples out their serial interface. Devices that are in Transparent mode (**AP** = 0) discard the I/O data samples they receive. You must configure at least one pin as a digital or ADC input to generate sample data.

A device with sleep enabled transmits periodic I/O samples at the **IR** rate until the **ST** time expires and the device can resume sleeping.

## Change detection sampling

You can configure devices to transmit a data sample immediately whenever a monitored digital I/O pin changes state. The **IC** command is a bitmask used to set which digital I/O lines to monitor for a state change. If one or more bits in **IC** is set, the device transmits an I/O sample as soon as it observes a state change in one of the monitored digital I/O lines. Use **DH** and **DL** to specify the 64-bit address to transmit change detection samples.

## RSSI PWM

The XBee module features an RSSI/PWM pin (pin 7/SMT, pin 6/TH) that, if enabled, adjusts the PWM output to indicate the signal strength of the last received packet. Use the **P0** (P-zero) command to enable the RSSI pulse width modulation (PWM) output on the pin. If **P0** is set to 1 (and **P1** is not set to 1), the RSSI/PWM pin outputs a pulse width modulated signal where the frequency adjusts based on the received signal strength of the last packet. Otherwise, for all other **P0** settings, use the pin for general purpose **IO**.

When a data packet is received, if you set **P0** to enable the RSSI/PWM feature, the RSSI PWM output adjusts based on the RSSI of the last packet. The RSSI/PWM output is enabled for a time based on the **RP** command. Each time the device receives an RF packet, the RSSI/PWM output adjusts based on the RSSI of the new packet, and resets the RSSI timer. If the RSSI timer expires, the RSSI/PWM pin drives low. **RP** is measured in 100ms units and defaults to a value of 40 (4 seconds).



The RSSI PWM runs at 12MHz and has 2400 total counts (200us period). RSSI (in dBm) is converted to PWM counts using the following equation:

$$\text{PWM counts} = (41 * \text{RSSI\_Unsigned}) - 5928$$

## I/O examples

### **Example 1: Configure the following I/O settings on the XBee**

Configure AD1/DIO1 as a digital input with pullup resistor enabled Configure AD2/DIO2 as an analog input

Configure DIO4 as a digital output, driving high.

To configure AD1/DIO1 as an input, issue the **D1** command with a parameter of 3 (“ATD13”). To enable pull-up resistors on the same pin, issues the **PR** command with bit 3 set (for example, PR8, PR1FFF, and so on).

Issue the **D2** command with a parameter of 2 to enable the analog input (“D22”). Finally, set DIO4 as an output, driving high by issuing the **D4** command with a parameter value of 5 (“D45”).

After issuing these commands, apply the changes before the module I/O pins update to the new states. Issue the **AC** or **CN** commands to apply changes (for example, AC).

### **Example 2: Calculate the PWM counts for a packet received with an RSSI of -84 dBm**

- RSSI = -84 = 0xAC = 172 decimal (unsigned)
- PWM counts = (41 \* 172) - 5928
- PWM counts = 1124

With a total of 2400 counts, this yields an ON time of (1124 / 2400) = 46.8%

### **Example 3: Configure the RSSI/PWM pin to operate for 2 seconds after each received RF packet**

First, make sure the RSSI/PWM functionality is enabled by reading the **P0** (P-zero) command. It should be set to 1 (default).

To configure the duration of the RSSI/PWM output, set the **RP** command. To achieve a 2 second PWM output, set **RP** to 0x14 (20 decimal, or 2 seconds) and apply changes using the **AC** command.

After applying changes, all received RF data packets set the RSSI timer for 2 seconds.

## PWM1

When you configure **P1** for peripheral operation by setting the value to 1, it outputs a 50% duty cycle PWM with a clock rate of 32,787 Hz, which is a period of 30.5µs. The PWM output provides a clock for the PLUS processor, although it may also be used for other purposes.

When you enable this feature, the RSSI PWM output is automatically disabled, even if it is configured.

## API Operation

---

An alternative to Transparent Operation are Application Programming Interface (API) Operations. API operation requires that the device communicate through a structured interface (that is, data is communicated in frames in a defined order). The API specifies how the device sends and receives commands, command responses, and module status messages using a serial port Data Frame.

API frame format .....	147
Data bytes that need to be escaped: .....	148
API serial port exchanges .....	150
Frame descriptions .....	153
Send ZDO commands with the API .....	201
Send ZigBee Cluster Library (ZCL) commands with the API .....	204
Send Public Profile Commands with the API .....	209

## API frame format

The firmware supports two API operating modes: without escaped characters and with escaped characters. Use the AP command to enable either mode. To configure a device to one of these modes, set the following AP parameter values:

- **AP = 1:** API operation.
- **AP = 2:** API operation (with escaped characters—only possible on UART).

The API data frame structure differs depending on what mode you choose.

### API operation (AP parameter = 1)

The following table shows the data frame structure when you enable **AP = 1**:

Frame fields	Byte	Description
Start delimiter	1	0x7E
Length	2 - 3	Most Significant Byte, Least Significant Byte
Frame data	4 - n	API-specific structure
Checksum	n + 1	1 byte

The firmware silently discards any data it receives prior to the start delimiter. If the device does not receive the frame correctly or if the checksum fails, the device replies with a device status frame indicating the nature of the failure.

### API operation-with escaped characters (AP parameter = 2)

This mode is only available on the UART, not on the SPI serial port. The following table shows the data frame structure when you enable **AP = 2**:

Frame fields	Byte	Description
Start delimiter	1	0x7E
Length	2 - 3	Most Significant Byte, Least Significant Byte
Frame data	4 - n	API-specific structure
Checksum	n + 1	1 byte

#### Escape characters

When you are sending or receiving a UART data frame, specific data values must be escaped (flagged) so they do not interfere with the data frame sequencing. To escape an interfering data byte, insert 0x7D and follow it with the byte to be escaped XOR'd with 0x20.

## Data bytes that need to be escaped:

Byte	Description
0x7E	Frame Delimiter
0x7D	Escape
0x11	XON
0x13	XOFF

### Example: Raw serial data before escaping interfering bytes:

0x7E 0x00 0x02 0x23 0x11 0xCB

0x11 needs to be escaped which results in the following frame:

0x7E 0x00 0x02 0x23 0x7D 0x31 0xCB

**Note** In the previous example, the length of the raw data (excluding the checksum) is 0x0002 and the checksum of the non-escaped data (excluding frame delimiter and length) is calculated as:  $0xFF - (0x23 + 0x11) = (0xFF - 0x34) = 0xCB$ .

## Length

The length field specifies the total number of bytes included in the frame's data field. Its two-byte value excludes the start delimiter, the length, and the checksum.

## Frame data

This field contains the information that a device receives or transmits. The structure of frame data depends on the purpose of the API frame:

Start delimiter	Length		Frame data								Checksum
			API identifier	Identifier-specific Data							
1	2	3	4	5	6	7	8	9	...	n	n+1
0x7E	MSB	LSB	cmdID	cmdData							Single byte

The cmdID frame (API-identifier) indicates which API messages contains the cmdData frame (Identifier-specific data). The device sends multi-byte values big endian format.

The XBee/XBee-PRO ZigBee RF Module supports the following API frames:

API frame names	API ID
AT Command	0x08
AT Command - Queue Parameter Value	0x09

API frame names	API ID
ZigBee Transmit Request	0x10
Explicit Addressing ZigBee Command Frame	0x11
Remote Command Request	0x17
Create Source Route	0x21
AT Command Response	0x88
Modem Status	0x8A
ZigBee Transmit Status	0x8B
ZigBee Receive Packet (AO=0)	0x90
ZigBee Explicit Rx Indicator (AO=1)	0x91
ZigBee I/O Data Sample Rx Indicator	0x92
XBee Sensor Read Indicator (AO=0)	0x94
Node Identification Indicator (AO=0)	0x95
Remote Command Response	0x97
Extended Modem Status	0x98
Over-the-Air Firmware Update Status	0xA0
Route Record Indicator	0xA1
Many-to-One Route Request Indicator	0xA3

## Calculate and verify checksums

To test data integrity, the device calculates and verifies a checksum on non-escaped data.

To calculate the checksum of an API frame:

1. Add all bytes of the packet, except the start delimiter 0x7E and the length (the second and third bytes).
2. Keep only the lowest 8 bits from the result.
3. Subtract this quantity from 0xFF.

To verify the checksum of an API frame:

1. Add all bytes including the checksum; do not include the delimiter and length.
2. If the checksum is correct, the last two digits on the far right of the sum equal 0xFF.

## API examples

**Example: Create an API AT command frame to configure an XBee to allow joining (set NJ to 0xFF).**

The frame should look like:

0x7E 0x00 0x05 0x08 0x01 0x4E 0x4A 0xFF 5F

Where

- 0x0005 = length
- 0x08 = AT Command API frame type
- 0x01 = Frame ID (set to non-zero value)
- 0x4E4A = AT Command ('NJ')
- 0xFF = value to set command to
- 0x5F = Checksum

The checksum is calculated as  $[0xFF - (0x08 + 0x01 + 0x4E + 0x4A + 0xFF)]$

**Example: Send an ND command to discover the devices in the PAN.**

The frame should look like:

0x7E 0x00 0x04 0x08 0x01 0x4E 0x44 0x64

Where:

- 0x0004 = length
- 0x08 = AT Command API frame type
- 0x01 = Frame ID (set to non-zero value)
- 0x4E44 = AT command ('ND')
- 0x64 = Checksum

The checksum is calculated as  $[0xFF - (0x08 + 0x01 + 0x4E + 0x44)]$

**Example: Send a remote command to the coordinator to set AD1/DIO1 as a digital input (D1=3) and apply changes to force the I/O update.**

The API remote command frame should look like:

0x7E 0x00 0x10 0x17 0x01 0x00 0x00 0x00 0x00 0x00 0x00 0x00 0x00 0xFF 0xFE 0x02 0x44 0x31 0x03 0x70

Where:

- 0x10 = length (16 bytes excluding checksum)
- 0x17 = Remote Command API frame type
- 0x01 = Frame ID
- 0x0000000000000000 = Coordinator's address (can be replaced with coordinator's actual 64-bit address if known)
- 0xFFFFE = 16-bit Destination Address
- 0x02 = Apply Changes (Remote Command Options)
- 0x4431 = AT command ('D1')
- 0x03 = Command Parameter (the parameter could also be sent as 0x0003 or 0x00000003)
- 0x70 = Checksum

## API serial port exchanges

You can use the Frame ID field to correlate between the outgoing frames and associated responses.

### AT commands

The following image shows the API frame exchange that takes place at the serial interface when sending an AT command request to read or set a device parameter. You can disable the response by setting the frame ID to 0 in the request.

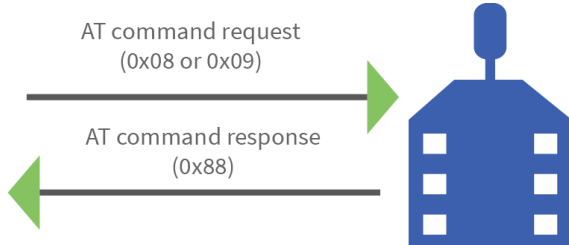

### Transmit and Receive RF data

The following image shows the API frames exchange that take place at the UART interface when sending RF data to another device. The transmit status frame is always sent at the end of a data transmission unless the frame ID is set to 0 in the TX request. If the packet cannot be delivered to the destination, the transmit status frame indicates the cause of failure. The received data frame type (0x90 or 0x91) is determined by the **AO** command.



### Remote AT commands

The following image shows the API frame exchanges that take place at the serial interface when sending a remote AT command. The device does not send out a remote command response frame through the serial interface if the remote device does not receive the remote command.

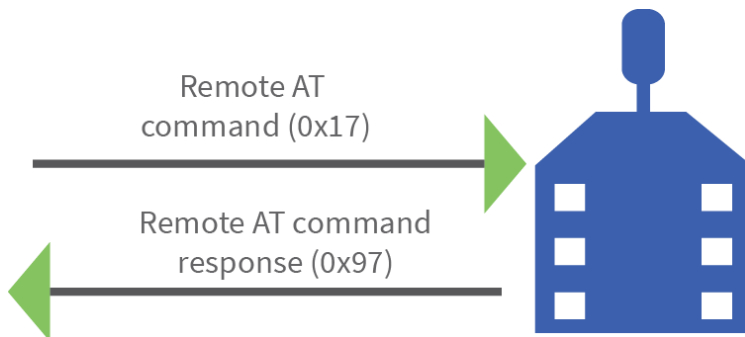

## Source routing

The following image shows the API frame exchanges that take place at the serial port when sending a source routed transmission.

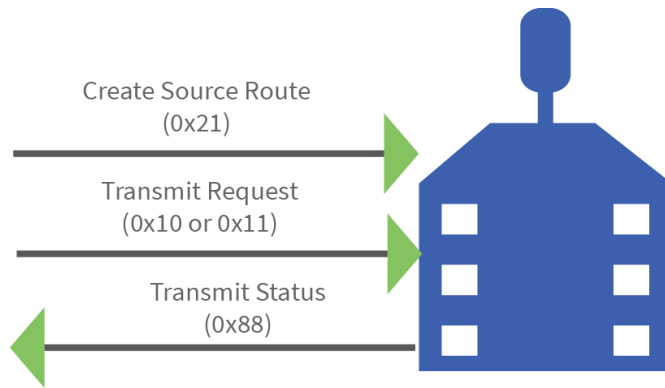



## Frame descriptions

The following sections illustrate the type of frames encountered while using the API.

## AT Command frame - 0x08

### Description

Use this frame to query or set device parameters on the local device. This API command applies changes after running the command. You can query parameter values by sending the 0x08 AT Command frame with no parameter value field (the two-byte AT command is immediately followed by the frame checksum).

### Format

The following table provides the contents of the frame. For details on frame structure, see [API frame format](#).

Frame data fields	Offset	Description
Frame type	3	0x08
Frame ID	4	
AT command	5-6	Command name: two ASCII characters that identify the AT command.
Parameter value	7-n	If present, indicates the requested parameter value to set the given register. If no characters are present, it queries the register.

The following example illustrates an AT Command frame when you modify the device's **NJ** parameter value.

Frame data fields	Offset	Example
Start delimiter	0	0x7E
Length	MSB 1	0x00
Frame type	3	0x08
Frame ID	4	0x52 (R)
AT command	5	0x4E (N)
	6	0x4A (J)
Parameter value (optional)		
Checksum	7	0x0D

## AT Command - Queue Parameter Value frame - 0x09

### Description

This frame allows you to query or set device parameters. In contrast to the AT Command (0x08) frame, this frame queues new parameter values and does not apply them until you issue either:

- The **AT** Command (0x08) frame (for API type)
- The **AC** command

When querying parameter values, the 0x09 frame behaves identically to the 0x08 frame. The device returns register queries immediately and does not queue them. The response for this command is also an **AT** Command Response frame (0x88).

Send a command to change the baud rate (**BD**) to 115200 baud, but do not apply changes yet. The module continues to operate at the previous baud rate until you apply the changes.

### Format

The following table provides the contents of the frame. For details on frame structure, see [API frame format](#).

Frame data fields	Offset	Description
Frame type	3	0x09
Frame ID	4	Identifies the data frame for the host to correlate with a subsequent ACK. If set to <b>0</b> , the device does not send a response.
AT command	5-6	Command name: two ASCII characters that identify the AT command.
Parameter value ( <b>BD7</b> = 115200 baud)	7-n	If present, indicates the requested parameter value to set the given register. If no characters are present, queries the register.

**Note** In this example, the parameter could have been sent as a zero-padded 2-byte or 4-byte value.

### Example

The following example sends a command to change the baud rate (**BD**) to 115200 baud, but does not apply the changes immediately. The device continues to operate at the previous baud rate until you apply the changes.

**Note** In this example, you could send the parameter as a zero-padded 2-byte or 4-byte value.

Frame data fields	Offset	Example
Start delimiter	0	0x7E

Frame data fields	Offset	Example
Length	MSB 1	0x00
	LSB 2	0x05
Frame type	3	0x09
Frame ID	4	0x01
AT command	5	0x42 (B)
	6	0x44 (D)
Parameter value ( <b>BD7</b> = 115200 baud)	7	0x07
Checksum	8	0x68

## Transmit Request frame - 0x10

### Description

This frame causes the device to send payload data as an RF packet to a specific destination.

- For broadcast transmissions, set the 64-bit destination address to 0x000000000000FFFF . Address the coordinator by either setting the 64-bit address to all 0x00s and the 16-bit address to 0xFFFE, or setting the 64-bit address to the coordinator's 64-bit address and the 16-bit address to 0x0000.
- For all other transmissions, setting the 16-bit address to the correct 16-bit address helps improve performance when transmitting to multiple destinations. If you do not know a 16-bit address, set this field to 0xFFFE (unknown). If successful, the Transmit Status frame (0x8B) indicates the discovered 16-bit address.

You can set the broadcast radius from 0 up to **NH**. If set to 0, the value of **NH** specifies the broadcast radius (recommended). This parameter is only used for broadcast transmissions.

You can read the maximum number of payload bytes with the **NP** command.

### Format

The following table provides the contents of the frame. For details on the frame structure, see [API frame format](#).

Frame data fields	Offset	Description
Frame type	3	0x10
Frame ID	4	Identifies the data frame for the host to correlate with a subsequent ACK. If set to <b>0</b> , the device does not send a response.
64-bit destination address	5-12	MSB first, LSB last. Set to the 64-bit address of the destination device. Reserved 64-bit address for the coordinator = 0x0000000000000000 Broadcast = 0x000000000000FFFF
16-bit destination network address	MSB 13	Set to the 16-bit address of the destination device, if known. If the address is unknown or if sending a broadcast, set to 0xFFFE.
	LSB 14	
Broadcast radius	15	Sets the maximum number of hops a broadcast transmission can occur. If set to 0, the broadcast radius is set to the maximum hops value.

Frame data fields	Offset	Description
Options	16	0x01 - Disable retries 0x20 - Enable APS encryption (if EE=1) 0x40 - Use the extended transmission timeout for this destination Enabling APS encryption decreases the maximum number of RF payload bytes by 4 (below the value reported by <b>NP</b> ). Setting the extended timeout bit causes the stack to set the extended transmission timeout for the destination address. See <a href="#">Transmission, addressing, and routing</a> . All unused and unsupported bits must be set to 0.
RF data	17-n	Data sent to the destination device.

**Example**

The example shows how to send a transmission to a device if you disable escaping (**AP** = 1), with destination address 0x0013A200 40014011, and payload “TxData1B”.

Frame data fields	Offset	Example
Start delimiter	0	0x7E
Length	MSB 1	0x00
	LSB 2	0x16
Frame type	3	0x10
Frame ID	4	0x01
64-bit destination address	MSB 5	0x00
	6	0x13
	7	0xA2
	8	0x00
	9	0x40
	10	0x0A
	11	0x01
	LSB 12	0x27
16-bit destination network address	MSB 13	0xFF
	LSB 14	0xFE
Broadcast radius	15	0x00
Options	16	0x00

Frame data fields	Offset	Example
RF data	17	0x54
	18	0x78
	19	0x44
	20	0x61
	21	0x74
	22	0x61
	23	0x30
	24	0x41
Checksum	25	0x13

If you enable escaping (**AP** = 2), the frame should look like:

```
0x7E 0x00 0x16 0x10 0x01 0x00 0x7D 0x33 0xA2 0x00 0x40 0x0A 0x01 0x27 0xFF 0xFE 0x00
0x00 0x54 0x78 0x44 0x61 0x74 0x61 0x30 0x41 0x7D 0x33
```

The device calculates the checksum (on all non-escaped bytes) as [0xFF - (sum of all bytes from API frame type through data payload)].

**Example**

Send a transmission to the coordinator without specifying the coordinator's 64-bit address. The API transmit request frame should look like:

```
0x7E 0x00 0x16 0x10 0x01 0x00 0x00 0x00 0x00 0x00 0x00 0x00 0x00 0xFF
0xFE 0x00 0x00 0x54 0x78 0x32 0x43 0x6F 0x6F 0x72 0x64 0xFC
```

Where 0x16 = length (22 bytes excluding checksum)

Frame data fields	Offset	Example
Start delimiter	0	0x7E
Length	MSB 1	0x00
	LSB 2	0x16
Frame type	3	0x10
Frame ID	4	0x01

Frame data fields	Offset	Example
64-bit destination address	MSB 5	0x00
	6	0x13
	7	0xA2
	8	0x00
	9	0x40
	10	0x0A
	11	0x01
	LSB 12	0x27
16-bit destination network address	MSB 13	0xFF
	LSB 14	0xFE
Broadcast radius	15	0x00
Options	16	0x00
Data payload (Tx2Coord)	17	0x54
	18	0x78
	19	0x32
	20	0x43
	21	0x6F
	22	0x6F
	23	0x72
	24	0x64
Checksum	25	0xFC



## Explicit Addressing Command frame - 0x11

### Description

This frame is similar to Transmit Request (0x10), but it also requires you to specify the application-layer addressing fields: endpoints, cluster ID, and profile ID.

This frame causes the device to send payload data as an RF packet to a specific destination, using specific source and destination endpoints, cluster ID, and profile ID.

- For broadcast transmissions, set the 64-bit destination address to 0x000000000000FFFF . Address the coordinator by either setting the 64-bit address to all 0x00s and the 16-bit address to 0xFFFE, or setting the 64-bit address to the coordinator's 64-bit address and the 16-bit address to 0x0000.
- For all other transmissions, setting the 16-bit address to the correct 16-bit address helps improve performance when transmitting to multiple destinations. If you do not know a 16-bit address, set this field to 0xFFFE (unknown). If successful, the Transmit Status frame (0x8B) indicates the discovered 16-bit address.

You can set the broadcast radius from 0 up to **NH** to 0xFF. If set to 0, the value of **NH** specifies the broadcast radius (recommended). This parameter is only used for broadcast transmissions.

You can read the maximum number of payload bytes with the **NP** command.

---

**Note** Using source routing reduces the RF payload by two bytes per intermediate hop in the source route.

---

### Format

The following table provides the contents of the frame. For details on frame structure, see [API frame format](#).

Frame data fields	Offset	Description
Frame type	3	0x11
Frame ID	4	Identifies the data frame for the host to correlate with a subsequent ACK. If set to <b>0</b> , the device does not send a response.
64-bit destination Address	5-12	MSB first, LSB last. Set to the 64-bit address of the destination device. Reserved 64-bit address for the coordinator = 0x0000000000000000 Broadcast = 0x000000000000FFFF
16-bit destination Network Address	MSB 13  LSB 14	Set to the 16-bit address of the destination device, if known. Set to 0xFFFE if the address is unknown, or if sending a broadcast.

Frame data fields	Offset	Description
Source Endpoint	15	Source Endpoint for the transmission.
Destination Endpoint	16	Destination Endpoint for the transmission.
Cluster ID	17 18	Cluster ID used in the transmission.
Profile ID	19-20	Profile ID used in the transmission.
Broadcast Radius	21	Sets the maximum number of hops a broadcast transmission can traverse. If set to <b>0</b> , the device sets the transmission radius to the network maximum hops value.
Transmission Options	22	Bitfield of supported transmission options. Supported values include the following: 0x01 - Disable retries 0x04- Indirect Addressing 0x08- Multicast Addressing 0x20 - Enable APS encryption (if EE=1) 0x40 - Use the extended transmission timeout for this destination Enabling APS encryption decreases the maximum number of RF payload bytes by 4 (below the value reported by NP). Setting the extended timeout bit causes the stack to set the extended transmission timeout for the destination address. See <a href="#">Transmission, addressing, and routing</a> . All unused and unsupported bits must be set to 0.
Data Payload	23-n	Up to <b>NP</b> bytes per packet. Sent to the destination device.

Set all other bits to 0.

### Example

The following example sends a data transmission to a device with:

- 64-bit address: 0x00
- Source endpoint: 0xA0
- Destination endpoint: 0xA1
- Cluster ID: 0x1554
- Profile ID: 0xC105
- Payload: TxData

Frame data fields	Offset	Example
Start delimiter	0	0x7E
Length	MSB 1	0x00
	LSB 2	0x1A

Frame data fields	Offset	Example
Frame type	3	0x11
Frame ID	4	0x01
64-bit destination address	MSB 5	0x00
	6	0x00
	7	0x00
	8	0x00
	9	0x00
	10	0x00
	11	0x00
	LSB12	0x00
16-bit destination Network Address	MSB 13	0xFF
	LSB 14	0xFE
Source endpoint	15	0xA0
Destination endpoint	16	0xA1
Cluster ID	17	0x15
	18	0x54
Profile ID	19	0xC1
	20	0x05
Broadcast radius	21	0x00
Transmit options	22	0x00
Data payload	23	0x54
	24	0x78
	25	0x44
	26	0x61
	27	0x74
	28	0x61
Checksum	29	0x3A

## Remote AT Command Request frame - 0x17

### Description

Used to query or set device parameters on a remote device. For parameter changes on the remote device to take effect, you must apply changes, either by setting the Apply Changes options bit, or by sending an **AC** command to the remote.

### Format

The following table provides the contents of the frame. For details on frame structure, see [API frame format](#).

Frame data fields	Offset	Description
Frame type	3	0x17
Frame ID	4	Identifies the data frame for the host to correlate with a subsequent ACK. If set to <b>0</b> , the device does not send a response.
64-bit destination address	5-12	MSB first, LSB last. Set to the 64-bit address of the destination device. Reserved 64-bit address for the coordinator = 0x0000000000000000
16-bit destination address	13-14	Set to 0xFFFE if the address is unknown, or if sending a broadcast.
Remote command options	15	Bitfield to enable various remote command options. Supported values include:  0x01 - Disable ACK  0x40 - Use the extended transmission timeout for this destination. Setting the extended timeout bit causes the stack to set the extended transmission timeout for the destination address. For more information, see <a href="#">Transmission, addressing, and routing</a> .
AT command	16-17	Command name: two ASCII characters that identify the command.
Command parameter	18-n	If present, indicates the parameter value you request for a given register. If no characters are present, it queries the register.

### Example

The following example sends a remote command to:

In this example, the 64-bit address of the remote device is 0x0013A200 40401122. The destination 16-bit address is unknown.

Frame data fields	Offset	Example
Start delimiter	0	0x7E
Length	MSB 1	0x00
	LSB 2	0x10
Frame type	3	0x17
Frame ID	4	0x01
64-bit destination address	MSB 5	0x00
	6	0x13
	7	0xA2
	8	0x00
	9	0x40
	10	0x40
	11	0x11
	LSB 12	0x22
Reserved	13	0xFF
	14	0xFE
Remote command options	15	0x02 (apply changes)
AT command	16	0x42 (B)
	17	0x48 (H)
Command parameter	18	0x01
Checksum	19	0xF5

## Create Source Route - 0x21

### Description

This frame creates a source route in the device. A source route specifies the complete route a packet traverses to get from source to destination. For best results, use source routing with many-to-one routing.

---

**Note** Both the 64-bit and 16-bit destination addresses are required when creating a source route. These are obtained when the device receives a Route Record Indicator (0xA1) frame.

---

### Format

The following table provides the contents of the frame.

Frame data fields	Offset	Description
Frame type	3	
Frame ID	4	Always set the Frame ID to 0.
64-bit destination address	5-12	MSB first, LSB last. Set to the 64-bit address of the destination device. Reserved 64-bit address for the coordinator = 0x0000000000000000 Broadcast = 0x000000000000FFFF.
16-bit destination network address	13-14	Set to 0xFFFE if the address is unknown, or if sending a broadcast.
Route command options	15	Set to 0.
Number of addresses	16	The number of addresses in the source route (excluding source and destination). If this number is 0 or greater than the source route table size (40), the device silently discards this API frame. However, the device discards a frame with more than 11 intermediate hops.
Address 1	17	Neighbor of destination
	18	
Address 2 (closer hop)	19	Address of intermediate hop
	20	

Frame data fields	Offset	Description
Address 3	21	Neighbor of source
	22	

**Example**

You must order intermediate hop addresses starting with the neighbor of the destination and working closer to the source.

Suppose a route is found between A and E as shown in the following example.

A ' B ' C ' D ' E

If device E has the 64-bit and 16-bit addresses of 0x0013A200 40401122 and 0x3344, and if devices B, C, and D have the following 16-bit addresses:

B = 0xAABB C = 0xCCDD D = 0xEEFF

This example shows how to send the Create Source Route frame to establish a source route between A and E.

Frame data fields	Offset	Example
Start delimiter	0	0x7E
Length	MSB 1	0x00
	LSB 2	0x14
Frame type	3	0x21
Frame ID	4	0x00
64-bit destination address	MSB 5	0x00
	6	0x13
	7	0xA2
	8	0x00
	9	0x40
	10	0x40
	11	0x11
	LSB 12	0x22
16-bit destination network address	MSB 13	0x33
	LSB 14	0x44
Remote command options	15	0x00
Number of addresses	16	0x03

Frame data fields	Offset	Example
Address 1	17	0xEE
	18	0xFF
Address 2 (closer hop)	19	0xCC
	20	0xDD
Address 3	21	0xAA
	22	0xBB
Checksum	23	0x01



## AT Command Response frame - 0x88

### Description

A device sends this frame in response to an AT Command (0x08 or 0x09) frame. Some commands send back multiple frames; for example, the **ND** command.

### Format

The following table provides the contents of the frame. For details on frame structure, see [API frame format](#).

Frame data fields	Offset	Description
Frame type	3	0x88
Frame ID	4	Identifies the serial port data frame being reported. If Frame ID = 0 in <b>ATCommand Mode</b> , the device does not give an <b>ATCommand Response</b> .
AT command	5-6	Command name: two ASCII characters that identify the command.
Command status	7	0 = OK 1 = ERROR 2 = Invalid command 3 = Invalid parameter 4 = Tx failure
Command data		The register data in binary format. If the host sets the register, the device does not return this field.

### Example

If you change the **BD** parameter on a local device with a frame ID of 0x01, and the parameter is valid, the user receives the following response.

Frame data fields	Offset	Example
Start delimiter	0	0x7E
Length	MSB 1	0x00
	LSB 2	0x05
Frame type	3	0x88
Frame ID	4	0x01
AT command	5	0x42 (B)
	6	0x44 (D)
Command status	7	0x00

Frame data fields	Offset	Example
Command data		
Checksum	8	0xF0

## Modem Status frame - 0x8A

### Description

Devices send the status messages in this frame in response to specific conditions.

### Format

The following table provides the contents of the frame. For details on frame structure, see [API frame format](#).

Frame data fields	Offset	Description
Frame type	3	0x8A
Status	4	0 = Hardware reset 1 = Watchdog timer reset 2 = Joined network (routers and end devices) 3 = Disassociated 6 = Coordinator started 7 = Network security key was updated 0x0D = Voltage supply limit exceeded (PRO only) 0x11 = Modem configuration changed while join in progress 0x80+ = Ember ZigBee stack error

### Example

When a device powers up, it returns the following API frame.

Frame data fields	Offset	Example
Start delimiter	0	0x7E
Length	MSB 1	0x00
LSB 2	LSB 2	0x02
Frame type	3	0x8A
Status	4	0x06
Checksum	5	0x6F

## Transmit Status frame - 0x8B

### Description

When a Transmit Request (0x10, 0x11) completes, the device sends a Transmit Status message out of the serial interface. This message indicates if the Transmit Request was successful or if it failed.

### Format

The following table provides the contents of the frame. For details on frame structure, see [API frame format](#).

Frame data fields	Offset	Description
Frame type	3	0x8B
Frame ID	4	Identifies the serial interface data frame being reported. If Frame ID = 0 in the associated request frame, no response frame is delivered.
16-bit destination address	5	The 16-bit Network Address where the packet was delivered (if successful). If not successful, this address is 0xFFFF (destination address unknown).
	6	
Transmit retry count	7	The number of application transmission retries that occur.
Delivery status	8	0x00 = Success 0x01 = MAC ACK Failure 0x02 = CCA Failure 0x15 = Invalid destination endpoint 0x21 = Network ACK Failure 0x22 = Not Joined to Network 0x23 = Self-addressed 0x24 = Address Not Found 0x25 = Route Not Found 0x26 = Broadcast source failed to hear a neighbor relay the message 0x2B = Invalid binding table index 0x2C = Resource error lack of free buffers, timers, etc. 0x2D = Attempted broadcast with APS transmission 0x2E = Attempted unicast with APS transmission, but <b>EE</b> =0 0x32 = Resource error lack of free buffers, timers, etc. 0x74 = Data payload too large 0x75 = Indirect message unrequested
Discovery status	9	0x00 = No Discovery Overhead 0x01 = Address Discovery 0x02 = Route Discovery 0x03 = Address and Route 0x40 = Extended Timeout Discovery

### Example

In the following example, the destination device reports that a unicast data transmission was successful with a 16-bit address of 0x7D84. The transmission could have been sent with the 16-bit

address set to 0x7D84 or 0xFFFE.

Frame Fields	Offset	Example
Start delimiter	0	0x7E
Length	MSB 1	0x00
	LSB 2	0x07
Frame type	3	0x8B
Frame ID	4	0x01
16-bit destination address	5	0x7D
	6	0x84
Transmit retry count	7	0x00
Delivery status	8	0x00
Discovery status	9	0x01
Checksum	10	0x71

## Receive Packet frame - 0x90

### Description

When a device configured with a standard API Rx Indicator (**AO** = 0) receives an RF data packet, it sends it out the serial interface using this message type.

### Format

The following table provides the contents of the frame. For details on frame structure, see [API frame format](#).

Frame data fields	Offset	Description
Frame type	3	0x90
64-bit source address	4-11	The sender's 64-bit address. MSB first, LSB last.
16-bit source network address	MSB 12	The sender's 16-bit address.
	LSB 13	
Receive options	14	0x01 - Packet Acknowledged 0x02 - Packet was a broadcast packet 0x20 - Packet encrypted with APS encryption <hr/> <b>Note</b> Option values can be combined. For example, a 0x20 and a 0x01 show as a 0x21. <hr/> Other possible values: 0x00, 0x21, 0x22, 0x60, 0x61, 0x62.
Received data	15-n	The RF data that the device receives.

### Example

In the following example, a device with a 64-bit address of 0x0013A200 40522BAA sends a unicast data transmission to a remote device with payload RxData. If **AO**=0 on the receiving device, it sends the following frame out its serial interface.

Frame data fields	Offset	Example
Start delimiter	0	0x7E
Length	MSB 1	0x00
	LSB 2	0x11
Frame type	3	0x90

Frame data fields	Offset	Example
64-bit source address	MSB 4	0x00
	5	0x13
	6	0xA2
	7	0x00
	8	0x40
	9	0x52
	10	0x2B
	LSB 11	0xAA
16-bit source network address	MSB 12	0x7D
	LSB 13	0x84
Receive options	14	0x01
Received data	15	0x52
	16	0x78
	17	0x44
	18	0x61
	19	0x74
	20	0x61
Checksum	21	0x0D

## Explicit Rx Indicator frame - 0x91

### Description

When a device configured with explicit API Rx Indicator (**AO** = 1) receives an RF packet, it sends it out the serial interface using this message type.

### Format

The following table provides the contents of the frame. For details on frame structure, see [API frame format](#).

Frame data fields	Offset	Description
Frame type	3	0x91
64-bit source address	4-11	MSB first, LSB last. The sender's 64-bit address. Set to 0xFFFFFFFFFFFFFFFF (unknown 64-bit address) if the sender's 64-bit address is unknown.
16-bit source network address	12-13	The sender's 16-bit address.
Source endpoint	14	Endpoint of the source that initiates transmission.
Destination endpoint	15	Endpoint of the destination that the message is addressed to.
Cluster ID	16-17	The Cluster ID that the frame is addressed to.
Profile ID	18-19	The Profile ID that the fame is addressed to.
Receive options	20	0x01 – Packet Acknowledged 0x02 – Packet was a broadcast packet 0x20 – Packet encrypted with APS encryption
Received data	21-n	Received RF data.

### Example

In the following example, a device with a 64-bit address of 0x0013A200 40522BAA sends a broadcast data transmission to a remote device with payload RxData.

If a device sends the transmission:

- With source and destination endpoints of 0xE0
- Cluster ID = 0x2211
- Profile ID = 0xC105

If **AO** = 1 on the receiving device, it sends the following frame out its serial interface.



Frame data fields	Offset	Example
Start delimiter	0	0x7E
Length	MSB 1	0x00
	LSB 2	0x18
Frame type	3	0x91
64-bit source address	MSB 4	0x00
	5	0x13
	6	0xA2
	7	0x00
	8	0x40
	9	0x52
	10	0x2B
	LSB 11	0xAA
16-bit Source Network Address	MSB 12	0x7D
	LSB 13	0x84
Source endpoint	14	0xE0
Destination endpoint	15	0xE0
Cluster ID	16	0x22
	17	0x11
Profile ID	18	0xC1
	19	0x05
Receive options	20	0x02
Received data	21	0x52
	22	0x78
	23	0x44
	24	0x61
	25	0x74
	26	0x61
Checksum	27	0x52

## Data Sample Rx Indicator frame - 0x92

### Description

When the device receives an I/O sample frame from a remote device, it sends the sample out the serial port using this frame type (when **AO**=0). Only modules running in API mode will send I/O samples out the serial port.

### Format

The following table provides the contents of the frame. For details on frame structure, see [API frame format](#).

Frame data fields	Offset	Description
Frame type	3	0x92
64-bit source address	4-11	MSB first, LSB last. The sender's 64-bit address.
16-bit Source network address	12-13	MSB first, LSB last. The sender's 16-bit address.
Reserved	12-13	Reserved, will be 0xFFFE.
Receive options	14	Bit field: 0x01 = Packet acknowledged 0x02 = Packet is a broadcast packet Ignore all other bits
Number of samples	15	The number of sample sets included in the payload. Always set to 1.
Digital channel mask 1	16-17	Bitmask field that indicates which digital I/O lines on the remote have sampling enabled, if any.
Analog channel mask 2	18	Bitmask field that indicates which analog I/O lines on the remote have sampling enabled, if any.
Digital samples (if included)	19-20	If the sample set includes any digital I/O lines (Digital channel mask > 0), these two bytes contain samples for all enabled digital I/O lines. DIO lines that do not have sampling enabled return 0. Bits in these two bytes map the same as they do in the Digital channel mask field.

<sup>1</sup>N/A N/A N/A CD/DIC12 PWM/DIO11 RSSI/DIO10 N/A N/A

CTS/DIO7 RTS/DIO6 ASSOC/DIO5 DI04 AD3/DIO3 AD2/DIO2 AD1/DIO1 AD0/DIO0

<sup>2</sup>Supply Voltage N/A N/A N/A AD3 AD2 AD1 AD0

Frame data fields	Offset	Description
Analog sample	21-22	If the sample set includes any analog I/O lines (Analog channel mask > 0), each enabled analog input returns a 2-byte value indicating the A/D measurement of that input. Analog samples are ordered sequentially from ADO/DIO0 to AD3/DIO3.

**Example**

In the following example, the device receives an I/O sample with an analog and digital I/O from a remove device with a 64-bit serial number of 0x0013A20040522BAA and a 16-bit address of 0x7D84. If you enable pin AD1/DIO1 as an analog input, enable AD2/DIO2 and DIO4 as digital inputs (currently high), and enable AD3/DIO3 as a digital output (low) the I/O sample is shown in the API example in the following table.

Frame fields	Offset	Example
Start delimiter	0	0x7E
Length	MSB 1	0x00
	LSB 2	0x14
Frame type	3	0x92
64-bit source address	MSB 4	0x00
	5	0x13
	6	0xA2
	7	0x00
	8	0x40
	9	0x52
	10	0x2B
	LSB 11	0xAA
16-bit source network address	MSB 12	0x7D
	LSB 13	0x84
Receive options	14	0x01
Number of samples	15	0x01
Digital channel mask	16	0x00
	17	0x1C
Analog channel mask	18	0x02

Frame fields	Offset	Example
Digital samples (if included)	19	0x00
	20	0x14
Analog sample	21	0x02
	22	0x25
Checksum	23	0xF5

## XBee Sensor Read Indicator - 0x94

### Description

When the device receives a sensor sample (from a Digi 1-wire sensor adapter), it is sent out the serial port using this message type (when **AO=0**).

### Format

The following table provides the contents of the frame. For details on frame structure, see [API frame format](#).

Frame data fields	Offset	Description
Frame type	3	0x94
64-bit source address	4-11	MSB first, LSB last. The sender's 64-bit address.
16-bit Source network address	12-13	MSB first, LSB last. The sender's 16-bit address.
Receive options	14	0x01 = Packet acknowledged 0x02 = Packet is a broadcast packet
1-Wire Sensors	15	0x01 = A/D Sensor Read 0x02 = Temperature Sensor Read 0x60 = Water present (module CD pin low)
A/D Values	16	Indicates a two-byte value for each of four A/D sensors (A, B, C, D). Set to 0xFFFFFFFFFFFFFFFF if no A/Ds are found.
	17	
	18	
	19	
	20	
	21	
	22	
	23	
Temperature Read	24	Indicates the two-byte value read from a digital thermometer if present. Set to 0xFFFF if not found.
	25	

### Example

Suppose a device receives a 1-wire sensor sample from a device with a 64-bit address of 0x0013A20040522BAA and a 16-bit address of 0xDD6C. If the sensor sample comes from a 1-wire humidity sensor, the API frame could look like this (if AO=0):

For convenience, let's label the A/D and temperature readings as AD0, AD1, AD2, AD3, and T. Using the data in this example:

AD0 = 0x0002

AD1 = 0x00CE

AD2 = 0x00EA

AD3 = 0x0052

T = 0x016A

To convert these to temperature and humidity values, the following equations should be used.

Temperature (°C) = (T / 16), for T < 2048

= - (T & 0x7FF) / 16, for T >= 2048

Vsupply = (AD2 \* 5.1) / 255

Voutput = (AD3 \* 5.1) / 255

Relative Humidity = ((Voutput / Vsupply) - 0.16) / (0.0062)

True Humidity = Relative Humidity / (1.0546 - (0.00216 \* Temperature (°C))) Looking at the sample data, we have:

Vsupply = (234 \* 5.1 / 255) = 4.68

Voutput = (82 \* 5.1 / 255) = 1.64 Temperature = (362 / 16) = 22.625°C

Relative H = (161.2903 \* ((1.64/4.68) - 0.16)) = 161.2903 \* (0.19043) = 30.71%

True H = (30.71 / (1.0546 - (0.00216 \* 22.625))) = (30.71 / 1.00573) = 30.54%

Frame fields	Offset	Example
Start delimiter	0	0x7E
Length	MSB 1	0x00
	LSB 2	0x17
Frame type	3	0x94
64-bit source address	MSB 4	0x00
	5	0x13
	6	0xA2
	7	0x00
	8	0x40
	9	0x52
	10	0x2B
	LSB 11	0xAA
16-bit source network address	MSB 12	0xDD
	LSB 13	0x6C
Receive options	14	0x01
1-Wire sensors	15	0x03

Frame fields	Offset	Example
A/D Values	16	0x00
	17	0x02
	18	0x00
	19	0xCE
	20	0x00
	21	0xEA
	22	0x00
	23	0x52
Temperature Read	24	0x01
	25	0x6A
Checksum	26	0x8B

## Node Identification Indicator frame - 0x95

### Description

A device receives this frame when:

- it transmits a node identification message to identify itself
- AO=0

### Format

The following table provides the contents of the frame. For details on frame structure, see [API frame format](#).

Frame data fields	Offset	Description
Frame type	3	0x95
64-bit source address	4-11	MSB first, LSB last. The sender's 64-bit address.
16-bit source network address	12-13	MSB first, LSB last. The sender's 16-bit address.
Receive options	14	0x01 = Packet acknowledged 0x02 = Packet was a broadcast packet
Source 16-bit address	15-16	Set to the 16-bit network address of the remote device. Set to 0xFFFE if unknown.
64-bit network address	17-24	Indicates the 64-bit address of the remote device that transmitted the Node Identification Indicator frame.
NI string	25-26	Node identifier string on the remote device. The NI string is terminated with a NULL byte (0x00).
Device type	29	0=Coordinator 1=Router 2=End Device
Source event	30	1 = Frame sent by node identification pushbutton event (see <a href="#">D0 (AD0/DIO0 Configuration)</a> ) 2 = Frame sent after joining event occurred (see <a href="#">JN (Join Notification)</a> ). 3 = Frame sent after power cycle event occurred (see <a href="#">JN (Join Notification)</a> ).
Digi Profile ID	31-32	Set to Digi's application profile ID.
Digi Manufacturer ID	33-34	Set to Digi's Manufacturer ID.



**Example**

If you press the commissioning pushbutton on a remote device with 64-bit address 0x0013A200407402AC and a default **NI** string sends a Node Identification, all devices on the network receive the following node identification indicator:

A remote device with 64-bit address 0x0013A200407402AC and a default **NI** string sends a Node Identification, all devices on the network receive the following node identification indicator:

If you press the commissioning button on a remote router device with 64-bit address 0x0013A20040522BAA, 16-bit address 0x7D84, and default **NI** string, devices on the network receive the node identification indicator.

Frame data fields	Offset	Example
Start delimiter	0	0x7E
Length	MSB 1	0x00
	LSB 2	0x20
Frame type	3	0x95
64-bit source address	MSB 4	0x00
	5	0x13
	6	0xA2
	7	0x00
	8	0x40
	9	0x52
	10	0x2B
	LSB 11	0xAA
16-bit source network address	MSB 12	0x7D
	LSB 13	0x84
Receive options	14	0x02
Source 16-bit address	15	0x7D
	16	0x84

Frame data fields	Offset	Example
64-bit network address	17	0x00
	18	0x13
	19	0xA2
	20	0x00
	21	0x40
	22	0x52
	23	0x2B
	24	0xAA
NI string	25	0x20
	26	0x00
Parent 16-bit address	27	0xFF
	28	0xFE
Device type	29	0x01
Source event	30	0x01
Digi Profile ID	31	0xC1
	32	0x05
Digi Manufacturer ID	33	0x10
	34	0x1E
Checksum	35	0x1B

## Remote Command Response frame - 0x97

### Description

If a device receives this frame in response to a Remote Command Request (0x17) frame, the device sends an AT Command Response (0x97) frame out the serial interface.

Some commands, such as the **ND** command, may send back multiple frames.

### Format

The following table provides the contents of the frame. For details on frame structure, see [API frame format](#).

Frame data fields	Offset	Description
Frame type	3	0x97
Frame ID	4	This is the same value that is passed in to the request.
64-bit source (remote) address	5-12	The address of the remote device returning this response.
16-bit source (remote) address	13-14	Set to the 16-bit network address of the remote device returning this response. Set to 0xFFFE if unknown.
AT commands	15-16	The name of the command.
Command status	17	0 = OK 1 = ERROR 2 = Invalid Command 3 = Invalid Parameter 4 = Remote Command Transmission Failed
Command data	18-n	The register data in binary format. If you set the register, the device does not return this field.

### Example

If a device sends a remote command to a remote device with 64-bit address 0x0013A200 40522BAA to query the **SL** command, and if the frame ID = 0x55, the response would look like the following example.

Frame data fields	Offset	Example
Start delimiter	0	0x7E
Length	MSB 1	0x00
	LSB 2	0x13
Frame type	3	0x97
Frame ID	4	0x55

Frame data fields	Offset	Example
64-bit source (remote) address	MSB 5	0x00
	6	0x13
	7	0xA2
	8	0x00
	9	0x40
	10	0x52
	11	0x2B
	LSB 12	0xAA
16-bit source (remote) address	MSB 13	0x7D
	LSB 14	0x84
AT commands	15	0x53
	16	0x4C
Command status	17	0x00
Command data	18	0x40
	19	0x52
	20	0x2B
	21	0xAA
Checksum	22	0xF4

## Extended Modem Status frame - 0x98

### Description

If you enable the Verbose Join option (DC10), the device serially transmits trace messages to describe what is happening inside the device during association.



**WARNING!** This option is provided for diagnostic purposes. With 4x5A/7x5A or later, Verbose Join messages are disabled while the device is operating in Command mode. Prior to that revision, Verbose Join messages are interspersed with serial communications.

### Format

The following table provides the contents of the frame. For details on frame structure, see [API frame format](#).

Frame data fields	Offset	Description
Frame type	3	0x98
Status code	4	See the following table for status code descriptions.
Status data	5	The length of this field varies with the Status Code.

### Example

Frame data fields	Offset	Example
Start delimiter	0	0x7E
Length	MSB 1	0x00
	LSB 2	0x03
Checksum	6	0x5C

### Status code descriptions

The following table describes the various Verbose Join trace messages in Status Code order. The Transparent mode string column shows the string which appears if you run Verbose Join in Command Mode. The Description column gives a more detailed explanation of each particular message. When a message accompanies Status Data, the Status Data column shows how to parse the hexadecimal string into fields. The number of bytes per field appears in parentheses “()”.

Status code	Transparent mode string	Description	Status data	Description
0x00	Rejoin	A join attempt is being started.	rejoinState(1)	The rejoinState is a count of join attempts.
0x01	Stack Status	Shows status and state.	EmberStatus(1)	0x00 - no network 0x01 - joining 0x02 - joined 0x03 - joined (no parent) 0x04 - leaving
			emberNetworkState(1)	0x90 - Network is up and ready to receive/transmit. 0x91 - Network is down and cannot receive/transmit. 0x94 - Join attempt failed. 0x96 - A node's attempt to re-establish contact with the network after moving failed. 0x98 - A join attempt as a router failed due to a ZigBee 2006 versus ZigBee PRO 2007 incompatibility. Try to join as an end device. 0x99 - The network ID has changed. 0x9A - The PAN ID has changed. 0x9B - The channel has changed. 0xAB - No beacons were received in response to a beacon request.

Status code	Transparent mode string	Description	Status data	Description
0x02	Joining	An association request is being made.	radioChannel(1)	channel number ranging from 11 to 26 (0x0B to 0x1A)
			radioTxPower(1)	low level signed byte value for transmit power, values range from 0xC9 to 0x05 inclusive
			panid(2)	16 bit 4med' a network, or a Router/End Device has 'joined' a network.
			extendedPanId(8)	64 bit PAN Identifier for network
0x03	Joined	Joined - Coordinator “Formed:”, Router/End Device “Joined”		
0x04	Beacon Response	Data received from a neighboring node in response to a beacon request	ZS[stackProfile](1)	See <a href="#">ZS (ZigBee Stack Profile)</a> .
			extendedPanId(8)	64 bit PAN Identifier for network
			allowingJoin(1)	0x00 - not permitting joins to its network 0x01 - permitting joins to its network
			radioChannel(1)	channel number ranging from 11 to 26 (0x0B to 0x1A)
			panid(2)	16 bit PAN Identifier for network
			rssi(1)	maximum relative signal strength indicator value measured in units of dBm
			lqi	link quality indicator
0x05	Reject <b>ZS</b>	Not an association candidate because <b>ZS</b> does not match that given in the beacon response.		
0x06	Reject <b>ID</b>	Not an association candidate because configured pan <b>ID</b> does not match that given in the beacon response.		

Status code	Transparent mode string	Description	Status data	Description
0x07	Reject <b>NJ</b>	Not an association candidate because it is not allowing joins.		
0x08	panID Match	<b>JV/NW</b> with search option (DO80) has found a matching network	panId(2)	16 bit PAN Identifier for network
0x09	Reject LQIRSSI	<b>JV/NW</b> with search option (DO80) candidate rejected because this beacon response is weaker than an earlier beacon response.		
0x0A	Beacon Saved	This beacon response is a suitable candidate for an association request.	radioChannel(1)	channel number ranging from 11 to 26 (0x0B to 0x1A)
			radioTxPower(1)	low level signed byte value for transmit power, values range from 0xC9 to 0x05 inclusive
			panid(2)	16 bit PAN Identifier for network
			extendedPanId(8)	64 bit PAN Identifier for network
0x0B	<b>AI</b>	<b>AI</b> value has changed.	AIStatusCode(1)	See a description of <a href="#">AI (Association Indication)</a>
0x0C	Permit Join	<b>NJ</b> setting (Permit Join Duration) has changed	value(1)	See a description of the <a href="#">NJ (Node Join Time)</a> command.
0x0D	Scanning	Active scanning has begun.	ChannelMask(4)	A 32 bit value driven by the <b>SC</b> setting where bit positions 11 through 26 show which channels are enabled for the upcoming Active Scan. See a description of <a href="#">SC (Scan Channels)</a> .
0x0E	Scan Error	An error occurred during active scan.	StatusCode(1)	
0x0F	Join Request	High level request for a form/join.		
0x10	Reject LQI	Reject because LQI is worse than an already saved beacon	lqi(1)	link quality indicator



Status code	Transparent mode string	Description	Status data	Description
0x11	Reject RSSI	Rejected because RSSI is worse than an already saved beacon	rssI(1)	relative signal strength indicator
0x12	Rejected (cmdL ast)	Rejected because it matches the last associated network.		
0x13	Rejected (cmdS ave)	Rejected because it matches an already saved beacon response.		
0x14	Reject strength	During first/best phase, response is weaker than an already saved beacon response.		
0x16	Reset for DC80	With DC80 enabled, reset if no joinable beacon responses are received within 60s of joining.		
0x18	ScanCh	Scanning on Channel	radioChannel(1)	channel number ranging from 11 to 26 (0x0B to 0x1A)
0x19	Scan Mode	Shows phase of Ordered Association.	mode(1)	0: first/bestcandidate 1: ordered association by extpanid, then by channel
0x1A	Scan Init	Starting a scan	channel(1) TxPower(1)	channel being scanned low level radio transmit power setting
0x1D	Energy Scan - channel mask	Starting energy scan	<b>SC</b> mask(4)	Scan channel mask
0x1E	Energy Scan - energies	Channel Energies observed	Energies(16)	Energy Levels per channel in <b>SC</b>
0x1F	PanIdScan - radio channel	Pan Id Scan starting on channel	channel(1)	Radio Channel

Status code	Transparent mode string	Description	Status data	Description
0x20	FormNetwork - parameters	Forming a network	radioChannel(1)	channel number ranging form 11 to 26
			radioTxPower(1)	low level radio transmit power setting
			panid(2)	16 bit PAN identifier for network
			extendedpanid(8)	64 bit PAN identifier for network
0x21	Discovering <b>KE</b> Endpoint	Looking for Key Establishment Endpoint		
0x22	<b>KE</b> Endpoint	Found Key Establishment Endpoint	Endpoint(1)	Endpoint number

The following example shows a successful association with Verbose Join enabled in AT Command Mode.

**Note** Comments are included with the trace messages to explain the content and are preceded by an ellipsis "...".

```
+++OK
atid3151 OK
```

```
...configured pan identifier has been changed atdc10
OK
```

```
...and verbose join enabled atac
OK
```

```
...applying changes to the configuration V AI - Searching for Parent:FF
...search has started
V AI - Searching for Parent:FF
```

```
...and started again
V Scanning:03FFF800
```

```
...Channels 11 through 25 are enabled by the SC setting for the Active Search.
V Beacon Rsp:0000000000000042A6010B949AC8FF
```

```
...ZS(0), extendedPanId(00000000000042A6), allowingJoin(1), radiochannel(0x0B), panid(949A), rssi(C8), lqi(FF)
V Reject ID
```

...beacon response's extendedPanId does not match this radio's ID setting of 3151

```
V Beacon Rsp:0200000000000002AB010C55D2B2DB
```

...ZS(2), extendedPanId(00000000000002AB), allowingJoin(1), radiochannel(0x0C), panid(55D2), rssi(B2), lqi(DB)

```
V Reject ZS
```

...beacon response's ZS does not match this radio's ZS setting of 0x00

```
V Beacon Rsp:000000000000003151010EE29FDFFF
```

```
V Beacon Saved:0E05E29F0000000000003151
```

...this beacon response is acceptable as a candidate for association

```
V Joining:0E05E29F0000000000003151
```

...sending association request

```
V Stack Status: joined, network up 0290
```

...we are joined, the network is up, we can send and transmit

```
V Joined:
```

```
V AI - Association Succeeded:00
```

## Over-the-Air Firmware Update Status - 0xA0

### Description

The Over-the-Air Firmware Update Status frame provides an indication of the status of a firmware update transmission attempt. A query command (0x01 0x51) sent to a target with a 64-bit address of 0x0013A200 40522BAA through an updater with 64-bit address 0x0013A200403E0750 and 16-bit address 0x0000, generates the following expected response.

### Format

The following table provides the contents of the frame. For details on frame structure, see [API frame format](#).

Frame data fields	Offset	Description
Frame type	3	0xA0
64-bit Source (remote) address	4-11	MSB first, LSB last. The address of the remote radio returning this response.
16-bit destination address	12-13	The 16-bit address of the updater device.
Receive options	14	0x01 - Packet Acknowledged. 0x02 - Packet was a broadcast.
Bootloader message type	15	0x06 - ACK 0x15 - NACK 0x40 - No Mac ACK 0x51 - Query (received if the bootloader is not active on the target) 0x52 - Query Response
Block number	16	Block number used in the update request. Set to 0 if not applicable.
64-bit target address	17-n	The 64-bit Address of remote device that is being updated (target)

### Example

If a query request returns a 0x15 (NACK) status, the target is likely waiting for a firmware update image. If no messages are sent to it for about 75 seconds, the target will timeout and accept new query messages.

If a query returns a 0x51 (QUERY) status, then the target's bootloader is not active and will not respond to query messages.

Frame data fields	Offset	Example
Start delimiter	0	0x7E
Length	MSB 1	0x00

Frame data fields	Offset	Example
	LSB 2	0x16
Frame type	3	0xA0
64-bit source (remote) address	MSB 4	0x00
	5	0x13
	6	0xA2
	7	0x00
	8	0x40
	9	0x3E
	10	0x07
	11	0x50
16-bit destination address	12	0x00
	13	0x00
Receive options	14	0x01
Bootloader message type	15	0x52
Block number	16	0x00
64-bit target address	17	0x00
	18	0x13
	19	0xA2
	20	0x00
	21	0x40
	22	0x52
	23	0x2B
	24	0xAA
Checksum	25	0x66

## Route Record Indicator - 0xA1

### Description

The route record indicator is received whenever a device sends a ZigBee route record command. The device uses the route record indicator with many-to-one routing to create source routes for devices in a network.

### Format

The following table provides the contents of the frame. For details on frame structure, see [API frame format](#).

Frame data fields	Offset	Description
Frame type	3	0xA1
64-bit source (remote) address	4-11	MSB first, LSB last. The 64-bit address of the device that initiated the route record.
Source (updater) 16-bit address	12-13	The 16-bit address of the device that initiated the route record.
Receive options	14	0x01 - Packet Acknowledged. 0x02 - Packet was a broadcast.
Number of addresses	15	The number of addresses in the source route (excluding source and destination).
Address 1	16-17	(neighbor of destination)
Address 2 (closer hop)	18-19	Address of intermediate hop
Address n (neighbor of source)	20	Two bytes per 16-bit address.
	21	

### Example

Suppose device E sends a route record that traverses multiple hops en route to data collector device A as shown in the following example.

A B C D E

If device E has the 64-bit and 16-bit addresses of 0x0013A200 40401122 and 0x3344, and if devices B, C, and D have the following 16-bit addresses:

B = 0xAABB C = 0xCCDD D = 0xEEFF

The data collector sends the above API frame out its serial port.

Frame data fields	Offset	Example
Start delimiter	0	0x7E
Length	MSB 1	0x00

Frame data fields	Offset	Example
	LSB 2	0x13
Frame type	3	0xA1
64-bit source (remote) address	MSB 4	0x00
	5	0x13
	6	0xA2
	7	0x00
	8	0x40
	9	0x40
	10	0x11
	11	0x22
Source (updater) 16-bit address	12	0x33
	13	0x44
Receive options	14	0x01
Number of Addresses	15	0x03
Address 1	16	0xEE
	17	0xFF
Address 2 (closer hop)	18	0xCC
	19	0xDD
Address n (neighbor of source)	20	0xAA
	21	0xBB
Checksum	22	0x80

## Many-to-One Route Request Indicator - 0xA3

### Description

The many-to-one route request indicator frame is sent out the serial port when a many-to-one route request is received.

### Format

The following table provides the contents of the frame. For details on frame structure, see [API frame format](#).

Frame data fields	Offset	Description
Frame type	3	0xA3
64-bit source (remote) address	4-11	MSB first, LSB last. The 64-bit address of the device that sent the many-to-one route request.
Source 16-bit address	12-13	MSB first, LSB last. The 16-bit address of the device that initiated the many-to-one route request.
Reserved	14	Set to 0.

### Example

Suppose a device with a 64-bit address of 0x0013A200 40401122 and 16-bit address of 0x0000 sends a many-to-one route request. All remote routers operating in API mode that receive the many-to-one broadcast send the following example API frame out their serial port.

Frame data fields	Offset	Example
Start delimiter	0	0x7E
Length	MSB 1	0x00
	LSB 2	0x0C
Frame type	3	0xA3



Frame data fields	Offset	Example
64-bit source (remote) address	MSB 4	0x00
	5	0x13
	6	0xA2
	7	0x00
	8	0x40
	9	0x40
	10	0x11
	11	0x22
Source 16-bit address	MSB 12	0x00
	LSB 13	0x00
Reserved	14	0x00
Checksum	22	0xF4

## Send ZDO commands with the API

ZigBee specifications define ZigBee Device Objects (ZDOs) as part of the ZigBee Device Profile. These objects provide functionality to manage and map out the ZigBee network and to discover services on ZigBee devices. ZDOs are typically required when developing a ZigBee product that interoperates in a public profile such as home automation or smart energy, or when communicating with ZigBee devices from other vendors. You can also use the ZDO to perform several management functions such as frequency agility (energy detect and channel changes - Mgmt Network Update Request), discovering routes (Mgmt Routing Request) and neighbors (Mgmt LQI Request), and managing device connectivity (Mgmt Leave and Permit Join Request).

The following table shows some of the more prominent ZDOs with their respective cluster identifier. Each ZDO command has a defined payload. See the “ZigBee Device Profile” section of the ZigBee Specification for details.

ZDO command	Cluster ID
Network Address Request	0x0000
IEEE Address Request	0x0001
Node Descriptor Request	0x0002
Simple Descriptor Request	0x0004
Active Endpoints Request	0x0005
Match Descriptor Request	0x0006
Mgmt LQI Request	0x0031
Mgmt Routing Request	0x0032

ZDO command	Cluster ID
Mgmt Leave Request	0x0034
Mgmt Permit Joining Request	0x0036
Mgmt Network Update Request	0x0038

Use the Explicit Transmit API frame (0x11) to send ZigBee Device Objects commands to devices in the network. Sending ZDO commands with the Explicit Transmit API frame requires some formatting of the data payload field.

When sending a ZDO command with the API, all multiple byte values in the ZDO command (API payload), for example, u16, u32, and 64-bit addresses, must be sent in little endian byte order for the command to be executed correctly on a remote device.

For an API XBee to receive ZDO responses, set the **AO** command set to 1 to enable the explicit receive API frame.

The following table shows how you can use the Explicit API frame to send an “Active Endpoints” request to discover the active endpoints on a device with a 16-bit address of 0x1234.

Frame data fields	Offset	Description
Frame type	3	0x11
Frame ID	4	Identifies the data frame for the host to correlate with a subsequent transmit status. If set to <b>0</b> , the device does not send a response out the serial port.
64-bit destination address	5-12	MSB first, LSB last. The 64-bit address of the destination device (big endian byte order). For unicast transmissions, set to the 64-bit address of the destination device, or to 0x0000000000000000 to send a unicast to the coordinator. Set to 0x000000000000FFFF for broadcast.
16-bit destination network address	13	MSB first, LSB last. The 16-bit address of the destination device (big endian byte order). Set to 0xFFFE for broadcast, or if the 16-bit address is unknown.
	14	
Source endpoint	15	Set to 0x00 for ZDO transmissions (endpoint 0 is the ZDO endpoint).
Destination endpoint	16	Set to 0x00 for ZDO transmissions (endpoint 0 is the ZDO endpoint).
Cluster ID	17	Set to the cluster ID that corresponds to the ZDO command being sent.
	18	0x0005 = Active Endpoints Request
Profile ID	19-20	Set to 0x0000 for ZDO transmissions (Profile ID 0x0000 is the ZigBee Device Profile that supports ZDOs).
Broadcast radius	21	Sets the maximum number of hops a broadcast transmission can traverse. If set to <b>0</b> , the device sets the transmission radius to the network maximum hops value.

Frame data fields	Offset	Description
Transmission options	22	All bits must be set to 0.
Data payload	23	The required payload for a ZDO command. All multi-byte ZDO parameter values (u16, u32, 64- bit address) must be sent in little endian byte order.
	24	The Active Endpoints Request includes the following payload: [16-bit NwkAddrOfInterest]
	25	<b>Note</b> The 16-bit address in the API example (0x1234) is sent in little endian byte order (0x3412).

### Example

The following example shows how you can use the Explicit API frame to send an “Active Endpoints” request to discover the active endpoints on a device with a 16-bit address of 0x1234.

Frame data fields	Offset	Example
Start delimiter	0	0x7E
Length	MSB 1	0x00
	LSB 2	0x17
Frame type	3	0x11
Frame ID	4	0x01
64-bit destination address	MSB 5	0x00
	6	0x00
	7	0x00
	8	0x00
	9	0x00
	10	0x00
	11	0xFF
	LSB12	0xFF
16-bit Destination Network Address	MSB 13	0xFF
	LSB 14	0xFE
Source endpoint	15	0x00
Destination endpoint	16	0x00
Cluster ID	17	0x00
	18	0x05

Frame data fields	Offset	Example
Profile ID	19	0x00
	20	0x00
Broadcast radius	21	0x00
Transmit options	22	0x00
Data payload - transaction sequence number	23	0x01
Data payload - ZDO payload	24	0x34
	25	0x12
Checksum	29	0xA6

## Send ZigBee Cluster Library (ZCL) commands with the API

The ZigBee Cluster Library defines a set of attributes and commands (clusters) that can be supported in multiple ZigBee profiles. The ZCL commands are typically required when developing a ZigBee product that will interoperate in a public profile such as home automation or smart energy, or when communicating with ZigBee devices from other vendors. Applications that are not designed for a public profile or for interoperability applications can skip this section.

The following table shows some prominent clusters with their respective attributes and commands.

Cluster (Cluster ID)	Attributes (Attribute ID)	Cluster ID
Basic (0x0000)	Application Version (0x0001) Hardware Version (0x0003) Model Identifier (0x0005)	Reset to defaults (0x00)
Identify (0x0003)	Identify Time (0x0000)	Identify (0x00) Identify Query (0x01)
Time (0x000A)	Time (0x0000) Time Status (0x0001) Time Zone (0x0002)	
Thermostat (0x0201)	Local Temperature (0x0000) Occupancy (0x0002)	Setpoint raise / lower (0x00)

The ZCL defines a number of profile-wide commands that can be supported on any profile, also known as general commands. These commands include the following.

Command (Command ID)	Description
Read Attributes (0x00)	Used to read one or more attributes on a remote device.
Read Attributes Response (0x01)	Generated in response to a read attributes command.
Write Attributes (0x02)	Used to change one or more attributes on a remote device.

Command (Command ID)	Description
Write Attributes Response (0x04)	Sent in response to a write attributes command.
Configure Reporting (0x06)	Used to configure a device to automatically report on the values of one or more of its attributes.
Report Attributes (0x0A)	Used to report attributes when report conditions have been satisfied.
Discover Attributes (0x0C)	Used to discover the attribute identifiers on a remote device.
Discover Attributes Response (0x0D)	Sent in response to a discover attributes command.

Use the Explicit Transmit API frame (0x11) to send ZCL commands to devices in the network. Sending ZCL commands with the Explicit Transmit API frame requires some formatting of the data payload field.

When sending a ZCL command with the API, all multiple byte values in the ZCL command (API Payload) (for example, u16, u32, 64-bit addresses) must be sent in little endian byte order for the command to be executed correctly on a remote device.

**Note** When sending ZCL commands, set the AO command to 1 to enable the explicit receive API frame. This provides indication of the source 64- and 16-bit addresses, cluster ID, profile ID, and endpoint information for each received packet. This information is required to properly decode received data.

The following table shows how the Explicit API frame can be used to read the hardware version attribute from a device with a 64-bit address of 0x0013A200 40401234 (unknown 16-bit address). This example uses arbitrary source and destination endpoints. The hardware version attribute (attribute ID 0x0003) is part of the basic cluster (cluster ID 0x0000). The Read Attribute general command ID is 0x00.

Frame fields	Offset	Description
Frame type	3	
Frame ID	4	Identifies the serial port data frame for the host to correlate with a subsequent transmit status. If set to 0, no transmit status frame will be sent out the serial port.

Frame fields			Offset	Description
64-bit destination address			MSB 5	The 64-bit address of the destination device (big endian byte order). For unicast transmissions, set to the 64-bit address of the destination device, or to 0x0000000000000000 to send a unicast to the coordinator. Set to 0x000000000000FFFF for broadcast.
			6	
			7	
			8	
			9	
			10	
			11	
			LSB 12	
16-bit destination network address			MSB 13	The 16-bit address of the destination device (big endian byte order). Set to 0xFFFE for broadcast, or if the 16-bit address is unknown.
			LSB 14	
Source endpoint			15	Set to the source endpoint on the sending device. (0x41 arbitrarily selected).
Destination endpoint			16	Set to the destination endpoint on the remote device. (0x42 arbitrarily selected).
Cluster ID			MSB 17	Set to the cluster ID that corresponds to the ZCL command being sent. 0x0000 = Basic Cluster.
			LSB 18	
Profile ID			MSB 19	Set to the profile ID supported on the device. (0xD123 arbitrarily selected).
			LSB 20	
Broadcast radius			21	Sets the maximum number of hops a broadcast transmission can traverse. If set to 0, the transmission radius will be set to the network maximum hops value.
Transmit options			22	All bits must be set to 0.
Data payload	ZCL frame header	Frame control	23	Bitfield that defines the command type and other relevant information in the ZCL command. For more information, see the ZCL specification.

Frame fields			Offset	Description
		Transaction sequence number	24	A sequence number used to correlate a ZCL command with a ZCL response. (The hardware version response will include this byte as a sequence number in the response.) The value 0x01 was arbitrarily selected.
		Command ID	25	Since the frame control “frame type” bits are 00, this byte specifies a general command. Command ID 0x00 is a Read Attributes command.
	ZCL payload	Attribute ID	26	The payload for a “Read Attributes” command is a list of Attribute Identifiers that are being read.  <b>Note</b> The 16-bit Attribute ID (0x0003) is sent in little endian byte order (0x0300). All multi- byte ZCL header and payload values must be sent in little endian byte order.
			27	0xFF minus the 8 bit sum of bytes from offset 3 to this byte.

### Example

In this example, the Frame Control field (offset 23) is constructed as follows:

Name	Bits	Example Value Description
Frame Type	0-1	00 - Command acts across the entire profile
Manufacturer Specific	2	0 - The manufacturer code field is omitted from the ZCL Frame Header.
Direction	3	0 - The command is being sent from the client side to the server side.
Disable Default Response	4	0 - Default response not disabled.
Reserved	5-7	Set to 0.

For more information, see the ZigBee Cluster Library specification.

Frame data fields			Offset	Example
Start delimiter			0	0x7E
Length			MSB 1	0x00
			LSB 2	0x19
Frame type			3	0x11
Frame ID			4	0x01

Frame data fields			Offset	Example
64-bit destination address			MSB 5	0x00
			6	0x13
			7	0xA2
			8	0x00
			9	0x40
			10	0x40
			11	0x12
			LSB12	0x34
16-bit destination network address			MSB 13	0xFF
			LSB 14	0xFE
Source endpoint			15	0x41
Destination endpoint			16	0x42
Cluster ID			MSB 17	0x00
			LSB 18	0x00
Profile ID			MSB 19	0xD1
			LSB 20	0x23
Broadcast radius			21	0x00
Transmit options			22	0x00
Data payload	ZCL frame header	Frame control	23	0x00
		Transaction sequence number	24	0x01
		Command ID	25	0x00
	ZCL payload	Attribute ID	26	0x03
			27	0x00
Checksum			28	0xFA



## Send Public Profile Commands with the API

You can use the XBee API using the Explicit Transmit API frame (0x11) to send commands in public profiles such as Smart Energy and Home Automation. Sending public profile commands with the Explicit Transmit API frame requires some formatting of the data payload field. Most of the public profile commands fit into the ZigBee Cluster Library (ZCL) architecture as described in [Send ZigBee Cluster Library \(ZCL\) commands with the API](#).

The following table shows how you can use the Explicit API frame to send a demand response and load control message (cluster ID 0x701) in the smart energy profile (profile ID 0x0109) in the revision 14 Smart Energy specification. The device sends a “Load Control Event” message (command ID 0x00) and to a device with 64-bit address of 0x0013A200 40401234 with a 16-bit address of 0x5678. The event starts a load control event for water heaters and smart appliances for a duration of 1 minute, starting immediately.

**Note** When sending public profile commands, set the **AO** command to 1 to enable the explicit receive API frame. This provides indication of the source 64- and 16-bit addresses, cluster ID, profile ID, and endpoint information for each received packet. This information is required to properly decode received data.

### Frame specific data

Frame Fields		Offset	Description
Frame type		3	
Frame ID		4	Identifies the serial port data frame for the host to correlate with a subsequent transmit status. If set to 0, no transmit status frame will be sent out the serial port.
64-bit destination address		MSB 5	The 64-bit address of the destination device (big endian byte order). For unicast transmissions, set to the 64-bit address of the destination device, or to 0x0000000000000000 to send a unicast to the coordinator. Set to 0x000000000000FFFF for broadcast.
		6	
		7	
		8	
		9	
		10	
		11	
	LSB 12		
16-bit destination network address		MSB 13	The 16-bit address of the destination device (big endian byte order). Set to 0xFFFE for broadcast, or if the 16-bit address is unknown.
		LSB 14	
Source endpoint		15	Set to the source endpoint on the sending device. (0x41 arbitrarily selected).

Frame Fields			Offset	Description
Destination endpoint			16	Set to the destination endpoint on the remote device. (0x42 arbitrarily selected).
Cluster ID			MSB 17	Set to the cluster ID that corresponds to the ZCL command being sent. 0x0701 = Demand response and load control cluster ID
			LSB 18	
Profile ID			MSB 19	Set to the profile ID supported on the device. 0x0109 = Smart Energy profile ID.
			LSB 20	
Broadcast radius			21	Sets the maximum number of hops a broadcast transmission can traverse. If set to 0, the transmission radius will be set to the network maximum hops value.
Transmit options			22	All bits must be set to 0.
Data payload	ZCL frame header	Frame control	23	Bitfield that defines the command type and other relevant information in the ZCL command. For more information, see the ZCL specification.
		Transaction sequence number	24	A sequence number used to correlate a ZCL command with a ZCL response. (The hardware version response will include this byte as a sequence number in the response.) The value 0x01 was arbitrarily selected.
			25	Since the frame control “frame type” bits are 01, this byte specifies a cluster-specific command. Command ID 0x00 in the Demand Response and Load Control cluster is a Load Control Event command. For more information, see the Smart Energy specification.
	ZCL payload - load control event data	Issuer event ID	26	The 4-byte unique identifier. <hr/> <b>Note</b> The 4-byte ID is sent in little endian byte order (0x78563412). <hr/> The event ID in this example (0x12345678) is arbitrarily selected.
			27	
			28	
			29	

Frame Fields		Offset	Description
	Device class	30	<p>This bit encoded field represents the Device Class associated with the Load Control Event. A bit value of 0x0014 enables smart appliances and water heaters.</p> <hr/> <p><b>Note</b> The 2-byte bit field value is sent in little endian byte order.</p> <hr/>
		31	
	Utility enrollment group	32	Used to identify sub-groups of devices in the device-class. 0x00 addresses all groups.
	Start time	33	
		34	
		35	
		36	
	Duration in minutes	37	This 2-byte value must be sent in little endian byte order.
		38	
	Criticality level	39	Indicates the criticality level of the event. In this example, the level is “voluntary”.
	Cooling temperature	40	Requested offset to apply to the normal cooling set point. A value of 0xFF indicates the temperature offset value is not used.
	Heating temperature offset	41	Requested offset to apply to the normal heating set point. A value of 0xFF indicates the temperature offset value is not used.
	Cooling temperature set point	42	Requested cooling set point in 0.01 degrees Celsius. A value of 0x8000 means the set point field is not used in this event.
		43	<hr/> <p><b>Note</b> The 0x80000 is sent in little endian byte order.</p> <hr/>

Frame Fields		Offset	Description
	Heating temperature set point	44	Requested heating set point in 0.01 degrees Celsius. A value of 0x8000 means the set point field is not used in this event.
		45	<b>Note</b> The 0x80000 is sent in little endian byte order.
	Average load adjustment percentage	46	Maximum energy usage limit. A value of 0x80 indicates the field is not used.
	Duty cycle	47	Defines the maximum “On” duty cycle. A value of 0xFF indicates the duty cycle is not used in this event.
	Duty cycle event control	48	A bitmap describing event options.

### Example

In this example, the Frame Control field (offset 23) is constructed as follows:

Name	Bits	Example Value Description
Frame Type	0-1	01 - Command is specific to a cluster
Manufacturer Specific	2	0 - The manufacturer code field is omitted from the ZCL Frame Header.
Direction	3	1 - The command is being sent from the server side to the client side.
Disable Default Response	4	0 - Default response not disabled
Reserved	5-7	Set to 0.

For more information, see the ZigBee Cluster Library specification.

Frame fields	Offset	Example
Start delimiter	0	0x7E
Length	MSB 1	0x00
	LSB 2	0x19
Frame type	3	0x11
Frame ID	4	0x01

Frame fields			Offset	Example
64-bit destination address			MSB 5	0x00
			6	0x13
			7	0xA2
			8	0x00
			9	0x40
			10	0x40
			11	0x12
			LSB 12	0x34
16-bit destination network address			MSB 13	0x56
			LSB 14	0x78
Source endpoint			15	0x41
Destination endpoint			16	0x42
Cluster ID			MSB 17	0x07
			LSB 18	0x01
Profile ID			MSB 19	0x01
			LSB 20	0x09
Broadcast radius			21	0x00
Transmit options			22	0x00

Frame fields			Offset	Example
Data payload	ZCL frame header	Frame control	23	0x09
		Transaction sequence number	24	0x01
			25	0x00
	ZCL payload - load control event data	Issuer event ID	26	0x78
			27	0x56
			28	0x34
			29	0x12
		Device class	30	0x14
			31	0x00
		Utility enrollment group	32	0x00
		Start time	33	0x00
			34	0x00
			35	0x00
			36	0x00
		Duration in Minutes	37	0x01
			38	0x00
		Criticality level	39	0x04
		Cooling temperature	40	0xFF
		Heating temperature offset	41	0xFF
		Cooling temperature set point	42	0x00
			43	0x80
		Heating temperature set point	44	0x00
			45	0x80
		Average load adjustment percentage	46	0x80
		Duty cycle	47	0xFF
		Duty cycle event control	48	0x00
		Checksum		49

## AT commands

---

Network commands .....	220
Security commands .....	227
RF interfacing commands .....	228
Serial interfacing commands .....	230
I/O settings commands .....	233
Diagnostic commands .....	244
Command mode options .....	246
Sleep commands .....	247
Execution commands .....	250

The following AT commands are addressing commands.

### **DH (Destination Address High)**

Set or read the upper 32 bits of the 64-bit destination address. When you combine **DH** with **DL**, it defines the 64-bit destination address that the device uses for data transmission.

Special definitions for **DH** and **DL** include 0x000000000000FFFF (broadcast) and 0x0000000000000000 (coordinator).

#### **Parameter range**

0 - 0xFFFFFFFF

#### **Default**

0

### **DL (Destination Address Low)**

Set or read the upper 32 bits of the 64-bit destination address. When you combine **DH** with **DL**, it defines the 64-bit destination address that the device uses for data transmission.

Special definitions for **DH** and **DL** include 0x000000000000FFFF (broadcast) and 0x0000000000000000 (coordinator).

#### **Parameter range**

0 - 0xFFFFFFFF

#### **Default**

0xFFFF (Coordinator)

0 (Router/End Device)

### **MY (16-bit Network Address)**

Reads the 16-bit network address of the device. A value of 0xFFFFE means the device has not joined a ZigBee network.

#### **Parameter range**

0 - 0xFFFF [read-only]

#### **Default**

0 - 0xFFFFE

### **MP (16-bit Parent Network Address)**

#### **Parameter range**

0 - 0xFFFFE [read-only]

#### **Default**

0xFFFFE



## NC (Number of Remaining Children)

Read the number of end device children that can join the device. If **NC** returns 0, then the device cannot allow any more end device children to join.

### Parameter range

0 - MAX\_CHILDREN (maximum varies)

### Default

read-only

## SH (Serial Number High)

Reads the upper 32 bits of the device's unique IEEE 64-bit extended address. The 64-bit source address is always enabled. This value is read-only and it never changes.

### Parameter range

0 - 0xFFFFFFFF [read-only]

### Default

Set in the factory

## SL (Serial Number Low)

Reads the lower 32 bits of the device's unique IEEE 64-bit extended address. The 64-bit source address is always enabled. This value is read-only and it never changes.

### Parameter range

0 - 0xFFFFFFFF [Read-only]

### Default

Set in the factory

## NI (Node Identifier)

- XCTU prevents you from exceeding the string limit of 20 characters for this command. If you are using another software application to send the string, you can enter longer strings, but the software on the device returns an error.

Use the **ND** (Network Discovery) command with this string as an argument to easily identify devices on the network.

The **DN** command also uses this identifier.

### Parameter range

A string of case-sensitive ASCII printable characters from 0 to 20 bytes in length. The string cannot start with the space character. A carriage return or a comma automatically ends the command.

### Default

0x20 (an ASCII space character)

## SE (Source Endpoint)

Sets or displays the application layer source endpoint value. The value is used as the source endpoint for all data transmissions. **SE** is only used in Transparent mode. The default value (0xE8) is the Digi data endpoint.

### Parameter range

0 - 0xFF

### Default

0xE8

## DE (Destination Endpoint)

Sets or displays the application layer destination ID value. The value is used as the destination endpoint for all data transmissions. The default value (0xE8) is the Digi data endpoint.

### Parameter range

0 - 0xFF

### Default

0xE8

## CI (Cluster ID)

Sets or reads the application layer ID value. Use this value as the cluster ID for all data transmissions. CI is only used in transparent mode.

### Parameter range

0 - 0xFFFF

### Default

0x11 (Transparent data cluster ID)

## TO (Transmit Options)

Sets or reads the ZigBee application layer source transmit options. Use this value as the transmit options for all data transmissions in transparent mode.

### Parameter range

0 - 0xFF

### Bit field:

Unused bits must be set to 0. These bits may be logically ORed together:

Parameter	Description
0x01	Disable retries and route repair.

Parameter	Description
0x20	Enable APS Encryption (if <b>EE</b> =1).  <b>Note</b> This decreases the maximum RF payload by 4 bytes below the value reported by <b>NP</b> .
0x40	Use the extended timeout for this destination.

**Default**

0x00

**NP (Maximum Packet Payload Bytes)**

Reads the maximum number of payload bytes that you can send in a unicast RF transmission based on the device's current configuration.

Using APS encryption (API transmit option bit enabled), reduces the maximum payload size by 9 bytes. Using source routing (**AR** < 0xFF), further reduces the maximum payload size.

**Note** **NP** returns a hexadecimal value. For example, if **NP** returns 0x54, this is equivalent to 84 bytes.

**Parameter range**

0 - 0xFFFF (bytes) [read-only]

**Default**

[Read-only]

**DD (Device Type Identifier)**

The Digi device type identifier value. Use this value to differentiate between multiple devices. Digi reserves the range 0 - 0xFFFFF. For the XBee ZB SMT module, the device type is 0xA0000.

**Parameter range**

0 - 0xFFFFFFFF [Read-only]

**Default**

0xA0000

**CR (Conflict Report)**

The number of PAN ID conflict reports that must be received by the network manager within one minute to trigger a PAN ID change.

A corrupt beacon can cause a report of a false PAN ID conflict.

A higher value reduces the chance of a spurious PAN ID change.

Starting with revision 4050, setting **CR** to 0 sets the threshold value to the default configuration value (3).

**Parameter range**

1 - 0x3F

**Default**

3

## Network commands

The following commands are network commands.

### CH (Operating Channel)

Read the channel number used to transmit and receive data between RF devices and uses 802.15.4 channel numbers.

A value of 0 means the device has not joined a PAN and is not operating on any channel.

**Parameter range**

0, 0x0B - 0x1A (XBee)

0, 0x0B - 0x19 (XBee-PRO, Channels 11-25)

**Default**

[read-only]

### CE (Coordinator Enable)

Sets or reads whether the device is a coordinator.

**Parameter range**

Parameter	Description
0	Not a Coordinator
1	Coordinator ( <b>SM</b> must be 0 to set <b>CE</b> to 1.)

**Default**

### ID (Extended PAN ID)

Set or read the 64-bit extended PAN ID. If set to 0, the coordinator selects a random extended PAN ID, and the router/end device joins any extended PAN ID.

Write changes to **ID** to non-volatile memory using the **WR** command to preserve the **ID** setting if a power cycle occurs.

**Parameter range**

0 - 0xFFFFFFFFFFFFFFFF

**Default**

0

## OP (Operating Extended PAN ID)

Read the 64-bit extended PAN ID. The **OP** value reflects the operating extended PAN ID where the device is running. If ID > 0, **OP** equals **ID**.

### Parameter range

0x01 - 0xFFFFFFFFFFFFFFFF

### Default

[read-only]

## NH (Maximum Unicast Hops)

Sets or reads the maximum number of hops across the network. This limit sets the maximum broadcast hops value (**BH**) and determines the unicast timeout.

The timeout is computed as  $(50 * \mathbf{NH}) + 100$  ms. The default unicast timeout of 1.6 seconds (**NH**=0x1E) is enough time for data and the acknowledgment to traverse approximately 8 hops.

### Parameter range

0 - 0xFF

### Default

0x1E

## BH (Broadcast Hops)

The maximum transmission hops for broadcast data transmissions.

### Parameter range

0 - 0x1E

### Default

0

## OI (Operating 16-bit PAN ID)

Read the 16-bit PAN ID. The **OI** value reflects the actual 16-bit PAN ID where the device is running.

### Parameter range

0 - 0xFFFF

### Default

[read-only]

## NT (Node Discover Timeout)

Sets or reads the amount of time a base node waits for responses from other nodes when using the **ND** (Node Discover) command. When you issue the **ND** command, the transmission includes the **NT** value to provide all remote devices with a response timeout. Remote devices wait a random time, less than **NT**, before sending their response.

**Parameter range**

0x20 - 0xFF (x 100 ms)

**Default**

0x3C (60d)

**NO (Network Discovery Options)**

Set or read the network discovery options value for the **ND** (Network Discovery) command on a particular device. The options bit field value changes the behavior of the **ND** command and what optional values the local device returns when it receives an **ND** command or API Node Identification Indicator (0x95) frame.

**Parameter range**

0 - 0x03 (bit field)

**Bit field**

Option	Description
0x01	Append the <b>DD</b> (Digi Device Identifier) value to <b>ND</b> responses or API node identification frames.
0x02	Local device sends <b>ND</b> response frame when the <b>ND</b> is issued.

**Default**

0

**SC (Scan Channels)**

Set or read the list of channels to scan.

**Coordinator** - Bit field list of channels to choose from prior to starting network.

**Router/End Device** - Bit field list of channels scanned to find a Coordinator/Router to join.

Write changes to **SC** using the **WR** command to preserve the **SC** setting if a power cycle occurs.

**Parameter range**

0 - 0xFFFF (bit field)

**Bit field:**

Bit	Parameter
0	0x0B (not available on XBee-PRO)
1	0x0C
2	0x0D
3	0x0E

Bit	Parameter
4	0x0F
5	0x10
6	0x11
7	0x12
8	0x13
9	0x14
10	0x15
11	0x16
12	0x17
13	0x18 (not available on XBee-PRO)
14	0x19 (not available on XBee-PRO)
15	0x1A (not available on XBee-PRO)

---

**Note** When you are setting **SC** to 0xFFFF on the device, Channel 26 is not allowed to transmit at more than 3 dBm. If Channel 26 is present in the search mask (**SC**), active search (beaconing) for network formation by a Coordinator is limited to no more than 3 dBm on all channels. Other communication by a Coordinator/Router/EndDevice, or active search for network joining (association) by Routers and End Devices is limited to no more than 3 dBm on Channel 26. **PL** and **PM** configuration settings control the transmit power on other channels.

---

- For the XBee-PRO SMT module, Channel 26 is not allowed to transmit at more than 6 dBm.
- For the XBee-PRO TH module, Channel 26 is not allowed to transmit at more than 2 dBm.

**Default**

7FFF

**SD (Scan Duration)**

Sets or reads the scan duration exponent. Write changes to **SD** using the **WR** command.

---

**Note** If you enable channel 26 (0x8000) in the search channel mask (**SC**), the device caps transmit power on all channels at 3 dBm during network formation or joining.

---

**Coordinator** - Duration of the Active and Energy Scans (on each channel) used to determine an acceptable channel and PAN ID for the coordinator to startup on.

**Router/End Device** - Duration of Active Scan (on each channel) used to locate an available coordinator/router to join during Association.

Scan Time is measured as:

$$([\# \text{ of channels to scan}] * (2 \wedge \text{SD}) * 15.36 \text{ ms}) + (38 \text{ ms} * [\# \text{ of channels to scan}]) + 20 \text{ ms}$$

Use the **SC** (Scan Channels) command to set the number of channels to scan. The XBee can scan up to 16 channels (**SC** = 0xFFFF). The XBee-PRO can scan up to 13 channels (**SC**= 0x1FFE).

**Example**

The following table shows the results for a thirteen channel scan.

SD setting	Time
0	0.200 s
2	0.799 s
4	3.190 s
6	12.780 s

---

**Note** **SD** influences the time the MAC listens for beacons or runs an energy scan on a given channel. The **SD** time is not a accurate estimate of the router/end device joining time requirements. ZigBee joining adds additional overhead including beacon processing on each channel, and sending a join request that extend the actual joining time.

---



**Parameter range**

0 - 7 (exponent)

**Default**

3

Start an Energy Detect scan. This command accepts an argument to specify the time in milliseconds to scan IEEE 802.15.4 channels 11 through 26. The device loops through all 16 channels until the time elapses and returns the maximal energy on each channel. In Transparent mode, a comma must follow each value with the list ending with a carriage return. The values returned reflect the detected energy level in units of -dBm. Convert an **ED** response of 49, 3A, and so on, to decimal to become -73 dBm, -58 dBm, and so on.

**Parameter range**

1 - 0xFF (x1 ms)

**Default**

0x10 (16 msec)

**ZS (ZigBee Stack Profile)**

Set or read the ZigBee stack profile value. This must be the same on all devices that will join the same network. Effective with release 4x5E, changing **ZS** to a different value causes all current parameters to be written to persistent storage. While the stack profile is changing, CTS is de-asserted to prevent serial input. We recommend CTS flow control.

**Parameter range**

0 - 2

**Default**

0

**NJ (Node Join Time)**

Set or read the time that a Coordinator/Router allows nodes to join. You can change this value at run time without requiring a Coordinator or Router to restart. The time starts once the Coordinator or Router starts, and the timer resets on power-cycle or when **NJ** changes.

For an end device to enable rejoining, set **NJ** less than 0xFF on the device that joins. If **NJ** < 0xFF, the device assumes the network is not allowing joining and first tries to join a network using rejoining. If multiple rejoining attempts fail, or if **NJ**=0xFF, the device attempts to join using association.

**Parameter range**

0 - 0xFF (x1 sec)

**Default**

0xFF (always allows joining)

**JV (Channel Verification)**

Set or read the channel verification parameter.

If **JV**=1, a router or end device verifies the coordinator is on its operating channel when joining or coming up from a power cycle. If a coordinator is not detected, the router or end device leaves its current channel and attempts to join a new PAN. If **JV**=0, the router or end device continues operating on its current channel even if a coordinator is not detected.

**Parameter range**

- 0 - Channel verification disabled
- 1 - Channel verification enabled

**Default**

0

**NW (Network Watchdog Timeout)**

Set or read the network watchdog timeout value.

If **NW** is set > 0, the router monitors communication from the coordinator (or data collector) and leaves the network if it cannot communicate with the coordinator for 3 **NW** periods. The device resets the timer each time it receives or sends data to a coordinator, or if it receives a many-to-one broadcast.

**Parameter range**

- 0 - 0x64FF [x 1 minute](up to over 17 days)

**Default**

0 (disabled)

**JN (Join Notification)**

Set or read the join notification setting. If enabled, the device transmits a broadcast node identification packet on power up and when joining. This action blinks the Associate LED rapidly on all devices that receive the transmission, and sends an API frame out the serial port of API devices.

We recommend you disable this feature for large networks to prevent excessive broadcasts.

**Parameter range**

- 0 - 1

**Default**

0

**AR (Aggregate Routing Notification)**

Set or read the periodic time for broadcasting aggregate route messages. If used, these messages enable many-to-one routing to the broadcasting device. Set **AR** to 0x00 to send only one broadcast, to 0xFF to disable broadcasts, or to other values for periodic broadcasts in 10 second units.

**Parameter range**

- 0 - 0xFF (x10 sec)

**Default**

0xFF (disabled)

## Security commands

The following AT commands are security commands.

### EE (Encryption Enable)

Set or read the encryption enable setting.

#### Parameter range

0 - 1

Parameter	Description
0	Disabled
1	Enabled

#### Default

0

### EO (Encryption Options)

Configure options for encryption when **EE=1**. Set unused option bits to 0. Options include:

Options	Description
0x01	(ZigBee) Send the network key in the clear (unencrypted) over- the-air during a join
0x02	(Smart Energy) Enable as a trust center (Coordinator only)
0x08	(Smart Energy) Authenticate during joining (End Device and Router only)

#### Parameter range

0 - 0xFF

#### Default

N/A

### NK (Network Encryption Key)

Set the 128-bit AES network encryption key. This command is write-only and cannot be read. If set to 0 (default), the device selects a random network key.

#### Parameter range

128-bit value

#### Default

0

### KY (Link Key)

Sets the 128-bit AES link key value that the device uses for encryption and decryption. This command is write-only and cannot be read. If you set **KY** to 0 the coordinator transmits the network key in the clear to joining devices, and joining devices acquire the network key in the clear when joining.

**Parameter range**

128-bit value

**Default**

0

## RF interfacing commands

The following AT commands are RF interfacing commands.

### PL (TX Power Level)

Sets or reads the power level at which the device transmits conducted power.

For XBee-PRO, **PL**= 4 is calibrated and the remaining power levels are approximate. The device recalibrates its power setting every 15 seconds based on factory calibration settings, the current temperature and the amount of voltage over the typical 3.3 V. If the input voltage is too high, the device resets.

For XBee, **PL** = 4, **PM** = 1 is tested at the time of manufacturing. Other power levels are approximate. On channel 26, transmitter power will not exceed +3 dBm output.

**Parameter range**

These parameters equate to the following settings for the XBee RF module (boost mode disabled):

Setting	Power level
0	-5 dBm
1	-1 dBm
2	+1 dBm
3	+3 dBm
4	+5 dBm

These parameters equate to the following settings for the XBee-PRO RF module (boost mode enabled):

Setting	Power level
0	0 dBm (approximate)
1	+12 dBm (approximate)
2	+14 dBm (approximate)

Setting	Power level
3	+16 dBm (approximate)
4	+18 dBm

**Default**

4

**PM (Power Mode)**

Set or read the power mode of the device. Enabling boost mode improves the receive sensitivity by 2dB and increase the transmit power by 3dB.

This command is disabled on the XBee-PRO and is forced on by the software to provide extra sensitivity. Boost mode imposes a slight increase in current draw.

**Parameter range**

0 - 1

Setting	Meaning
0	Boost mode disabled
1	Boost mode enabled

**Default**

1

**DB (Received Signal Strength)**

This command reports the received signal strength of the last received RF data packet or APS acknowledgment. The **DB** command only indicates the signal strength of the last hop. It does not provide an accurate quality measurement for a multihop link. Set **DB** to 0 to clear it. The **DB** command value is measured in -dBm. For example, if **DB** returns 0x50, then the RSSI of the last packet received was -80 dBm.

**Parameter range**

0 - 0xFF

Observed ranges:

XBee-PRO - 0x1A - 0x58

XBee- 0x 1A - 0x5C

**Default**

N/A

**PP (Peak Power)**

Reads the dBm output when you select maximum power (PL4).

**Parameter range**

0x0 - 0x12

**Default**

[Read-only]

## Serial interfacing commands

The following AT commands are serial interfacing commands.

### AP (API Enable)

Enable API Mode. The device ignores this command when using SPI. API mode 1 is always used.

**Parameter range**

Parameter	Description
0	API disabled (operate in Transparent mode)
1	API enabled
2	API enabled (with escaped control characters)

**Default**

0

### AO (API Options)

Configure the options for API. The current options select the type of receive API frame to send out the UART for received RF data packets.

**Parameter range**

0 - 3

Parameter	Description
0	Default API Rx Indicator enabled
1	Default API Explicit Rx Indicator - 0x91, this is for Explicit Addressing data frames.
3	Enable ZDO passthrough of ZDO requests to the serial port that are not supported by the stack, as well as Simple_Desc_req, Active_EP_req, and Match_Desc_req.

**Default**

0

### BD (Interface Data Rate)

The device interprets any value above 0x0A as an actual baud rate. Standard baud rates up to 115200 are supported. Non-standard baud rates above 115200 are permitted but their performance is not guaranteed.

**Parameter range**

Value	Description
0x1	2,400 b/s
0x2	4,800 b/s
0x3	9,600 b/s
0x4	19,200 b/s
0x5	38,400 b/s
0x6	57,600 b/s
0x7	115,200 b/s
0x8	230,400 b/s
0x9	460,800 b/s
0xA	921,600 b/s

0 - 0x0A

Parameter	Description
8	230400 b/s
9	460800 b/s
A	921600 b/s

**Default**

3 (9600 b/s)

**NB (Parity)**

Set or display the parity settings for UART communications.

**Parameter range**

Parameter	Description
0x00	No parity
0x01	Even parity
0x02	Odd parity
0x03	Mark parity

**Default**

0x00

## SB (Stop Bits)

Sets or reads the number of stop bits for UART communications.

### Parameter range

0x00 - 0x01

Parameter	Configuration
0x00	One stop bit
0x01	Two stop bits

### Default

0x00

## RO (Packetization Timeout)

Set or read the number of character times of inter-character silence required before transmission begins when operating in Transparent mode.

Set **RO** to 0 to transmit characters as they arrive instead of buffering them into one RF packet. The **RO** command is only supported when operating in Transparent mode.

### Parameter range

0 - 0xFF (x character times)

### Default

3

Select or read options for the DIO7 line (pin 12) of the RF module.

## Parameter range

0, 1, 3 - 7

Parameter	Description
0	Unmonitored digital input
1	$\overline{\text{CTS}}$ flow control
3	Digital input
4	Digital output, low
5	Digital output, high
6	RS-485 Tx enable, low Tx
7	RS-485 Tx enable high, high Tx

## Default

1



## D6 (DIO6/RTS)

Configure the options for the DIO6 line of the device.

### Parameter range

0, 1, 3 - 5

Parameter	Description
0	Unmonitored digital input
1	$\overline{\text{RTS}}$ flow control
3	Digital input
4	Digital output, low
5	Digital output, high

### Default

0

## I/O settings commands

The following AT commands are I/O settings commands.

### IR (I/O Sample Rate)

Set or read the I/O sample rate to enable periodic sampling.

To enable periodic sampling, set **IR** to a non-zero value, and enable the analog or digital I/O functionality of at least one device pin. The sample rate is measured in milliseconds.

For more information, see the following commands:

- [D0 \(AD0/DIO0 Configuration\)](#) through [D9 \(DIO9/ON\\_SLEEP\)](#),
- [P0 \(RSSI/PWM0 Configuration\)](#) through [P4 \(DIO14/DIN\)](#).

### Parameter range

0, 0x32:0xFFFF (ms)

### Default

0

### IC (Digital Change Detection)

Set or read the digital I/O pins to monitor for changes in the I/O state.

**IC** works with the individual pin configuration commands (**D0 - D9, P0 - P4**). If you enable a pin as a digital I/O, you can use the **IC** command to force an immediate I/O sample transmission when the DIO state changes. **IC** is a bitmask that you can use to enable or disable edge detection on individual channels.

Set unused bits to 0.

Bit	I/O line
0	DIO0
1	DIO1
2	DIO2
3	DIO3
4	DIO4
5	DIO5
6	DIO6
7	DIO7
8	DIO8
9	DIO9
10	DIO10
11	DIO11

**Parameter range**

0 - 0xFFFF

0 - 0xFFFF (bit field)

**Default**

0

**P0 (RSSI/PWM0 Configuration)**

Select or read the function for PWM0.

**Parameter range**

0, 1, 3 - 5

Parameter	Description
0	Unmonitored digital input
1	RSSI PWM0
3	Digital input, monitored
4	Digital output, default low
5	Digital output, default high

**Default**

1

## P1 (DIO11/PWM1 Configuration)

Set the configure options for the DIO11 line of the RF module.

### Parameter range

0,1, 3-5

Parameter	Description
0	Unmonitored digital input
1	Output 50% duty cycle clock at 32.787 kHz
3	3- Digital input, monitored
4	Digital output, default low
5	Digital output, default high

### Default

0

## P2 (DIO12 Configuration)

Set the configuration options for the DIO12 line of the RF device.

### Parameter range

Parameter	Description
0	Unmonitored digital input
1	SPI_MISO
3	3- Digital input, monitored
4	4- Digital output, default low
5	Digital output, default high

### Default

0

## P3 (DIO13/DOUT Configuration)

Set or read the configuration options for the DIO13 line of the RF module.

### Parameter range

0, 1, 3 - 5

Parameter	Description
0	Unmonitored digital input
1	Data out for UART
3	Monitored digital input
4	Digital output low
5	Digital output high

**Default**

1

**P4 (DIO14/DIN)**

Set or read the function for DIO14.

**Parameter range**

0, 1, 3-5

Parameter	Description
0	Unmonitored digital input
1	Data in for UART
3	Digital input
4	Digital output low
5	Digital output high

**Default**

1

**P5 (DIO15/SPI\_MISO)**

The DIO15/SPI\_MISO pin configuration (pin 17). This only applies to surface-mount devices.

**Parameter range**

0, 1

Parameter	Description
0	Unmonitored digital input
1	Output from SPI port

**Default**

1

**P6 (DIO16/SPI\_MOSI)**

The DIO16/SPI\_MOSI pin configuration (pin 16). This only applies to surface-mount devices.

**Parameter range**

0, 1

Parameter	Description
0	Unmonitored digital input
1	Input to SPI port

**Default**

1

**P7 (DIO17/SPI\_SSEL )**

The DIO17/SPI\_SSEL pin configuration (pin 15). This only applies to surface-mount devices.

**Parameter range**

0, 1

Parameter	Description
0	Unmonitored digital input
1	Input to select the SPI port

**Default**

1

**P8 (DIO18/SPI\_SCLK)**

The DIO18/SPI\_SCLK pin configuration (pin 14). This only applies to surface-mount devices.

**Parameter range**

0, 1

**Default**

1

**P9 (DIO19/SPI\_ATTEN/PTI\_DATA)**

Sets or read the function for DIO19. This only applies to surface-mount devices.

**Parameter range**

0, 1, 6

**Default**

1

## D0 (AD0/DIO0 Configuration)

Sets or reads the function of AD0/DIO0.

### Parameter range

0 - 5

Parameter	Description
0	Unmonitored digital input
1	Commissioning Pushbutton
2	Analog input, single ended
3	Digital input
4	Digital output, low
5	Digital output, high

### Default

1

## D1 (AD1/DIO1/PTI\_En Configuration)

Set or read the function for the AD1/DIO1/PTI\_En configuration.

### Parameter range

0, 1, 3 - 6

0-6

Parameter	Description
0	Unmonitored digital input
1	SPI_ATTN - Analog input, single ended for the through-hole device
3	Digital input
4	Digital output, low
5	Digital output, high
6	Packet trace interface enable. Must be set along with <b>P9</b> = 6 to output traces for OTA sniffing.

### Default

0

## D2 (AD2/DIO2 Configuration)

Select or read the function for AD2/DIO2 (pin 18).

**Parameter range**

0 - 5

0 - 1

Parameter	Description
0	Unmonitored digital input
1	SPI_CLK for through-hole devices
2	Analog input, single ended
3	Digital input
4	Digital output, low
5	Digital output, high

**Default**

0

**D3 (AD3/DIO3 Configuration)**

Select or read the function for AD3/ DIO3.

**Parameter range**

0 - 5

Parameter	Description
0	Unmonitored digital input
1	SPI_SSEL for the through-hole device
2	Analog input, single ended
3	Digital input
4	Digital output, low
5	Digital output, high

**Default**

0

**D4 (DIO4 Configuration)**

Select or read the function for DIO4.

**Parameter range**

0, 1, 3 - 5

Parameter	Description
0	Unmonitored digital input
1	SPI_MOSI for the through-hole device
3	Digital input
4	Digital output, low
5	Digital output, high

**Default**

0

**D5 (DIO5/Associate Configuration)**

Configure options for the DIO5 line of the RF module.

**Parameter range**

0, 1, 3-5

Parameter	Description
0	Unmonitored digital input
1	Associate LED indicator
3	Digital input
4	Digital output, default low
5	Digital output, default high

**Default**

1

**D8 (DIO8/ $\overline{\text{DTR}}$ /SLP\_RQ)**

Set or read the function for DIO8.

**Parameter range**

0, 1, 3-5

Parameter	Description
0	Unmonitored digital input
1	Input to sleep and wake module
3	Digital input
4	Digital output, low
5	Digital output, high



**Default**

N/A

**D9 (DIO9/ON\_SLEEP)**

**Parameter range**

0, 1, 3 - 5

Parameter	Description
0	Disabled
1	ON/SLEEP output
2	N/A
3	Digital input
4	Digital output, low
5	Digital output, high

**Default**

1

**LT (Associate LED Blink Time)**

Set or read the Associate LED blink time. If you use the **D5** command to enable the Associate LED functionality (DIO5/Associate pin), this value determines the on and off blink times for the LED when the device has joined the network.

For all other **LT** values, the firmware measures **LT** in 10 ms increments.

**Parameter range**

0, 0x0A - 0xFF (100 - 2550 ms)

**Default**

0

**PR (Pull-up/Down Resistor Enable)**

The bit field that configures the internal pull-up/down resistor status for the I/O lines. If you set a **PR** bit to 1, it enables the pull-up/down resistor; 0 specifies no internal pull-up/down resistor. The following table defines the bit-field map for **PR** command.

Bit	I/O line	Module pin
0	DIO4	24/SMT, 11/TH
1	AD3/DIO3	30/SMT, 17/TH

Bit	I/O line	Module pin
2	AD2/DIO2	31/SMT, 18/TH
3	AD1/DIO1	32/SMT, 19/TH
4	AD0/DIO0	33/SMT, 20/TH
5	$\overline{\text{RTS}}$ /DIO6	/SMT, 16/TH
6	DTR/SLEEP_REQUEST	10/SMT, 9/TH
7	$\overline{\text{DIN}}$ /CONFIG	4/SMT, 3/TH
8	ASSOCIATE/DIO5	28/SMT, 15/TH
9	On/ $\overline{\text{SLEEP}}$ /DIO9	26/SMT, 13/TH
10	DIO12	5/SMT, 4/TH
11	PWM0/RSSI/DIO10/	7/SMT, 6/TH
12	PWM1/DIO11	8/SMT, 7/TH
13	$\overline{\text{CTS}}$ /DIO7	25/SMT, 12/TH
14	DOOUT/DIO13	3/SMT, 2/TH

**Parameter range**

0 - 0x7FFF (bit field)

**Default**

0x1FFF

**PD (Pull Up/Down Direction)**

The resistor pull direction bit field (1 = pull-up, 0 = pull-down) for corresponding I/O lines that are set by the **PR** command.

If the bit is set, the device uses an internal pull-up resistor. If it is clear, the device uses an internal pull-down resistor. See the **PR** command for the bit order.

**Parameter range**

0 - 0x7FFF

**Default**

0x1FBF

**RP (RSSI PWM Timer)**

The PWM timer expiration in 0.1 seconds. **RP** sets the duration of pulse width modulation (PWM) signal output on the RSSI pin. The signal duty cycle updates with each received packet and shuts off when the timer expires.

When **RP** = 0xFF, the output is always on.

**Parameter range**

0 - 0xFF (x 100 ms)

**Default**

0x28 (four seconds)

**DC (Device Controls)**

Bit settings to enable or disable certain behaviors.

Bit	Description
0	Joiner Global Link Key. Indicates whether a joiner node uses a global link key or a unique link key.
1	Network Leave Request Not Allowed. Indicates if a router node discards or accepts network leave commands.
2	Reserved
3	Reserved
4	Verbose Joining Mode. See XBee ZigBee API Operation frame type 0x98, Extended Modem Status for a full description.

**Parameter range**

0-0xFFFF

**Default**

0x00

**DO (Device Options)**

Sets or displays the device options.

**Bit field:**

Bit	Description
0	Reserved
1	Reserved for Smart Energy devices.
2	0/1 = First or Best Join. First join means the device joins the network through the first acceptable Beacon response it receives. Best join means the device joins the network through the strongest Beacon response it receives after searching all search mask channels.
3	Disable NULL transport key (coordinator Only).
4	Disable Tx packet extended timeout.
5	Disable ACK for end device I/O sampling.

Bit	Description
6	Enable high ram concentrator.
7	Enable <b>NW</b> to find new network before leaving the network.

**Parameter range**

0x00 - 0xFF

**Default**

0x00

**%V (Voltage Supply Monitoring)**

Reads the voltage on the Vcc pin in mV.

**Parameter range**

-0x - 0xFFFF [read only]

**Default**

N/A

**V+ (Voltage Supply Monitoring)**

Set the voltage supply threshold with the **V+** command. If the measured supply voltage falls below or equal to this threshold, the supply voltage appends to the I/O sample set, and sets bit 7 of the Analog Channel Mask. Set **V+** to 0 by default (do not include the supply voltage). The units of this command are mV. For example, to include a measurement of the supply voltage when it exceeds 3.3 V, set **V+** to 3300 = 0xCE4.

**Parameter range**

0 - 0xFFFF

**Default**

0

The current module temperature in degrees Celsius. The accuracy is +/- 7 degrees. 1° C = 0x0001 and -1° C = 0xFFFF.

---

**Note** This command is only available on the XBee-PRO device.

---

**Parameter range****Default****Diagnostic commands**

The following commands are diagnostic commands.

### VR (Firmware Version)

Reads the firmware version on a device as a 4-digit hex number.

**Parameter range**

0 - 0xFFFF [Read-only]

**Default**

Set in the factory

### VL (Version Long)

Shows detailed version information, device type, time stamp for the build, Ember stack version, and bootloader version.

**Parameter range**

N/A

**Default**

N/A

### HV (Hardware Version)

Read the device's hardware version. Use this command to distinguish between different hardware platforms. The upper byte returns a value that is unique to each device type. The lower byte indicates the hardware revision.

The XBee returns a value of 0x22xx for this command and the XBee-PRO returns a value of 0x21xx.

**Parameter range**

0 - 0xFFFF [Read-only]

**Default**

Set in the factory

### AI (Association Indication)

Read information regarding last node join request.

Status code	Meaning
0x00	Successfully formed or joined a network. (Coordinators form a network, routers and end devices join a network.)
0x21	Scan found no PANs.
0x22	Scan found no valid PANs based on current SC and ID settings.
0x23	Valid Coordinator or Routers found, but they are not allowing joining (NJ expired).
0x24	No joinable beacons were found.

Status code	Meaning
0x25	Unexpected state, node should not be attempting to join at this time.
0x27	Node Joining attempt failed (typically due to incompatible security settings).
0x2A	Coordinator Start attempt failed.
0x2B	Checking for an existing coordinator.
0x2C	Attempt to leave the network failed.
0xAB	Attempted to join a device that did not respond.
0xAD	Secure join error - network security key not received.
0xAF	Secure join error - joining device does not have the right preconfigured link key.
0xFF	Initialization time; no association status has been determined yet.

Applications should read **AI** until it returns 0x00, indicating a successful startup (coordinator) or join (routers and end devices).

**Parameter range**

0 - 0xFF [Read-only]

**Default**

N/A

## Command mode options

The following commands are Command mode option commands.

### CT (Command Mode Timeout)

Sets or reads the Command mode timeout parameter. If a device does not receive any valid commands within this time period, it returns to Idle mode from Command mode.

**Parameter range**

2 - 0x1770 (x 100 ms)

**Default**

0x64 (10 seconds)

### CN (Exit Command mode)

Makes the device exit Command mode.

**Parameter range**

N/A

**Default**

N/A

## GT (Guard Times)

Set the required period of silence before and after the command sequence characters of the Command mode sequence (**GT + CC + GT**). The period of silence prevents inadvertently entering Command mode.

### Parameter range

1 - 0x0CE4 (x 1 ms) (max of 3.3 decimal sec)

### Default

0x3E8 (one second)

## CC (Command Character)

Sets or reads the ASCII character value the device uses between Guard Times of the AT Command Mode Sequence (**GT + CC + GT**). The AT Command Mode Sequence enters the device into AT Command Mode.

For more information about AT Command Mode sequence, see [Command mode options](#).

### Parameter range

0 - 0xFF

### Default

0x2B (+ ASCII)

## Sleep commands

The following AT commands are sleep commands.

### SM (Sleep Mode)

Sets or reads the sleep mode of the device.

When SM>0, the device operates as an end device. However, **CE** must be 0 before **SM** can be set to a value greater than 0 to change the device to an end device. Changing a device from a router to an end device (or vice versa) forces the device to leave the network and attempt to join as the new device type when changes are applied.

### Parameter range

1, 2, 4, 5

Parameter	Description
1	Sleep disabled (router)
2	Pin sleep enabled
4	Cyclic sleep enabled
5	Cyclic sleep, pin wake

### Default

0 - Router

4 - End device

## SN (Number of Cycles Between ON\_SLEEP )

Set or read the number of sleep periods value. This command controls the number of sleep periods that must elapse between assertions of the ON\_SLEEP line during the wake time if no RF data is waiting for the end device. This command allows a host application to sleep for an extended time if no RF data is present.

### Parameter range

1 - 0xFFFF

### Default

1

## SP (Sleep Period)

Sets the duration of sleep time for the end device, up to 28 seconds. Use the **SN** command to extend the sleep time past 28 seconds. On the parent, this value determines how long the parent buffers a message for the sleeping end device. Set the value to at least equal to the longest **SP** time of any child end device.

### Parameter range

0x20 - 0xAF0 x 10ms (Quarter second resolution)

### Default

0x20

## ST (Time before Sleep)

Sets or reads the wake time of the device.

The timer resets each time the device receives serial or RF data. Once the timer expires, an end device may enter low power operation. This applies to cyclic sleep end devices only.

### Parameter range

1 - 0xFFFF (x 1 ms)

### Default

0x1388 (5 seconds)

## SO (Sleep Options)

Set or read the sleep options bit field of a device. This command is a bitmask.

Set unused option bits to 0. Sleep options should not be used for most applications. See [Managing End Devices](#).

### Parameter range

0 - 0xFF



Bit	Option
0x02	Always wake for <b>ST</b> time
0x04	Sleep entire <b>SN</b> * <b>SP</b> time

**Default**

0

**WH (Wake Host Delay)**

Sets or reads the wake host timer value. You can use **WH** to give a sleeping host processor sufficient time to power up after the device asserts the ON\_SLEEP line.

If you set **WH** to a non-zero value, this timer specifies a time in milliseconds that the device allows after waking from sleep before sending data out the UART or transmitting an I/O sample. If the device receives serial characters, the **WH** timer stops immediately.

**Parameter range**

0 - 0xFFFF (x 1 ms)

**Default**

0

**PO (Polling Rate)**

Set or read the end device poll rate. Setting this to 0 (default) enables polling at 100 ms (default rate), advancing in 10 ms increments. Adaptive polling may allow the end device to poll more rapidly for a short time when receiving RF data.

**Parameter range**

0 - 0x3E8

**Default**

0

## Execution commands

Where most AT commands set or query register values, execution commands execute an action on the device. Execution commands are executed immediately and do not require changes to be applied.

### AC (Apply Changes)

Immediately applies new settings without exiting Command mode.

Applies changes to all command registers and applies queued command register values. For example, changing the serial interface rate with the **BD** command does not change the UART interface rate until changes are applied with the **AC** command. The **CN** command and 0x08 API command frame also apply changes.

**Parameter range**

N/A

**Default**

N/A

### AS (Active Scan)

Scans the neighborhood for beacon responses. The ATAS command is only valid as a local command. Response frames are structured as:

AS\_type – unsigned byte = 2 - ZB firmware uses a different format than Wi-Fi XBee, which is type 1

Channel – unsigned byte

PAN – unsigned word in big endian format

Extended PAN – eight unsigned bytes in bit endian format

Allow Join – unsigned byte – 1 indicates join is enabled, 0 that it is disabled Stack Profile – unsigned byte

LQI – unsigned byte, higher values are better

RSSI – signed byte, lower values are better

**Parameter range**

N/A

**Default**

N/A

### WR (Write)

Writes parameter values to non-volatile memory so that parameter modifications persist through subsequent resets.

---

**Note** Once you issue a **WR** command, do not send any additional characters to the device until after you receive the **OK** response.

---

**Parameter range**

N/A

**Default**

N/A

**RE (Restore Defaults)**

This command sets all parameters except **ZS** and **KY** to their default values. To change **ZS** and **KY**, you must explicitly set them. In order for the default parameters to persist through subsequent resets, send a separate **WR** command after **RE**.

**Parameter range**

N/A

**Default**

N/A

**FR (Software Reset)**

Resets the device. The device responds immediately with an **OK** and performs a reset 100 ms later.

**Parameter range**

N/A

**Default**

N/A

**NR (Network Reset)**

Resets network layer parameters on one or more modules within a PAN. Responds immediately with an **OK** then causes a network restart. The device loses all network configuration and routing information.

If **NR** = 0: Resets network layer parameters on the node issuing the command.

If **NR** = 1: Sends broadcast transmission to reset network layer parameters on all nodes in the PAN.

**Parameter range**

0 - 1

**Default**

N/A

**SI (Sleep Immediately)**

Causes a cyclic sleep device to sleep immediately rather than wait for the **ST** timer to expire.

**Note** This command only has effect in API mode (sleeps immediately whether given as a 0x08 or 0x09 API frame), and no effect in AT command mode. AT command mode is exited only by the **CN** command or by timeout.

**Parameter range**

N/A

**Default**

N/A

### CB (Commissioning Pushbutton)

There are three kinds of button presses defined:

Button press	Description
1	Start Joining. Wakes a sleeping end device for 30 seconds, regardless of the <b>ST/SN</b> setting. Also sends node identification broadcast if joined to a network. A ZigBee device blinks its ASSOC led for (AI-32) times. A <b>SE</b> router or <b>SE</b> end device which is associated but not authenticated to a network leaves its network; then attempt to join.
2	Enable Joining. Broadcast a Mgmt_Permit_Joining_req (ZDO ClusterID 0x0036) with <b>TC_Significance</b> set to 0x00. If <b>NJ</b> is 0x00 or 0xFF, PermitDuration will be set to one minute, otherwise PermitDuration will be set to <b>NJ</b> .
4	Restore configuration to default values and leave the network.

**Parameter range**

1, 2, 4

**Default**

### &X (Clear Binding and Group Tables)

Resets the binding and group tables.

**Parameter range**

N/A

**Default**

N/A

### ND (Node Discovery)

Discovers and reports all of the devices it finds on a network. The command reports the following information after a jittered time delay.

PARENT\_NETWORK ADDRESS<CR> (2 Bytes) (always 0xFFFE)

PARENT\_NETWORK ADDRESS (2 Bytes) <CR>

DEVICE\_TYPE<CR> (1 Byte: 0 = Coordinator, 1 = Router, 2 = End Device)

STATUS<CR> (1 Byte: Reserved)  
 PROFILE\_ID<CR> (2 Bytes)  
 MANUFACTURER\_ID<CR> (2 Bytes)  
 <CR>

After (**NT** \* 100) milliseconds, the command ends by returning a <CR>.

If you send ND through a local API frame, the device returns each response as a separate AT\_CMD\_Response packet. The data consists of the above listed bytes without the carriage return delimiters. The **NI** string ends in a “0x00” null character.

**ND** also accepts a **NI** (Node Identifier) as a parameter (optional). In this case, only a device that matches the supplied identifier responds after a jittered time delay. If there are no matching devices, the command returns an “ERROR”. The jittered time delay is based on the **NT** setting.

The radius of the **ND** command is set by the **BH** command.

A status code of 1=ERROR will be returned if the transmit queue is full. That means there are already four messages queued for transmission. The application is trying to send messages faster than the device can process the requests. The application may either try again later, be redesigned to send messages at a slower rate, or wait for a Tx Status response for a prior message before attempting to send another.

For more information about the options that affect the behavior of the **ND** command, see [NO \(Network Discovery Options\)](#).

#### Parameter range

20-byte printable ASCII string

#### Default

ASCII space character (0x20)

## DN (Destination Node)

Resolves an **NI** (Node identifier) string to a physical address (case sensitive).

The following events occur after **DN** discovers the destination node:

When **DN** is sent in Command mode (AT Firmware):

1. The device sets **DL** and **DH** to the address of the device with the matching **NI** string. The address selected (either 16-bit short address or 64-bit extended address) is chosen based on the destination device's **MY** command configuration.
2. The receiving device returns OK (or ERROR).
3. The device exits Command mode to allow for immediate communication. If an ERROR is received, then Command mode does not exit.

When **DN** is sent as a local AT Command API frame (API Firmware):

1. The receiving device returns the 16-bit network and 64-bit extended addresses in an API Command Response frame.
2. If there is no response from a module within (**NT**\* 100) milliseconds or you do not specify a parameter (by leaving it blank), the receiving device returns an ERROR message. In the case of an ERROR, the device does not exit command mode. Set the radius of the **DN** command using the **BH** command.

**Parameter range**

up to 20-Byte printable ASCII string

**Default**

**IS (Force Sample)**

Forces a read of all enabled digital and analog input lines.

**Parameter range**

N/A

**Default**

N/A

## Module support

---

This section provides customization information for the XBee device. In addition to providing an extremely flexible and powerful API, XBee devices are a robust development platform that have passed FCC and other countries' testing. Developers can customize default parameters, or write or load custom firmware for the Ember EM357 chip.

XCTU configuration tool .....	256
Design considerations for Digi drop-in networking .....	256
XBee Bootloader .....	256
Programming XBee modules .....	257
Writing custom firmware .....	258

## XCTU configuration tool

Digi provides a Windows XCTU configuration tool for configuring device parameters and updating firmware. XCTU has the following capabilities:

- Discover all XBee modules in the network
- Update firmware on a local device (requires USB or serial connection)
- Read or write device configuration parameters on a local or remote device
- Save and load configuration profiles containing customized settings

For instructions on downloading and using XCTU, go to:

<http://www.digi.com/products/xbee-rf-solutions/xctu-software/xctu>

### Customizing XBee ZigBee firmware

Once device parameters are tested in an application and finalized, we can manufacture devices with specific, customer-defined configurations. These custom configurations can lock in a firmware version or set command values when the devices are manufactured, eliminating the need for customers to adjust device parameters on arrival. Alternatively, we can program custom firmware, including Ember's EZSP UART image, into the devices during manufacturing. Contact Digi to create a custom configuration.

## Design considerations for Digi drop-in networking

XBee RF devices contain a variety of features that allow for interoperability with Digi's full line of Drop-in Networking products. Interoperability with other "DIN" products offers these advantages:

- Add IP-connectivity to your network via Cellular, Ethernet or Wi-Fi with a ConnectPort X Gateway.
- Extend the range of your network with the XBee Wall Router.
- Make deployment easy by enabling the Commissioning Pushbutton (pin 20) and AssociateLED (pin 15) to operate with the Network Commissioning Tool software.
- Interface with standard RS-232, USB, Analog and Digital I/O, RS-485, and other industrial devices using XBee Adapters.
- Monitor and manage your network securely from remote locations with Device Cloud.

We encourage you to contact our technical representatives for consideration, implementation, or design review of your product for interoperability with Digi's Drop-in Networking solutions.

## XBee Bootloader

XBee modules use a modified version of Ember's bootloader. This bootloader version supports a custom entry mechanism that uses module pins DIN (pin 4/SMT, pin 3/TH), DTR / SLEEP\_RQ (pin 10/SMT, pin9/TH), and RTS (pin 29/SMT, pin16/TH).

To invoke the bootloader, do the following:

1. Set  $\overline{\text{DTR/SLEEP\_RQ}}$  low (TTL 0V) and RTS high.
2. Send a serial break to the DIN pin and power cycle or reset the module.
3. When the device powers up, set  $\overline{\text{DTR/SLEEP\_RQ}}$  and DIN to low (TTL 0V) and RTS should be high.



4. Terminate the serial break and send a carriage return at 115200b/s to the device.
5. If successful, the device sends the Ember bootloader menu out the DOUT pin at 115200b/s.
6. You can send commands can be sent to the bootloader at 115200 b/s.

---

**Note** Disable hardware flow control when entering and communicating with the Ember 357 bootloader.

---

## Programming XBee modules

Firmware on the XBee module can be updated serially.

### Serial firmware updates

Serial firmware updates use the XBee custom bootloader which ships in all units. This modified bootloader is based on Ember's standalone bootloader, but with a modified entry mechanism. The modified entry mechanism uses device pins 4, 10, and 29 (DIN, DTR, and RTS respectively) on the SMT, and pins 3, 9, 16 on the TH.

The XCTU program can update firmware serially on the XBee. Contact Digi support for details.

If an application requires custom firmware to update the XBee firmware serially, complete the following steps.

### Invoke the XBee Bootloader

See [XBee Bootloader](#) for steps to invoke the bootloader using RS-232 signals. You can also invoke the bootloader by issuing a command using XCTU. The application makes an explicit call to the bootloader, which does not return.

If there is no valid application, the bootloader always runs.

### Send a firmware image

After invoking the bootloader, the Ember bootloader sends the bootloader menu characters out the serial port, which may be the UART at 115200 b/s or the SPI, where the attached SPI master provides the clock rate. To upload a firmware image:

1. Look for the bootloader prompt **BL >** to ensure the bootloader is active.
2. Send an ASCII **1** character to initiate a firmware update.
3. After sending a **1**, the EM357 waits for an XModem CRC upload of an .ebl image over the serial line at 115200 b/s. Send the .ebl file to the EM357 in order.

If the firmware image is successfully loaded, the bootloader outputs a "complete" string. Invoke the newly loaded firmware by sending a **2** to the device.

If the firmware image is not successfully loaded, the bootloader outputs an "aborted string". It return to the main bootloader menu. Some causes for failure are:

- Over 1 minute passes after the command to send the firmware image and the first block of the image has not yet been sent.
- A power cycle or reset event occurs during the firmware load.
- A file error or a flash error occurs during the firmware load.

## Writing custom firmware

You can use the XBee module as a hardware development platform for the EM357. You can develop custom firmware images around the EmberZNet 4.2.xx mesh stacks (for the EM357) and uploaded to the XBee.



**CAUTION!** If you are programming firmware through the JTAG interface, you can potentially erase the XBee bootloader. If this occurs, serial firmware updates will not work.

## Regulatory compliance

XBee modules are FCC and European certified for operation on all 16 channels. You can configure the EM357 output power up to 8 dBm with boost mode enabled on channels 11 through 25. On channel 26 you must reduce the power to 3 dBm.

XBee-PRO devices are FCC certified for operation on all 16 channels. The XBee-PRO contains a power compensation method to adjust the output power near 18 dBm on channels 11 through 25. You must configure the EM357 with an output power so the device outputs 18 dBm or less on channels 11 through 25. On channel 26, you must reduce the power to no more than 0 dBm. The end product is responsible to adhere to these requirements.

This section describes how to configure GPIOs to function correctly in custom applications that run on the XBee modules.

## Enable GPIO 1 and 2

For GPIO pins to be configurable, the application must set the GPIO\_PxCFGL registers to enable the appropriate GPIO. The following table lists values for configuring the GPIO pins. Other functionality is affected by these settings. See the EM357 datasheet from Ember for a complete listing of functionality.

GPIO mode	GPIO_PxCFGL	Description
Analog	0x0	Analog input or output. When in analog mode, the digital input (GPIO_PxIN) always reads 1.
Input (floating)	0x4	Digital input without an internal pull-up or pull-down. Output is disabled.
Input (pull-up or pull-down)	0x8	Digital input with an internal pull-up or pull-down. A set bit in GPIO_PxOUT selects pull-up and a cleared bit selects pull-down. Output is disabled.
Output (push-pull)	0x1	Push-pull output. GPIO_PxOUT controls the output.
Output (open-drain)	0x5	Open-drain output. GPIO_PxOUT controls the output. If a pull-up is required, it must be external.
Alternate Output (push-pull)	0x9	Push-pull output. An on-board peripheral controls the output.
Alternate Output (open-drain)	0xD	Open-drain output. An on-board peripheral controls the output. If a pull-up is required, it must be external.

For more information on configuring and setting GPIOs, consult the EM357 specification.

## Detect XBee versus XBee-PRO

For some applications, you may need to determine if the code is running on an XBee or an XBee-PRO device.

1. Use the PC7 pin on the EM357 to identify the device type.
2. Connect PC7 to ground on the XBee module.
3. Use the following code to determine if a device is an XBee or an XBee-PRO:

```
GPIO_PCSET = 0x80; // Enable pullup resistor
GPIO_PCCFGH &= 0x0fff; // Clear PC7 config
GPIO_PCCFGH |= 0x8000; // Set PC7 as input with pullup/pulldown
if (GPIO_PCIN & 0x80) {
    ModuleIsXBeePro = true;
} else {
    ModuleIsXBeePro = false;
}
```

## Special instructions for using the JTAG interface

There are four JTAG programming pins on the XBee through which firmware can be loaded onto the EM357 processor. Three of these pins are also connected to a second pin on the XBee and are used for separate functions. The following table indicates the JTAG signal name, the primary connection pin on the XBee, the secondary connection pin, and the secondary signal name.



**CAUTION!** Do not load the secondary pins with circuitry that might interfere with JTAG programming (for example, an LED tied directly to the ASSOCIATE / DIO5 line). Any loading circuitry should be buffered to avoid conflicts (for example, connecting ASSOCIATE / DIO5 to the gate of a MOSFET which drives the LED).

JTAG pin name	Primary XBee pin	Secondary XBee pin	Secondary pin name
JTCK	18	N/A	N/A
JTDO	19	26	ON / SLEEP / DIO9
JTDI	20	28	ASSOCIATE / DIO5
JTMS	21	5	DIO12

## Certifications

---

United States (FCC) .....	261
Europe .....	280
IC (Industry Canada) Certification .....	281
Australia (RCM) .....	283
ANATEL (Brazil) certification .....	283

## United States (FCC)

The XBee/XBee-PRO ZigBee RF Modules comply with Part 15 of the FCC rules and regulations. Compliance with the labeling requirements, FCC notices and antenna usage guidelines is required.

To fulfill FCC Certification, the OEM must comply with the following regulations:

1. The system integrator must ensure that the text on the external label provided with this device is placed on the outside of the final product.
2. RF Modules may only be used with antennas that have been tested and approved for use with the modules. See [FCC-approved antennas \(2.4 GHz\)](#).

### OEM labeling requirements

---



**WARNING!** As an Original Equipment Manufacturer (OEM) you must ensure that FCC labeling requirements are met. You must include a clearly visible label on the outside of the final product enclosure that displays the following content:

---

#### ***Required FCC Label for OEM products containing the XBee S2C SMT RF Module***

Contains FCC ID: MCQ-S2DSM

This device complies with Part 15 of the FCC Rules. Operation is subject to the following two conditions: (1.) this device may not cause harmful interference and (2.) this device must accept any interference received, including interference that may cause undesired operation.

#### ***Required FCC Label for OEM products containing the XBee S2C SMT RF Module***

Contains FCC ID: MCQ-XBS2C

This device complies with Part 15 of the FCC Rules. Operation is subject to the following two conditions: (1.) this device may not cause harmful interference and (2.) this device must accept any interference received, including interference that may cause undesired operation.

#### ***Required FCC Label for OEM products containing the XBee-PRO S2C SMT RF Module***

Contains FCC ID: MCQ-PS2CSM

This device complies with Part 15 of the FCC Rules. Operation is subject to the following two conditions: (1.) this device may not cause harmful interference and (2.) this device must accept any interference received, including interference that may cause undesired operation.

---

**Note** Legacy XBee-PRO SMT (Model: PRO S2C; hardware version 21xx) has FCC ID: MCQ-XBPS2C.

---

#### ***Required FCC Label for OEM products containing the XBee S2C TH RF Module***

Contains FCC ID: MCQ-S2CTH

This device complies with Part 15 of the FCC Rules. Operation is subject to the following two conditions: (1.) this device may not cause harmful interference and (2.) this device must accept any interference received, including interference that may cause undesired operation.

#### ***Required FCC Label for OEM products containing the XBee-PRO S2C TH RF Module***

Contains FCC ID: MCQ-PS2CTH

This device complies with Part 15 of the FCC Rules. Operation is subject to the following two conditions: (1.) this device may not cause harmful interference and (2.) this device must accept any interference received, including interference that may cause undesired operation.

## FCC notices

**IMPORTANT:** The XBee and XBee-PRO RF Modules have been certified by the FCC for use with other products without any further certification (as per FCC section 2.1091). Modifications not expressly approved by Digi could void the user's authority to operate the equipment.

**IMPORTANT:** OEMs must test final product to comply with unintentional radiators (FCC section 15.107 & 15.109) before declaring compliance of their final product to Part 15 of the FCC Rules.

**IMPORTANT:** The RF module has been certified for remote and base radio applications. If the module will be used for portable applications, the device must undergo SAR testing.

This equipment has been tested and found to comply with the limits for a Class B digital device, pursuant to Part 15 of the FCC Rules. These limits are designed to provide reasonable protection against harmful interference in a residential installation. This equipment generates, uses and can radiate radio frequency energy and, if not installed and used in accordance with the instructions, may cause harmful interference to radio communications. However, there is no guarantee that interference will not occur in a particular installation.

If this equipment does cause harmful interference to radio or television reception, which can be determined by turning the equipment off and on, the user is encouraged to try to correct the interference by one or more of the following measures: Re-orient or relocate the receiving antenna, Increase the separation between the equipment and receiver, Connect equipment and receiver to outlets on different circuits, or Consult the dealer or an experienced radio/TV technician for help.

## FCC-approved antennas (2.4 GHz)

The XBee and XBee-PRO ZB RF Modules can be installed utilizing antennas and cables constructed with non-standard connectors (RPSMA, RPTNC, etc.) An adapter cable may be necessary to attach the XBee connector to the antenna connector.

The modules are FCC approved for fixed base station and mobile applications for the channels indicated in the tables below. If the antenna is mounted at least 25 cm (10 in) from nearby persons, the application is considered a mobile application. Antennas not listed in the table must be tested to comply with FCC Section 15.203 (Unique Antenna Connectors) and Section 15.247 (Emissions).

The antennas in the tables below have been approved for use with this module. Cable loss is required when using gain antennas as shown in the tables. Digi does not carry all of these antenna variants. Contact Digi Sales for available antennas.

1. If using the RF module in a portable application (for example, if the module is used in a handheld device and the antenna is less than 25 cm from the human body when the device is in operation), The integrator is responsible for passing additional SAR (Specific Absorption Rate) testing based on FCC rules 2.1091 and FCC Guidelines for Human Exposure to Radio Frequency Electromagnetic Fields, OET Bulletin and Supplement C. The testing results will be submitted to the FCC for approval prior to selling the integrated unit. The required SAR testing measures emissions from the module and how they affect the person.
2. ZigBee firmware will be limited to 32% duty cycle on channel 26.
3. If you are using 802.15.4 firmware with up to a 66% duty cycle on this channel.

### XBee ZigBee SMT RF module

The following table shows the antennas approved for use with the XBee ZigBee SMT RF module.

Part number	Type (description)	Gain (dBi)	Application*	Min. separation	Minimum Cable Loss/ Power Reduction/ Attenuation Required	
					Channels 11-25	Channel 26
<b>Integral antennas</b>						
29000313	Integral PCB antenna	0.0	Fixed/Mobile	20 cm	N/A	N/A
A24-QI	Monopole (Integrated whip)	1.5	Fixed/Mobile	20 cm	N/A	N/A
<b>Dipole antennas</b>						
A24-HASM-450	Dipole (Half-wave articulated RPSMA - 4.5")	2.1	Fixed	20 cm	N/A	N/A
A24-HABSM	Dipole (Articulated RPSMA)	2.1	Fixed	20 cm	N/A	N/A
29000095	Dipole (Half-wave articulated RPSMA - 4.5")	2.1	Fixed/Mobile	20 cm	N/A	N/A
A24-HABUF-P5I	Dipole (Half-wave articulated bulkhead mount U.F.L. w/ 5" pigtail)	2.1	Fixed/Mobile	20 cm	N/A	N/A
A24-HASM-525	Dipole (Half-wave articulated RPSMA - 5.25")	2.1	Fixed	20 cm	N/A	N/A
<b>Omni-directional antennas</b>						
A24-F2NF	Omni-directional (Fiberglass base station)	2.1	Fixed/Mobile	20 cm	N/A	N/A
A24-F3NF	Omni-directional (Fiberglass base station)	3.0	Fixed/Mobile	20 cm	N/A	N/A
A24-F5NF	Omni-directional (Fiberglass base station)	5.0	Fixed	20 cm	N/A	N/A



Part number	Type (description)	Gain (dBi)	Application*	Min. separation	Minimum Cable Loss/ Power Reduction/ Attenuation Required	
					Channels 11-25	Channel 26
A24-F8NF	Omni-directional (Fiberglass base station)	8.0	Fixed	2 m	N/A	N/A
A24-F9NF	Omni-directional (Fiberglass base station)	9.5	Fixed	2 m	N/A	N/A
A24-F10NF	Omni-directional (Fiberglass base station)	10.0	Fixed	2 m	N/A	N/A
A24-F12NF	Omni-directional (Fiberglass base station)	12.0	Fixed	2 m	N/A	2.0
A24-W7NF	Omni-directional (Fiberglass base station)	7.2	Fixed	2 m	N/A	N/A
A24-M7NF	Omni-directional (Mag-mount base station)	7.2	Fixed	2 m	N/A	N/A
A24-F15NF	Omni-directional (Fiberglass base station)	15.0	Fixed	2 m	N/A	5.0
<b>Panel antennas</b>						
A24-P8SF	Flat Panel	8.5	Fixed	2 m	N/A	3.0
A24-P8NF	Flat Panel	8.5	Fixed	2 m	N/A	3.0
A24-P13NF	Flat Panel	13.0	Fixed	2 m	N/A	7.5
A24-P14NF	Flat Panel	14.0	Fixed	2 m	N/A	8.5
A24-P15NF	Flat Panel	15.0	Fixed	2 m	N/A	9.5
A24-P16NF	Flat Panel	16.0	Fixed	2 m	N/A	10.5

Part number	Type (description)	Gain (dBi)	Application*	Min. separation	Minimum Cable Loss/ Power Reduction/ Attenuation Required	
					Channels 11-25	Channel 26
A24-P19NF	Flat Panel	19.0	Fixed	2 m	N/A	13.5
<b>Yagi antennas</b>						
A24-Y6NF	Yagi (6-element)	8.8	Fixed	2 m	N/A	2.8
A24-Y7NF	Yagi (7-element)	9.0	Fixed	2 m	N/A	3.0
A24-Y9NF	Yagi (9-element)	10.0	Fixed	2 m	N/A	4.0
A24-Y10NF	Yagi (10-element)	11.0	Fixed	2 m	N/A	5.0
A24-Y12NF	Yagi (12-element)	12.0	Fixed	2 m	N/A	6.0
A24-Y13NF	Yagi (13-element)	12.0	Fixed	2 m	N/A	6.0
A24-Y15NF	Yagi (15-element)	12.5	Fixed	2 m	N/A	6.5
A24-Y16NF	Yagi (16-element)	13.5	Fixed	2 m	N/A	7.5
A24-Y16RM	Yagi (16-element, RPSMA connector)	13.5	Fixed	2 m	N/A	7.5
A24-Y18NF	Yagi (18-element)	15.0	Fixed	2 m	N/A	9.0

### XBee ZigBee TH RF module

The following table shows the antennas approved for use with the XBee ZigBee TH RF Module.

Part number	Type (description)	Gain (dBi)	Application*	Min. separation	Required antenna cable loss (dB)	
					Channels 11-25	Channel 26
<b>Integral antennas</b>						
29000294	Integral PCB antenna	-0.5	Fixed/Mobile	20 cm	N/A	N/A
A24-QI	Monopole (Integrated whip)	1.5	Fixed/Mobile	20 cm	N/A	N/A
<b>Dipole antennas</b>						
A24-HASM-450	Dipole (Half-wave articulated RPSMA - 4.5")	2.1	Fixed	20 cm	N/A	N/A
A24-HABSM	Dipole (Articulated RPSMA)	2.1	Fixed	20 cm	N/A	N/A
29000095	Dipole (Half-wave articulated RPSMA - 4.5")	2.1	Fixed/Mobile	20 cm	N/A	N/A
A24-HABUF-P5I	Dipole (Half-wave articulated bulkhead mount U.F.L. w/ 5" pigtail)	2.1	Fixed/Mobile	20 cm	N/A	N/A
A24-HASM-525	Dipole (Half-wave articulated RPSMA - 5.25")	2.1	Fixed	20 cm	N/A	N/A
<b>Omni-directional antennas</b>						
A24-F2NF	Omni-directional (Fiberglass base station)	2.1	Fixed/Mobile	20 cm	N/A	N/A
A24-F3NF	Omni-directional (Fiberglass base station)	3.0	Fixed/Mobile	20 cm	N/A	N/A
A24-F5NF	Omni-directional (Fiberglass base station)	5.0	Fixed	20 cm	N/A	N/A
A24-F8NF	Omni-directional (Fiberglass base station)	8.0	Fixed	2 m	N/A	2.0

Part number	Type (description)	Gain (dBi)	Application*	Min. separation	Required antenna cable loss (dB)	
					Channels 11-25	Channel 26
A24-F9NF	Omni-directional (Fiberglass base station)	9.5	Fixed	2 m	N/A	3.5
A24-F10NF	Omni-directional (Fiberglass base station)	10.0	Fixed	2 m	N/A	4.0
A24-F12NF	Omni-directional (Fiberglass base station)	12.0	Fixed	2 m	N/A	6.0
A24-W7NF	Omni-directional (Fiberglass base station)	7.2	Fixed	2 m	N/A	1.2
A24-M7NF	Omni-directional (Mag-mount base station)	7.2	Fixed	2 m	N/A	1.2
A24-F15NF	Omni-directional (Fiberglass base station)	15.0	Fixed	2 m	N/A	9.0
<b>Panel antennas</b>						
A24-P8SF	Flat Panel	8.5	Fixed	2 m	N/A	2.5
A24-P8NF	Flat Panel	8.5	Fixed	2 m	N/A	2.5
A24-P13NF	Flat Panel	13.0	Fixed	2 m	N/A	7.0
A24-P14NF	Flat Panel	14.0	Fixed	2 m	N/A	8.0
A24-P15NF	Flat Panel	15.0	Fixed	2 m	N/A	9.0
A24-P16NF	Flat Panel	16.0	Fixed	2 m	N/A	10.0
A24-P19NF	Flat Panel	19.0	Fixed	2 m	N/A	13.0
<b>Yagi antennas</b>						
A24-Y6NF	Yagi (6-element)	8.8	Fixed	2 m	N/A	2.8
A24-Y7NF	Yagi (7-element)	9.0	Fixed	2 m	N/A	3
A24-Y9NF	Yagi (9-element)	10.0	Fixed	2 m	N/A	4
A24-Y10NF	Yagi (10-element)	11.0	Fixed	2 m	N/A	5

Part number	Type (description)	Gain (dBi)	Application*	Min. separation	Required antenna cable loss (dB)	
					Channels 11-25	Channel 26
A24-Y12NF	Yagi (12-element)	12.0	Fixed	2 m	N/A	6.5
A24-Y13NF	Yagi (13-element)	12.0	Fixed	2 m	N/A	6.5
A24-Y15NF	Yagi (15-element)	12.5	Fixed	2 m	N/A	6.5
A24-Y16NF	Yagi (16-element)	13.5	Fixed	2 m	N/A	7.5
A24-Y16RM	Yagi (16-element, RPSMA connector)	13.5	Fixed	2 m	N/A	7.5
A24-Y18NF	Yagi (18-element)	15.0	Fixed	2 m	0.4	9.0

### XBee-PRO ZigBee SMT RF module

The following table shows the antennas approved for use with the XBee-PRO ZigBee SMT RF Module.

Part Number	Type (Description)	Gain (dBi)	Application*	Min Separation	Required antenna cable loss (dB)	
					Channels 11-25	Channel 26
<b>Internal antennas</b>						
29000313	Integral PCB antenna	0.0	Fixed/Mobile	20 cm	N/A	N/A
A24-QI	Monopole (Integrated whip)	1.5	Fixed/Mobile	20 cm	N/A	N/A
<b>Dipole antennas</b>						
A24-HASM-450	Dipole (Half-wave articulated RPSMA - 4.5")	2.1	Fixed	20 cm	N/A	N/A
A24-HABSM	Dipole (Articulated RPSMA)	2.1	Fixed	20 cm	N/A	N/A
29000095	Dipole (Half-wave articulated RPSMA - 4.5")	2.1	Fixed/Mobile	20 cm	N/A	N/A
A24-HABUF-P5I	Dipole (Half-wave articulated bulkhead mount U.FL w/ 5" pigtail)	2.1	Fixed/Mobile	20 cm	N/A	N/A
A24-HASM-525	Dipole (Half-wave articulated RPSMA - 5.25")	2.1	Fixed	20 cm	N/A	N/A
<b>Omni-directional antennas</b>						
A24-F2NF	Omni-directional (Fiberglass base station)	2.1	Fixed/Mobile	20 cm	N/A	N/A
A24-F3NF	Omni-directional (Fiberglass base station)	3.0	Fixed/Mobile	20 cm	N/A	N/A
A24-F5NF	Omni-directional (Fiberglass base station)	5.0	Fixed	20 cm	N/A	N/A
A24-F8NF	Omni-directional (Fiberglass base station)	8.0	Fixed	2 m	N/A	1.3

Part Number	Type (Description)	Gain (dBi)	Application*	Min Separation	Required antenna cable loss (dB)	
					Channels 11-25	Channel 26
A24-F9NF	Omni-directional (Fiberglass base station)	9.5	Fixed	2 m	N/A	2.8
A24-F10NF	Omni-directional (Fiberglass base station)	10	Fixed	2 m	N/A	3.3
A24-F12NF	Omni-directional (Fiberglass base station)	12	Fixed	2 m	N/A	5.3
A24-W7NF	Omni-directional (Fiberglass base station)	7.2	Fixed	2 m	N/A	.5
A24-M7NF	Omni-directional (Mag-mount base station)	7.2	Fixed	2 m	N/A	.5
A24-F15NF	Omni-directional (Fiberglass base station)	15.0	Fixed	2 m	1.1	8.3
<b>Panel antennas</b>						
A24-P8SF	Flat Panel	8.5	Fixed	2 m	2.8	4.5
A24-P8NF	Flat Panel	8.5	Fixed	2 m	2.8	4.5
A24-P13NF	Flat Panel	13.0	Fixed	2 m	7.3	9.0
A24-P14NF	Flat Panel	14.0	Fixed	2 m	8.3	10.0
A24-P15NF	Flat Panel	15.0	Fixed	2 m	9.3	11.0
A24-P16NF	Flat Panel	16.0	Fixed	2 m	10.3	12.0
A24-P19NF	Flat Panel	19.0	Fixed	2 m	13.3	15.0
<b>Yagi antennas</b>						
A24-Y6NF	Yagi (6-element)	8.8	Fixed	2 m	2.4	4.2
A24-Y7NF	Yagi (7-element)	9.0	Fixed	2 m	2.6	4.4
A24-Y9NF	Yagi (9-element)	10.0	Fixed	2 m	3.6	5.4
A24-Y10NF	Yagi (10-element)	11.0	Fixed	2 m	4.6	6.4

Part Number	Type (Description)	Gain (dBi)	Application*	Min Separation	Required antenna cable loss (dB)	
					Channels 11-25	Channel 26
A24-Y12NF	Yagi (12-element)	12.0	Fixed	2 m	5.6	7.4
A24-Y13NF	Yagi (13-element)	12.0	Fixed	2 m	5.6	7.4
A24-Y15NF	Yagi (15-element)	12.5	Fixed	2 m	6.1	7.9
A24-Y16NF	Yagi (16-element)	13.5	Fixed	2 m	7.1	8.9
A24-Y16RM	Yagi (16-element, RPSMA connector)	13.5	Fixed	2 m	7.1	8.9
A24-Y18NF	Yagi (18-element)	15.0	Fixed	2 m	8.6	10.4



### XBee-PRO ZigBee TH RF module

The following table shows the antennas approved for use with the XBee-PRO ZigBee TH RF Module.

Part number	Type (description)	Gain (dBi)	Application*	Min. separation	Required antenna cable loss (dB)	
					Channels 11-25	Channel 26
<b>Integral antennas</b>						
29000294	Integral PCB antenna	-0.5	Fixed/Mobile	20 cm	N/A	N/A
A24-QI	Monopole (Integrated whip)	1.5	Fixed/Mobile	20 cm	N/A	N/A
<b>Dipole antennas</b>						
A24-HASM-450	Dipole (Half-wave articulated RPSMA - 4.5")	2.1	Fixed/Mobile	20 cm	N/A	N/A
A24-HABSM	Dipole (Articulated RPSMA)	2.1	Fixed	20 cm	N/A	N/A
29000095	Dipole (Half-wave articulated RPSMA - 4.5")	2.1	Fixed/Mobile	20 cm	N/A	N/A
A24-HABUF-P5I	Dipole (Half-wave articulated bulkhead mount U.F.L. w/ 5" pigtail)	2.1	Fixed	20 cm	N/A	N/A
A24-HASM-525	Dipole (Half-wave articulated RPSMA - 5.25")	2.1	Fixed/ Mobile	20 cm	N/A	N/A
<b>Omni-directional antennas</b>						
A24-F2NF	Omni-directional (Fiberglass base station)	2.1	Fixed/Mobile	20 cm	N/A	N/A
A24-F3NF	Omni-directional (Fiberglass base station)	3.0	Fixed/Mobile	20 cm	N/A	N/A
A24-F5NF	Omni-directional (Fiberglass base station)	5.0	Fixed	20 cm	N/A	N/A
A24-F8NF	Omni-directional (Fiberglass base station)	8.0	Fixed	2 m	N/A	N/A

Part number	Type (description)	Gain (dBi)	Application*	Min. separation	Required antenna cable loss (dB)	
					Channels 11-25	Channel 26
A24-F9NF	Omni-directional (Fiberglass base station)	9.5	Fixed	2 m	N/A	N/A
A24-F10NF	Omni-directional (Fiberglass base station)	10.0	Fixed	2 m	N/A	N/A
A24-F12NF	Omni-directional (Fiberglass base station)	12.0	Fixed	2 m	N/A	.9
A24-W7NF	Omni-directional (base station)	7.2	Fixed	2 m	N/A	N/A
A24-M7NF	Omni-directional (Mag-mount base station)	7.2	Fixed	2 m	N/A	N/A
A24-F15NF	Omni-directional (Fiberglass base station)	15.0	Fixed	2 m	2.5	3.9
<b>Panel antennas</b>						
A24-P8SF	Flat Panel	8.5	Fixed	2 m	1	1.6
A24-P8NF	Flat Panel	8.5	Fixed	2 m	1	1.6
A24-P13NF	Flat Panel	13	Fixed	2 m	5.5	6.1
A24-P14NF	Flat Panel	14	Fixed	2 m	6.5	7.1
A24-P15NF	Flat Panel	15.0	Fixed	2 m	7.5	8.1
A24-P16NF	Flat Panel	16.0	Fixed	2 m	8.5	9.1
A24-19NF	Flat Panel	19.0	Fixed	2 m	11.5	12.1
<b>Yagi antennas</b>						
A24-Y6NF	Yagi (6-element)	8.8	Fixed	2 m	.3	N/A
A24-Y7NF	Yagi (7-element)	9.0	Fixed	2 m	.5	N/A
A24-Y9NF	Yagi (9-element)	10.0	Fixed	2 m	1.5	1.0
A24-Y10NF	Yagi (10-element)	11.0 dBi	Fixed	2 m	2.5	2.0

Part number	Type (description)	Gain (dBi)	Application*	Min. separation	Required antenna cable loss (dB)	
					Channels 11-25	Channel 26
A24-Y12NF	Yagi (12-element)	12.0	Fixed	2 m	3.5	3.0
A24-Y13NF	Yagi (13-element)	12.0	Fixed	2 m	3.5	3.0
A24-Y15NF	Yagi (15-element)	12.5	Fixed	2 m	4.0	3.5
A24-Y16NF	Yagi (16-element)	13.5	Fixed	2 m	5.0	4.5
A24-Y16RM	Yagi (16-element, RPSMA connector)	13.5	Fixed	2 m	5.0	4.5
A24-Y18NF	Yagi (18-element)	15.0	Fixed	2 m	6.5	6.0

### XBee S2D SMT module

The following table shows the antennas approved for use with the XBee S2D SMT surface-mount module. See [Associated antenna descriptions](#) for additional cable loss required beyond the antennas listed below.

Part number	Type (Description)	Gain (dBi)	Application <sup>1</sup>	Min. Separation	Required Cable-lossor Power reduction from +8 dBm Channels 11 to 24	Required Cable-lossor Power reduction from +8 dBm Channel 25	Required Cable-lossor Power reduction from +1 dBm2 Channel 26
<b>Yagi Class Antennas</b>							
A24-Y6NF	Yagi (6-element)	8.8	Fixed	20 cm	0	0	5
A24-Y7NF	Yagi (7-element)	9.0	Fixed	20 cm	0	0	5
A24-Y9NF	Yagi (9-element)	10.0	Fixed	20 cm	0	0	6
A24-Y10NF	Yagi (10-element)	11.0	Fixed	20 cm	0	1	7
A24-Y12NF	Yagi (12-element)	12.0	Fixed	20 cm	0	2	8
A24-Y13NF	Yagi (13-element)	12.0	Fixed	20 cm	0	2	8
A24-Y15NF	Yagi (15-element)	12.5	Fixed	20 cm	0	2.5	8.5
A24-Y16NF	Yagi (16-element)	13.5	Fixed	20 cm	0	3.5	9.5
A24-Y16RM	Yagi (16-element, RPSMA connector)	13.5	Fixed	20 cm	0	3.5	9.5
A24-Y18NF	Yagi (18-element)	15.0	Fixed	20 cm	0	5	11
<b>Omni-directional antennas</b>							
A24-F2NF	Omni-directional (Fiberglass base station)	2.1	Fixed/Mobile	20 cm	0	0	0

Part number	Type (Description)	Gain (dBi)	Application <sup>1</sup>	Min. Separation	Required Cable-lossor Power reduction from +8 dBm Channels 11 to 24	Required Cable-lossor Power reduction from +8 dBm Channel 25	Required Cable-lossor Power reduction from +1 dBm2 Channel 26
A24-F3NF	Omni-directional (Fiberglass base station)	3.0	Fixed/Mobile	20 cm	0	0	0
A24-F5NF	Omni-directional (Fiberglass base station)	5.0	Fixed/Mobile	20 cm	0	0	0
A24-F8NF	Omni-directional (Fiberglass base station)	8.0	Fixed	20 cm	0	0	0
A24-F9NF	Omni-directional (Fiberglass base station)	9.5	Fixed	20 cm	0	0	1.5
A24-F10NF	Omni-directional (Fiberglass base station)	10.0	Fixed	20 cm	0	0	2.5
A24-F12NF	Omni-directional (Fiberglass base station)	12.0	Fixed	20 cm	0	0	4.5
A24-F15NF	Omni-directional (Fiberglass base station)	15.0	Fixed	20 cm	0	0	7.5
A24-W7NF	Omni-directional (Base station)	7.2	Fixed	20 cm	0	0	0

Part number	Type (Description)	Gain (dBi)	Application <sup>1</sup>	Min. Separation	Required Cable-lossor Power reduction from +8 dBm Channels 11 to 24	Required Cable-lossor Power reduction from +8 dBm Channel 25	Required Cable-lossor Power reduction from +1 dBm <sup>2</sup> Channel 26
A24-M7NF	Omni-directional (Mag-mount base station)	7.2	Fixed	20 cm	0	0	0
<b>Dipole Antennas</b>							
A24-HASM-450	Dipole (Half-wave articulated RPSMA - 4.5")	2.1	Fixed/Mobile	20 cm	0	0	0
A24-HABSM	Dipole (Articulated RPSMA)	2.1	Fixed	20 cm	0	0	0
A24-HABUF-P5I	Dipole (Half-wave articulated bulkhead mount U.FL. w/ 5" pigtail)	2.1	Fixed	20 cm	0	0	0
A24-HASM-525	Dipole (Half-wave articulated RPSMA - 5.25")	2.1	Fixed	20 cm	0	0	0
<b>Panel class antennas</b>							
A24-P8SF	Flat Panel	8.5	Fixed	20 cm	0	0	5.5
A24-P8NF	Flat Panel	8.5	Fixed	20 cm	0	0	5.5
A24-P13NF	Flat Panel	13.0	Fixed	20 cm	0	2	10
A24-P14NF	Flat Panel	14.0	Fixed	20 cm	0	3	11
A24-P15NF	Flat Panel	15.0	Fixed	20 cm	0	4	12

Part number	Type (Description)	Gain (dBi)	Application <sup>1</sup>	Min. Separation	Required Cable-lossor Power reduction from +8 dBm Channels 11 to 24	Required Cable-lossor Power reduction from +8 dBm Channel 25	Required Cable-lossor Power reduction from +1 dBm <sup>2</sup> Channel 26
A24-P16NF	Flat Panel	16.0	Fixed	20 cm	0	5	13
A24-P19NF	Flat Panel	19.0	Fixed	20 cm	0	8	16
<b>Integral antennas</b>							
29000313	Integral PCB antenna	0.0	Fixed	20 cm	0	0	0

### Associated antenna descriptions

The following table shows the associated antenna descriptions.

Antenna type	Maximum gain allowed	Required minimum assembly and cable loss for maximum gain of antenna
Integral PCB	0.0 dBi	0.0 dB
Dipole	2.1 dBi	0.63 dB
Omni-directional	15.0 dBi	1.25 dB
Yagi	15.0 dBi	1.25 dB
Flat panel	19.0 dBi	1.25 dB

### RF exposure

If you are an integrating the XBee into another product, you must include the following Caution statement in OEM product manuals to alert users of FCC RF exposure compliance:



**CAUTION!** To satisfy FCC RF exposure requirements for mobile transmitting devices, a separation distance of 25 cm or more should be maintained between the antenna of this device and persons during device operation. To ensure compliance, operations at closer than this distance are not recommended. The antenna used for this transmitter must not be co-located in conjunction with any other antenna or transmitter.

### Europe

The XBee ZigBee modules (non-PRO versions only ) have been tested for use in several European countries. For a complete list, refer to [www.digi.com](http://www.digi.com).

If the XBee RF Modules are incorporated into a product, the manufacturer must ensure compliance of the final product with articles 3.1a and 3.1b of the R&TTE Directive. A Declaration of Conformity must be issued for each of these standards and kept on file as described in the R&TTE Directive.

Furthermore, the manufacturer must maintain a copy of the XBee user manual documentation and ensure the final product does not exceed the specified power ratings, antenna specifications, and/or installation requirements as specified in the user guide.

### OEM labeling requirements

The “CE” marking must be affixed to a visible location on the OEM product. The following figure shows CE labeling requirements.

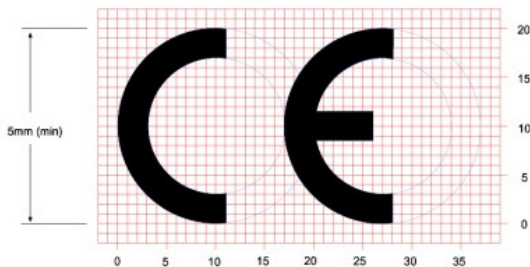



The CE mark shall consist of the initials “CE” taking the following form:

- If the CE marking is reduced or enlarged, the proportions given in the above graduated drawing must be respected.
- The CE marking must have a height of at least 5 mm except where this is not possible on account of the nature of the apparatus.
- The CE marking must be affixed visibly, legibly, and indelibly.

### **Important note**

Digi does not list the entire set of standards that must be met for each country. Digi customers assume full responsibility for learning and meeting the required guidelines for each country in their distribution market. Refer to the radio regulatory agency in the desired countries of operation for more information.

## **Declarations of conformity**

Digi has issued Declarations of Conformity for the XBee RF Modules concerning emissions, EMC, and safety. For more information, see <http://www.digi.com/resources/certifications>.

## **Antennas**

The following antennas have been tested and approved for use with the XBee ZigBee RF Module:

- Dipole (2.1 dBi, Omni-directional, Articulated RPSMA, Digi part number A24-HABSM)
- PCB Antenna (0.0 dBi)
- Monopole Whip (1.5 dBi)

# **IC (Industry Canada) Certification**

## **Labeling requirements**

Labeling requirements for Industry Canada are similar to those of the FCC. A clearly visible label on the outside of the final product enclosure must display the following text.

### **For XBee ZB surface-mount:**

Contains Model XBee S2C Radio, IC: 1846A-XBS2C

The integrator is responsible for its product to comply with IC ICES-003 & FCC Part 15, Sub. B - Unintentional Radiators. ICES-003 is the same as FCC Part 15 Sub. B and Industry Canada accepts FCC test report or CISPR 22 test report for compliance with ICES-003.

### **For XBee-PRO ZB surface-mount:**

Contains Model PS2CSM Radio, IC: 1846A-PS2CSM

The integrator is responsible for its product to comply with IC ICES-003 & FCC Part 15, Sub. B - Unintentional Radiators. ICES-003 is the same as FCC Part 15 Sub. B and Industry Canada accepts FCC test report or CISPR 22 test report for compliance with ICES-003.

---

**Note** Legacy XBee-PRO SMT (Model: PRO S2C; hardware version 21xx) has IC: 1846A-XBPS2C.

---

### For XBee ZB through-hole:

Contains Model S2CTH Radio, IC: 1846A-S2CTH

The integrator is responsible for its product to comply with IC ICES-003 & FCC Part 15, Sub. B - Unintentional Radiators. ICES-003 is the same as FCC Part 15 Sub. B and Industry Canada accepts FCC test report or CISPR 22 test report for compliance with ICES-003.

### For XBee-PRO ZB through-hole:

Contains Model PS2CTH Radio, IC: 1846A-PS2CTH

The integrator is responsible for its product to comply with IC ICES-003 & FCC Part 15, Sub. B - Unintentional Radiators. ICES-003 is the same as FCC Part 15 Sub. B and Industry Canada accepts FCC test report or CISPR 22 test report for compliance with ICES-003.

### Transmitters for detachable antennas

This device has been designed to operate with the antennas listed in the previous table and having a maximum of 19 dB. Antennas not included in this list or having a gain greater than 19 dB are strictly prohibited for use with this device. The required antenna impedance is 50 ohms.

### Detachable antenna

To reduce potential radio interference to other users, the antenna type and gain should be so chosen that the equivalent, isotropically radiated power (EIRP) is not more than permitted for successful communication.

### For XBee S2D SMT:

Contains Model S2D SMT, IC: 1846A-S2DSM

The integrator is responsible for its product to comply with IC ICES-003 & FCC Part 15, Sub. B - Unintentional Radiators. ICES-003 is the same as FCC Part 15 Sub. B and Industry Canada accepts FCC test report or CISPR 22 test report for compliance with ICES-003.

This device complies with Industry Canada licence-exempt RSS standard(s). Operation is subject to the following two conditions: (1) this device may not cause interference, and (2) this device must accept any interference, including interference that may cause undesired operation of the device.

Le présent appareil est conforme aux CNR d'Industrie Canada applicables aux appareils radio exempts de licence. L'exploitation est autorisée aux deux conditions suivantes: (1) l'appareil ne doit pas produire de brouillage, et (2) l'utilisateur de l'appareil doit accepter tout brouillage radioélectrique subi, même si le brouillage est susceptible d'en compromettre le fonctionnement.

### RF Exposure



**CAUTION!** This equipment is approved for mobile and base station transmitting devices only. Antenna(s) used for this transmitter must be installed to provide a separation distance of at least 20 cm from all persons and must not be co-located or operating in conjunction with any other antenna or transmitter.

---



**ATTENTION!** Cet équipement est approuvé pour la mobile et la station base dispositifs d'émission seulement. Antenne(s) utilisé pour cet émetteur doit être installé pour fournir

---

---

une distance de séparation d'au moins 20 cm à partir de toutes les personnes et ne doit pas être situé ou fonctionner en conjonction avec tout autre antenne ou émetteur.



---

### **Transmitters with Detachable Antennas**

This radio transmitter (IC: 1846A-S2DSM) has been approved by Industry Canada to operate with the antenna types listed in [FCC-approved antennas \(2.4 GHz\)](#) with the maximum permissible gain and required antenna impedance for each antenna type indicated. Antenna types not included in this list, having a gain greater than the maximum gain indicated for that type, are strictly prohibited for use with this device.

Le présent émetteur radio (IC: 1846A-S2DSM) a été approuvé par Industrie Canada pour fonctionner avec les types d'antenne énumérés ci-dessous et ayant un gain admissible maximal et l'impédance requise pour chaque type d'antenne. Les types d'antenne non inclus dans cette liste, ou dont le gain est supérieur au gain maximal indiqué, sont strictement interdits pour l'exploitation de l'émetteur.

### **Detachable Antenna**

Under Industry Canada regulations, this radio transmitter may operate using only an antenna of a type and maximum (or lesser) gain approved for the transmitter by Industry Canada. To reduce potential radio interference to other users, the antenna type and its gain should be so chosen that the equivalent isotropically radiated power (e.i.r.p.) is not more than that necessary for successful communication.

Conformément à la réglementation d'Industrie Canada, le présent émetteur radio peut fonctionner avec une antenne d'un type et d'un gain maximal (ou inférieur) approuvé pour l'émetteur par Industrie Canada. Dans le but de réduire les risques de brouillage radioélectrique à l'intention des autres utilisateurs, il faut choisir le type d'antenne et son gain de sorte que la puissance isotrope rayonnée équivalente (p.i.r.e.) ne dépasse pas l'intensité nécessaire à l'établissement d'une communication satisfaisante.

## **Australia (RCM)**

Only XBee S2C and XBee-PRO S2C modules comply with requirements to be used in end products in Australia and New Zealand. All products with EMC and radio communications must have registered RCM and R-NZ marks. Registration to use the compliance mark will only be accepted from Australia or New Zealand manufacturers or importers, or their agents.

In order to have a RCM or R-NZ mark on an end product, a company must comply with a or b below.

- a. have a company presence in Australia or New Zealand.
- b. have a company/distributor/agent in Australia or New Zealand that will sponsor the importing of the end product.

Contact Digi for questions related to locating a contact in Australia and New Zealand.

## **ANATEL (Brazil) certification**



The XBee ZB RF devices comply with Brazil ANATEL standards in Resolution No. 506. The following information is required in the user manual for the product containing the radio and on the product containing the radio (in Portuguese):



Digi Model: XB24CZ7PIS-004, XB24CZ7PISB003, XB24CZ7RIS-004, XB24CZ7RISB003, XB24CZ7UIS-004 e XB24CZ7UISB003



Este equipamento opera em caráter secundário, isto é, não tem direito a proteção contra interferência prejudicial, mesmo de estações do mesmo tipo, e não pode causar interferência a sistemas operando em caráter primário.

<b>Modelo:</b>	<b>PS2CSM</b>
<b>PNs:</b>	<b>XBP24CZ7PIS-004, XBP24CZ7PISB003, XBP24CZ7RIS-004, XBP24CZ7RISB003, XBP24CZ7UIS-004 XBP24CZ7UISB003.</b>

	<b>1533-15-1209</b>
	 <b>(01)07899029305721</b>
<p>Este equipamento opera em caráter secundário, isto é, não tem direito a proteção contra interferência prejudicial, mesmo de estações do mesmo tipo, e não pode causar interferência a sistemas operando em caráter primário.</p>	

<b>Model:</b>	<b>PS2CTH</b>
<b>Part Number</b>	XBP24CZ7PIT-004, XBP24CZ7PITB003, XBP24CZ7WIT-004, XBP24CZ7WITB003, XBP24CZ7SIT-004, XBP24CZ7SITB003, XBP24CZ7UIT-004, XBP24CZ7UITB003
	<b>4077-15-1209</b>  <b>(01)07899029305967</b>
Este equipamento opera em caráter secundário, isto é, não tem direito a proteção contra interferência prejudicial, mesmo de estações do mesmo tipo, e não pode causar interferência a sistemas operando em caráter primário.	

<b>Model:</b>	<b>S2CTH</b>
<b>Part Number</b>	XB24CZ7PIT-004, XB24CZ7PITB003, XB24CZ7WIT-004, XB24CZ7WITB003, XB24CZ7SIT-004, XB24CZ7SITB003, XB24CZ7UIT-004, XB24CZ7UITB003
	<b>4556-15-1209</b>  <b>(01)07899029306018</b>
Este equipamento opera em caráter secundário, isto é, não tem direito a proteção contra interferência prejudicial, mesmo de estações do mesmo tipo, e não pode causar interferência a sistemas operando em caráter primário.	

## Migrating from XBee through-hole to XBee surface-mount devices

---

The XBee surface-mount and through-hole devices are designed to be compatible and offer the same basic feature set. As mentioned previously, the surface-mount form factor has more I/O pins.

This section provides information to help users migrate from the surface-mount to the Through-hole form factor.

Pin mapping .....	287
Mounting .....	288

## Pin mapping

Mapping of the surface-mount (SMT) pads to the through-hole (TH) pins is shown in the table below. The pin names are from the S2C SMT device.

SMT Pin #	Name	TH Pin #
1	GND	
2	V <sub>CC</sub>	1
3	DOUT / DIO13	2
4	DIN / $\overline{\text{CONFIG}}$ / DIO14	3
5	DIO12	4
6	$\overline{\text{RESET}}$	5
7	RSSI PWM / DIO10	6
8	PWM1 / DIO11	7
9	[reserved]	8
10	$\overline{\text{DTR}}$ / SLEEP_RQ / DIO8	9
11	GND	10
12	SPI_ATT $\overline{\text{N}}$ / $\overline{\text{BOOTMODE}}$ / DIO19	
13	GND	
14	SPI_CLK / DIO18	
15	SPI_SSEL $\overline{\text{}}$ / DIO17	
16	SPI_MOSI / DIO16	
17	SPI_MISO / DIO15	
18	[reserved]	
19	[reserved]	
20	[reserved]	
21	[reserved]	
22	GND	
23	[reserved]	
24	DIO4	11
25	$\overline{\text{CTS}}$ / DIO7	12
26	ON / $\overline{\text{SLEEP}}$ / DIO9	13
27	V <sub>REF</sub>	14

SMT Pin #	Name	TH Pin #
28	ASSOCIATE / DIO5	15
29	$\overline{\text{RTS}}$ / DIO6	16
30	AD3 / DIO3	17
31	AD2 / DIO2	18
32	AD1 / DIO1	19
33	AD0 / DIO0	20
34	[reserved]	
35	GND	
36	RF	
37	[reserved]	

## Mounting

One important difference between the surface-mount and the through-hole devices is how they mount to the PCB. Different mounting techniques are required.

Digi International has designed a footprint that allows either device to be attached to a PCB as shown in the following diagram. The dimensions without brackets are in inches, and those in brackets are in millimeters.



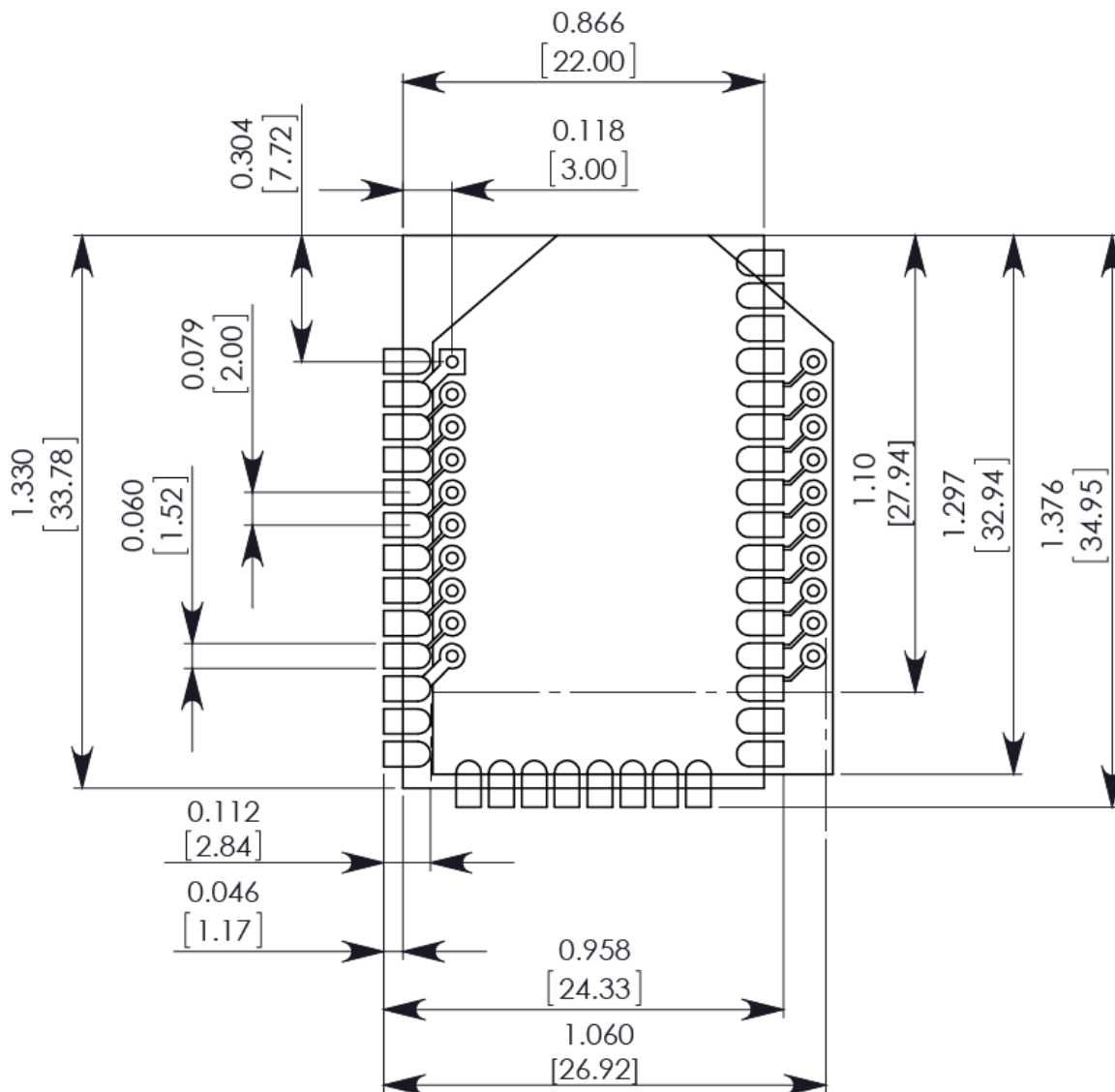

The round holes in the diagram are for the through-hole design, and the semi-oval pads are for the surface-mount design. Pin 1 of the through-hole design lines up with pad 1 of the surface-mount design, but the pins are actually offset by one pad (see [Pin mapping](#)). By using diagonal traces to connect the appropriate pins, the layout works for both modules.

For information on attaching the SMT device, see [Manufacturing information](#).

## Manufacturing information

---

The XBee device is designed for surface-mount on the OEM PCB. It has castellated pads to allow for easy solder attach inspection. The pads are all located on the edge of the device so there are no hidden solder joints on these devices.

Recommended solder reflow cycle .....	291
Recommended footprint .....	291
Flux and cleaning .....	293
Reworking .....	293

## Recommended solder reflow cycle

The following table lists the recommended solder reflow cycle. The chart shows the temperature setting and the time to reach the temperature.

Time (seconds)	Temperature (degrees C)
30	65
60	100
90	135
120	160
150	195
180	240
210	260

The maximum temperature should not exceed 260 degrees Celsius.

The device reflows during this cycle, and must not be reflowed upside down. Be careful not to jar the device while the solder is molten, as parts inside the device can be removed from their required locations.

Hand soldering is possible and should be done in accordance with approved standards.

The XBee/XBee-PRO ZB RF Modules are level 3 Moisture Sensitive Devices. When using this kind of device, consider the relative requirements in accordance with standard IPC/JEDEC J-STD-020.

In addition, note the following conditions:

- a. Calculated shelf life in sealed bag: 12 months at <40°C and <90% relative humidity (RH).
- b. Environmental condition during the production: 30°C /60% RH according to IPC/JEDEC J-STD - 033C, paragraphs 5 through 7.
- c. The time between the opening of the sealed bag and the start of the reflow process cannot exceed 168 hours if condition b) is met.
- d. Baking is required if conditions b) or c) are not met.
- e. Baking is required if the humidity indicator inside the bag indicates a RH of 10% more.
- f. If baking is required, bake modules in trays stacked no more than 10 high for 4-6 hours at 125°C.

## Recommended footprint

Digi recommends that you use the following PCB footprint for surface-mounting. The dimensions without brackets are in inches, and those in brackets are in millimeters.

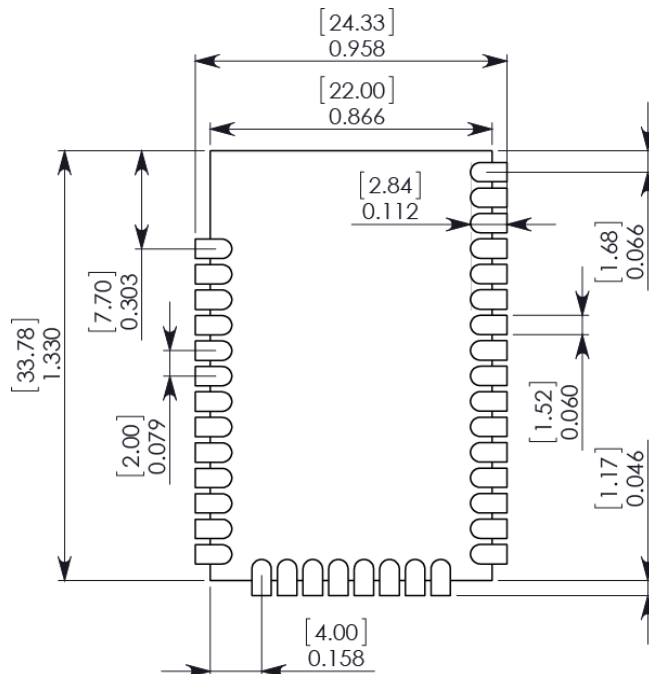

Match the solder footprint to the copper pads, but may need to be adjusted depending on the specific needs of assembly and product standards. Recommended stencil thickness is 0.15mm/0.005". Place the component last and set the placement speed to the slowest setting.

While the underside of the device is mostly coated with solder resist, we recommended the copper layer directly below the device be left open to avoid unintended contacts. Copper or vias must not interfere with the three exposed RF test points on the bottom of the device as shown in the following diagram. These devices have a ground plane in the middle on the back side for shielding purposes, which can be affected by copper traces directly below the device.

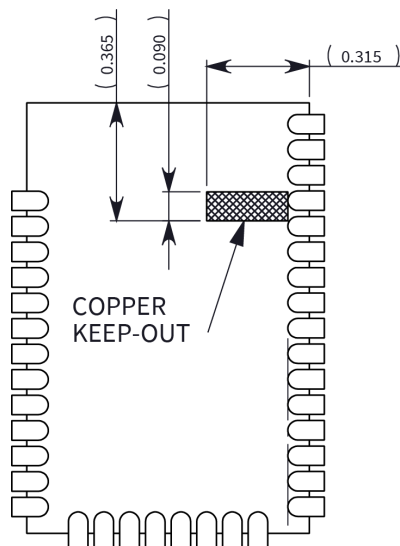

## Flux and cleaning

Digi recommends that a “no clean” solder paste be used in assembling these devices. This eliminates the clean step and ensures unwanted residual flux is not left under the device where it is difficult to remove.

In addition the following issues can occur:

- Cleaning with liquids can result in liquid remaining under the shield or in the gap between the device and the OEM PCB. This can lead to unintended connections between pads on the device.
- The residual moisture and flux residue under the device are not easily seen during an inspection process.

Factory recommended best practice is to use a “no clean” solder paste to avoid these issues and ensure proper device operation.

## Reworking

Never perform rework on the device itself. The device has been optimized to give the best possible performance, and reworking the device itself will void warranty coverage and certifications. We recognize that some customers choose to rework and void the warranty. The following information serves as a guideline in such cases to increase the chances of success during rework, though the warranty is still voided.

The device may be removed from the OEM PCB by the use of a hot air rework station, or hot plate. Be careful not to overheat the device. During rework, the device temperature may rise above its internal solder melting point and care should be taken not to dislodge internal components from their intended positions.

## Load ZB firmware on 802.15.4 devices

---

Background .....	295
Load ZB firmware .....	296

## Background

Our XBee/XBee-PRO 802.15.4 RF modules are built on the same hardware as the XBee/XBee-PRO S2C ZB RF Modules. It is possible to load ZigBee firmware on existing 802.15.4 modules. The “XBee/XBee-PRO S2C 802.15.4 part numbers” table shows which part numbers are compatible with ZigBee firmware.

ZigBee modules are approved for operation in some regions that 802.15.4 modules are not (see the table below). If your region is not listed as certified for the 802.15.4 module you purchased, it may be illegal for you to operate in your region, even if you load ZigBee firmware onto the module, because it is not labeled with the appropriate certification markings. Please check with local laws or your regional Digi International representative for more information.

Module name	Approved regions
XBee S2C ZigBee	USA, Canada, Europe, Australia/New Zealand, Brazil, and Japan
XBee-PRO S2C ZigBee	USA, Canada, Australia/New Zealand, and Brazil
XBee S2C 802.15.4	USA, Canada, Europe
XBee-PRO S2C 802.15.4	USA, Canada



**CAUTION!** The antenna cable loss requirements for the 802.15.4 firmware are different than the ZigBee firmware for gain antennas exceeding 2.1 dBi. If you migrate an 802.15.4 device to ZigBee firmware, and are using gain antennas, you must adhere to the cable loss requirements found in [Certifications](#).

XBee/XBee-PRO S2C 802.15.4 part numbers	Form factor	Hardware version (HV)
XB24CAPIS-004 XB24CARIS-004 XB24CAUIS-004	XBee SMT	0x22
XB24CAPIT-004 XB24CASIT-004 XB24CAUIT-004 XB24CAWIT-004	XBee TH	0x2E
XBP24CAPIS-004 XBP24CARIS-004 XBP24CAUIS-004	XBee SMT	0x30
XBP24CAPIT-004 XBP24CASIT-004 XBP24CAUIT-004 XBP24CAWIT-004	XBee TH	0x2D

In addition to the differences between the 802.15.4 and ZigBee protocols, some of the operational features are different between the two firmware versions. For example, the XBee-PRO 802.15.4 supports fewer channels than the ZigBee firmware. It is important that you read and understand this user guide before developing with the ZigBee firmware.

## Load ZB firmware

To load ZB firmware on an existing 802.15.4 module, use the following instructions. You must use the serial interface to perform this update. The device does not support OTA updates for changing 802.15.4 to ZB firmware or vice versa.

1. Verify that your device's part number (listed on the label) is included in the list shown in the table above.
2. Install the device in a Digi development board and connect it to your PC.
3. The next steps involve loading firmware using XCTU. To download XCTU and read detailed instructions about it, go to:  
<http://www.digi.com/products/xbee-rf-solutions/xctu-software/xctu>
4. When you get to the **Update firmware** dialog box, in the **Function set** area, click the **ZIGBEE** option, and the newest firmware version.
5. Click **Update** and follow the instructions.
6. When the updating process successfully completes, your device runs ZB firmware. You can change back to 802.15.4 firmware at any time by following the same process and selecting the 802.15.4 firmware option instead.



## Definitions

---

This section provides definitions of the ZigBee node types and protocols.

### ZigBee node types

Node	Description
Coordinator	<p>A node that has the unique function of forming a network. The coordinator is responsible for establishing the operating channel and PAN ID for an entire network. Once established, the coordinator can form a network by allowing routers and end devices to join. Once the network is formed, the coordinator functions like a router. It can participate in routing packets and be a source or destination for data packets.</p> <ul style="list-style-type: none"><li>■ One coordinator per PAN</li><li>■ Establishes/Organizes PAN</li><li>■ Can route data packets to/from other nodes</li><li>■ Can be a data packet source and destination</li><li>■ Mains-powered</li></ul> <p>Refer to <a href="#">ZigBee coordinator operation</a> for more information.</p>
Router	<p>A node that creates/maintains network information and uses this information to determine the best route for a data packet. A router must join a network before it can allow other routers and end devices to join. A router can participate in routing packets and is intended to be a mains-powered node.</p> <ul style="list-style-type: none"><li>■ Several routers can operate in one PAN</li><li>■ Can route data packets to/from other nodes</li><li>■ Can be a data packet source and destination</li><li>■ Mains-powered</li></ul> <p>Refer to <a href="#">ZigBee router operation</a> for more information.</p>
End device	<p>End devices must always interact with their parent to receive or transmit data. (See the "Joining" in the following table.) They are intended to sleep periodically and therefore have no routing capacity. An end device can be a source or destination for data packets but cannot route packets. End devices can be battery-powered and offer low-power operation.</p> <ul style="list-style-type: none"><li>■ Several end devices can operate in one PAN</li><li>■ Can be a data packet source and destination</li><li>■ All messages are relayed through a coordinator or router</li><li>■ Lower power modes</li></ul>

## ZigBee protocol

Protocol	Description
PAN	Personal Area Network - A data communication network that includes a coordinator and one or more routers/end devices.
Joining	The process of a node becoming part of a ZigBee PAN. A node becomes part of a network by joining to a coordinator or a router (that has previously joined to the network). During the process of joining, the node that allowed joining (the parent) assigns a 16-bit address to the joining node (the child).
Network address	The 16-bit address assigned to a node after it has joined to another node. The coordinator always has a network address of 0.
Operating channel	The frequency selected for data communications between nodes. The operating channel is selected by the coordinator on power-up.
Energy scan	A scan of RF channels that detects the amount of energy present on the selected channels. The coordinator uses the energy scan to determine the operating channel.
Route request	Broadcast transmission sent by a coordinator or router throughout the network in attempt to establish a route to a destination node.
Route reply	Unicast transmission sent back to the originator of the route request. It is initiated by a node when it receives a route request packet and its address matches the Destination Address in the route request packet.
Route reply	The process of establishing a route to a destination node when one does not exist in the Routing Table. It is based on the AODV (Ad-hoc On-demand Distance Vector routing) protocol.
ZigBee stack	ZigBee is a published specification set of high-level communication protocols for use with small, low- power modules. The ZigBee stack provides a layer of network functionality on top of the 802.15.4 specification. For example, the mesh and routing capabilities available to ZigBee solutions are absent in the 802.15.4 protocol.